

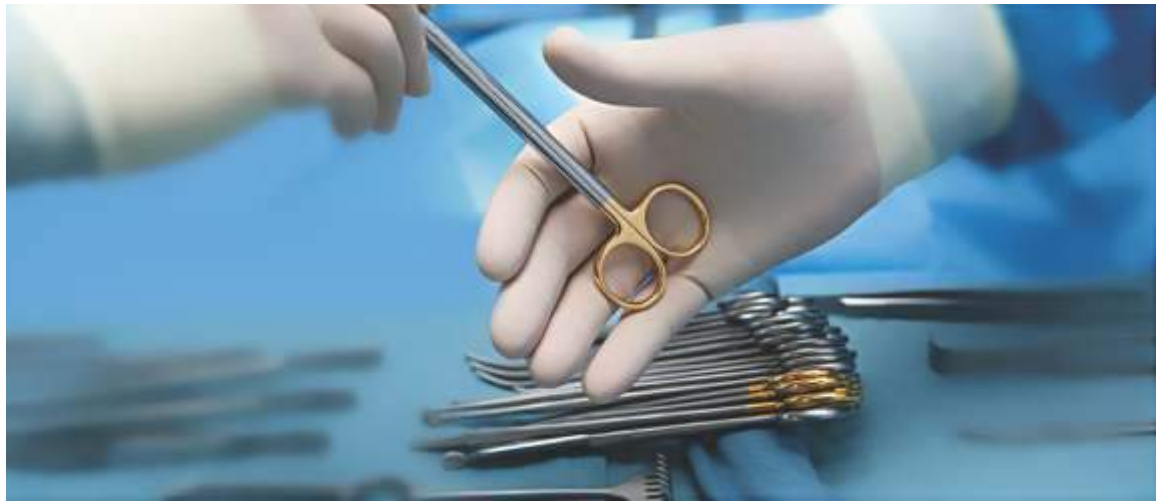
Friendly Specialist  
**SERVICE**

**FISON**  
Instruments

Professional  
**DENTAL**  
Instruments  
Range

[www.fisoninstruments.com](http://www.fisoninstruments.com)





## About Us

**FISON INSTRUMENTS** pride itself to be a company giving utmost assurance towards achieving our customer's trust. For us customer satisfaction comes first before any other desired organizational goals for which companies strive hard to accomplish.

**Fison Instruments** since formed we have witnessed rapid but consistent growth in our customer base and business volumes. We pride ourselves to be a reliable brand name having presence in three continents across the world. This has been achieved through our committed efforts to serve the requirements of our customers in best possible manner.

Through collaboration with surgeons, clinical technicians and nurses around the world, we identify surgical needs and advance them into effective and safe products.

## Special or Custom Designed Instruments

**FISON INSTRUMENTS** welcome the opportunity to manufacture instruments that are currently available, but are desired in an alternative tip/-handle selection or belong to special school of pattern. We produce custom designed instruments on your request as well. Please send us an actual sample and/or a detailed written description that includes all dimensions and measurements.

## FISON Dental Group Guarantee

Any product that fails within the expected lifetime of an instrument as a result of material defect or poor workmanship will be repaired or replaced at no charge. As a service, we also offer sharpening, repair or reworking of instruments. The **FISON INSTRUMENTS** customer service will be pleased to support and consult you in this regard.

We cannot be held responsible for the performance or replacement of any instrument that has been tampered with, modified or refitted in any manner.

## How to Place an Order

Instruments can only be ordered through our authorized dealer. Your surgical dealer will take your order and ship the products to you. If you have questions prior to placing an order or if you would like to place an order for any of our products, please contact us at [info@fisoninstruments.com](mailto:info@fisoninstruments.com)

[www.fisoninstruments.com](http://www.fisoninstruments.com)

01



Extracting Forceps

Page 01-20

02



Orthodontic  
Instruments

Page 21-35

03



Elevators

Page 36-42

04



Scissors

Page 43-47

05



Tweezers, Forceps  
& Needle Holders







Page 48-56

06







Implantology Instruments  
& Mouth Gags

Page 57-77

Page 78 - 118	Mirror Handles, Scalers & Knives		07
Page 119 - 133	Crown, Ligature & Laboratory Instruments		08
Page 134 - 138	Dental Syringes		09
Page 139 - 143	Impression Trays		10
Page 144 - 154	Hollow Ware		11
Page 155 - 157	Articulators		12



 +92 (309) 869 6436  
 [www.fisoninstruments.com](http://www.fisoninstruments.com)  
 [info@fisoninstruments.com](mailto:info@fisoninstruments.com)  
 Main Road, Fateh Garh, Sialkot - 51310 Pakistan



01

Page 1-20

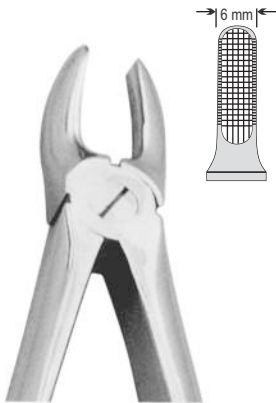
## Extraction / Estrazione

Extracting Forceps

Root Elevators

Luxators

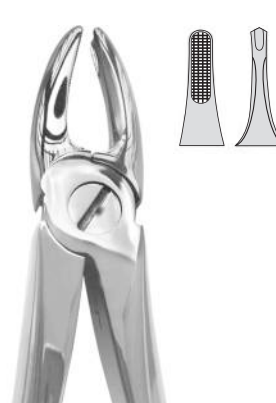
Periotomes



No. 1  
**FI-01-001**  
 Upper Centrals &  
 Canines / Cuspids



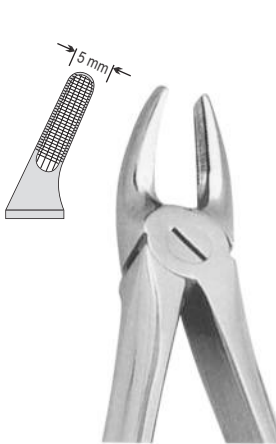
No. 2  
**FI-01-002**  
 Upper Laterals &  
 Canines / Cuspids



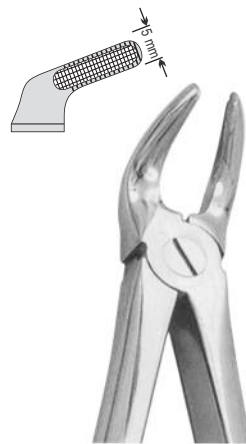
No. 3  
**FI-01-003**  
 Upper Incisors  
 & Canines



No. 4  
**FI-01-004**  
 Lower Incisors  
 & Cuspids



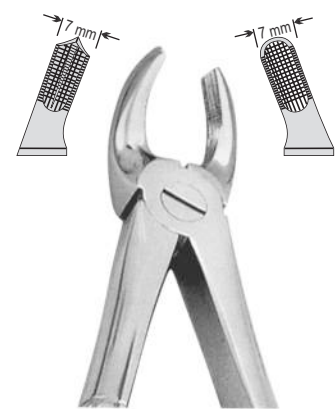
No. 7  
**FI-01-005**  
 Upper Premolars / Bicuspids



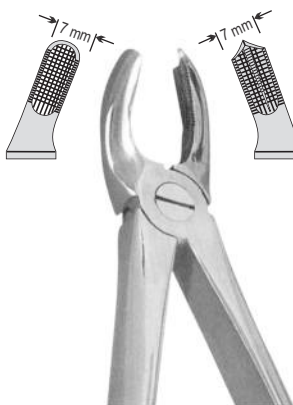
No. 8  
**FI-01-006**  
 Lower Premolars / Bicuspids



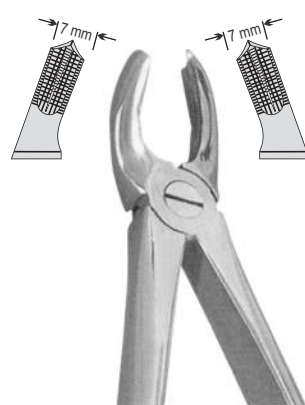
No. 13  
**FI-01-007**  
 Lower Premolars / Bicuspids



No. 17  
**FI-01-008**  
 Upper Molars, Right



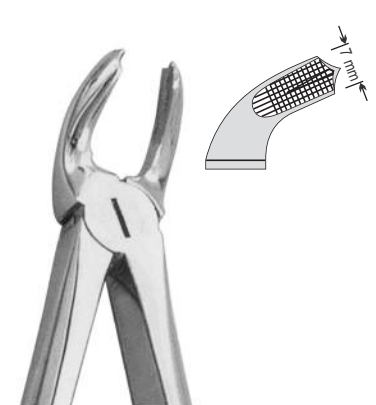
No. 18  
**FI-01-009**  
 Upper Molars, Left



No. 18A  
**FI-01-010**  
 Upper Molars



No. 19  
**FI-01-011**  
 Upper Third Molars



No. 21  
**FI-01-012**  
 Lower Molars

EXTRACTION FORCEPS STANDARD ENGLISH PATTERN  
 PINZE PER ESTRAZIONE MODELLO INGLESE STANDARD



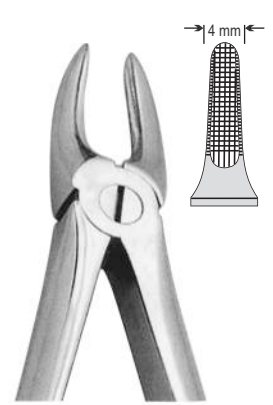
No. 22  
**FI-01-013**  
 Lower Molars



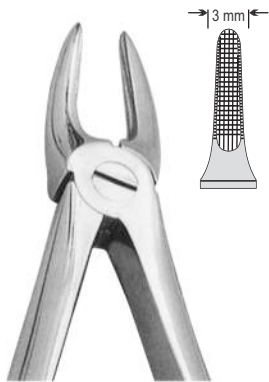
No. 23  
**FI-01-014**  
 Lower Molars  
 Right



No. 24  
**FI-01-015**  
 Lower Molars  
 Left



No. 29  
**FI-01-016**  
 Upper Roots



No. 29N  
**FI-01-017**  
 Upper Roots



No. 30  
**FI-01-018**  
 Upper Roots



No. 31  
**FI-01-019**  
 Lower Roots



No. 32  
**FI-01-020**  
 Lower Molars



No. 33  
**FI-01-021**  
 Lower Roots



No. 33A  
**FI-01-022**  
 Lower Roots

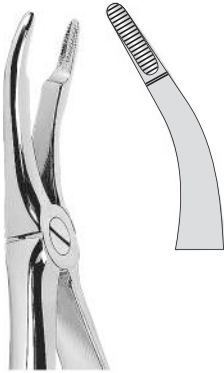


No. 33M  
**FI-01-023**  
 Lower Roots

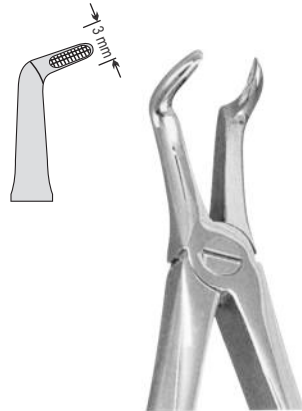


No. 41  
**FI-01-024**  
 Upper Roots

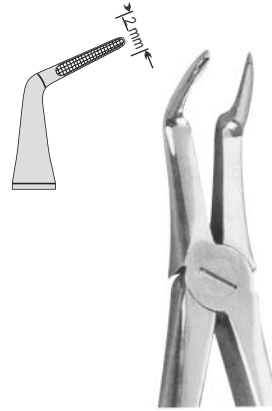




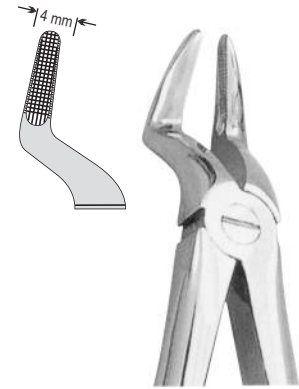
No. 44  
FI-01-025  
Upper Roots



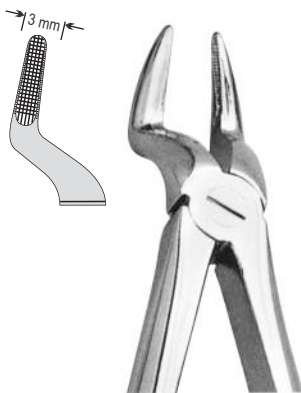
No. 45  
FI-01-026  
Lower Roots



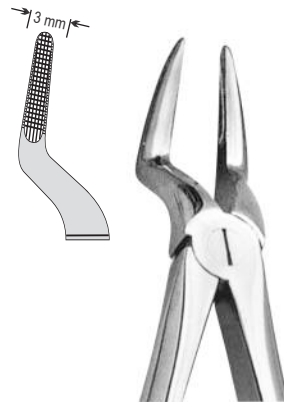
No. 46L  
FI-01-027  
Lower Roots



No. 51  
FI-01-028  
Upper Roots



No. 51A  
FI-01-029  
Upper Roots



No. 51M  
FI-01-030  
Upper Roots



No. 52  
FI-01-031  
Upper Roots



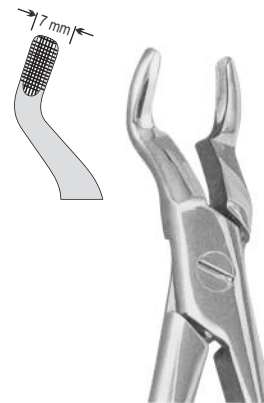
No. 52A  
FI-01-032  
Upper Teeth  
& Resection



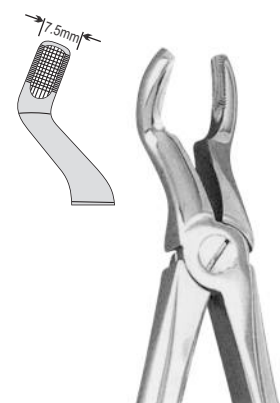
No. 55  
FI-01-033  
For Separating  
Upper Molars



No. 56  
FI-01-034  
For Separating  
Lower Molars



No. 67  
FI-01-035  
Upper Third  
Molars



No. 67A  
FI-01-036  
Upper Third  
Molars

EXTRACTION FORCEPS STANDARD ENGLISH PATTERN  
 PINZE PER ESTRAZIONE MODELLO INGLESE STANDARD



No. 68  
 FI-01-037  
 Lower Roots



No. 68A  
 FI-01-038  
 Lower Roots



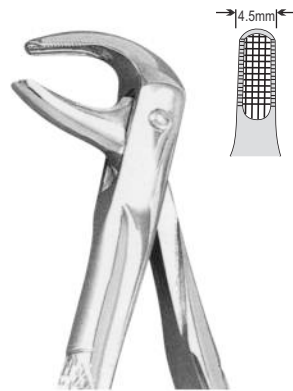
No. 73  
 FI-01-039  
 Lower Molars



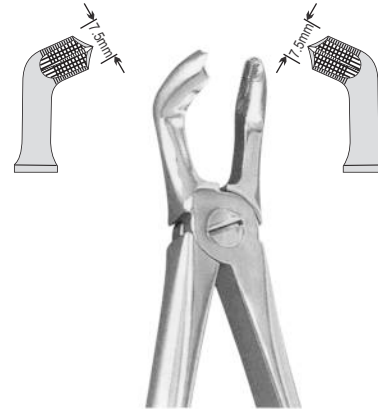
No. 74  
 FI-01-040  
 Lower Roots



No. 74N  
 FI-01-041  
 Lower Roots



No. 75  
 FI-01-042  
 Lower Premolars / Bicuspid



No. 79  
 FI-01-043  
 Lower Third Molars



No. 79A  
 FI-01-044  
 Lower Third Molars



No. 86A  
 FI-01-045  
 Lower Molars



No. 86C  
 FI-01-046  
 Lower Molars



No. 87  
 FI-01-047  
 Lower Molars



No. 89  
 FI-01-048  
 Right Upper Molars



No. 90  
 FI-01-049  
 Left Upper Molars



No. 91  
**FI-01-050**  
For Separating  
Lower Molars



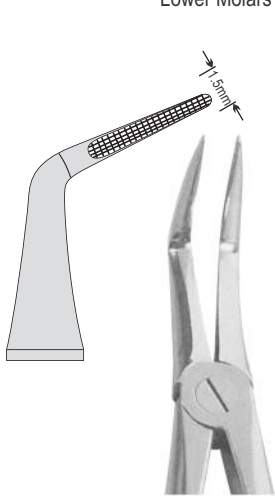
No. 99  
**FI-01-051**  
Lower Molars



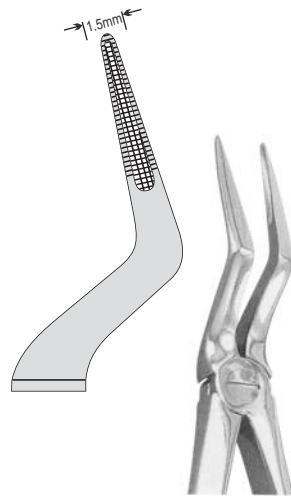
No. 99 1/4  
**FI-01-052**  
Lower Molars



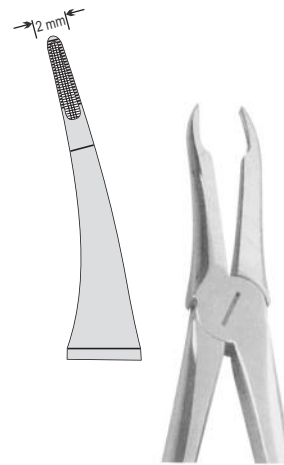
No. 99 1/2  
**FI-01-053**  
Lower Molars



No. 145  
**FI-01-054**  
Very Fine Roots  
Lower



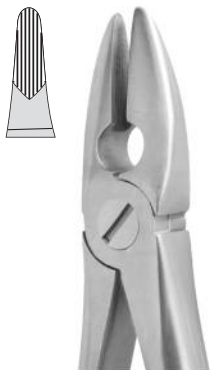
No. 151 1/2  
**FI-01-055**  
Very Fine Roots  
Upper



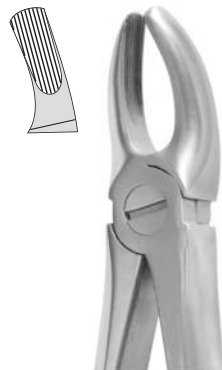
No. 349  
**FI-01-056**  
Very Fine Roots  
Upper



No. 359  
**FI-01-057**  
Very Fine Roots  
Lower



MD 1  
**FI-01-058**  
Incisors, Bicuspid & Roots  
Upper



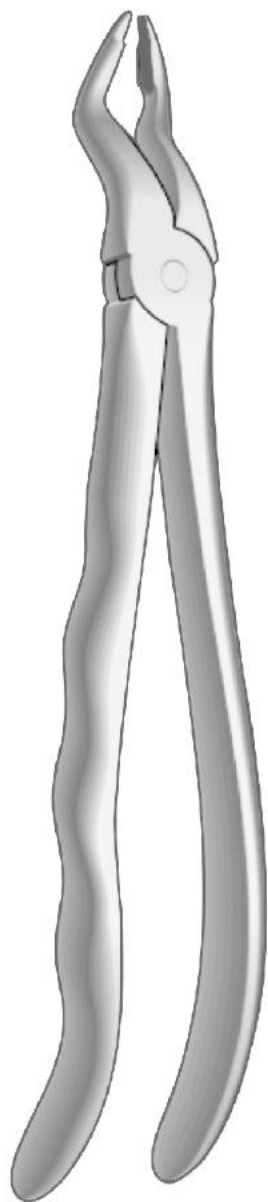
MD 2  
**FI-01-059**  
Upper Molars



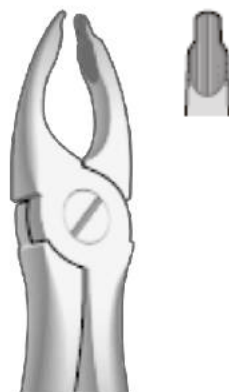
MD 3  
**FI-01-060**  
Incisors, Bicuspid & Roots  
Lower



MD 4  
**FI-01-061**  
Lower Molars



No. S-31  
**FI-01-062**  
 Upper Premolars



No. 34  
**FI-01-063**  
 Upper Incisors & Cuspids



No. 35  
**FI-01-064**  
 Upper Incisors & Cuspids,  
 Deep Gripping



No. 79N  
**FI-01-065**  
 Lower Wisdom Teeth



No. 46N  
**FI-01-066**  
 Lower Premolars



Fig. 36  
**FI-01-067**  
 Lower roots  
 Incisors & Cuspids

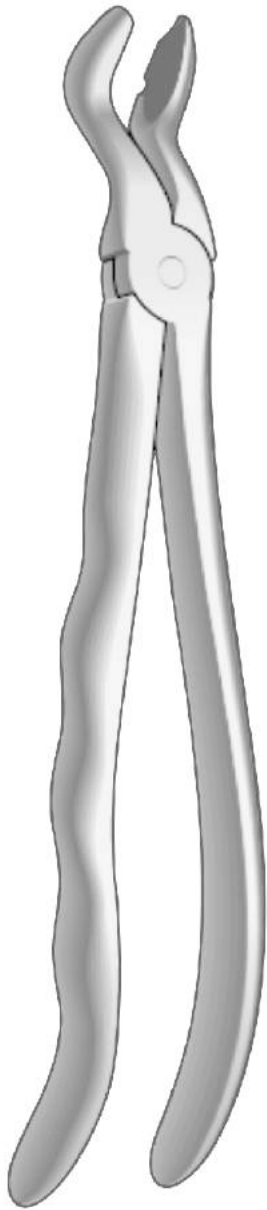


No. 36N  
**FI-01-068**  
 Lower roots  
 Incisors & Cuspids

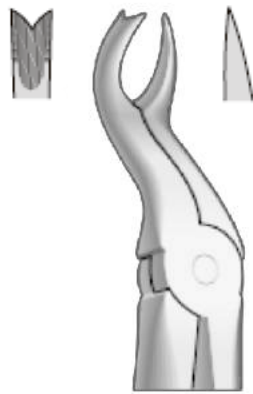


No. 59  
**FI-01-069**  
 Lower Root Fragments

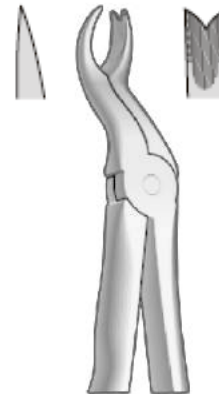




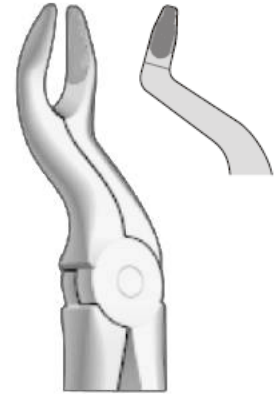
No. 80  
**FI-01-070**  
Felsch  
Upper Wisdom Teeth  
with Retaining Device



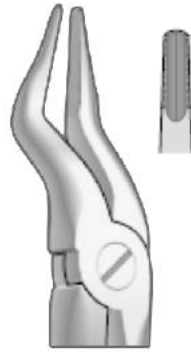
No. 67L  
**FI-01-071**  
Upper Molars  
Left



No. 67R  
**FI-01-072**  
Upper Molars  
Right



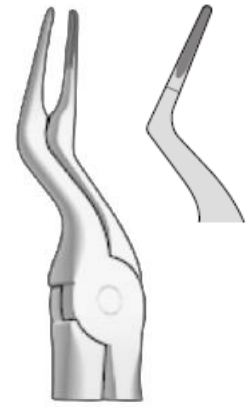
No. 67N  
**FI-01-073**  
Upper Molars



No. 51B  
**FI-01-074**  
Upper Molars



No. 97  
**FI-01-075**  
Upper Root Fragments



No. 97B  
**FI-01-076**  
Upper Root Fragments



No. 122 L  
**FI-01-077**  
Lower Molars & Wisdom Teeth  
Left



No. 122 R  
**FI-01-078**  
Lower Molars & Wisdom Teeth  
Right



No. 133 L  
**FI-01-079**  
Lower Very Fine Roots  
Left



No. 133 R  
**FI-01-080**  
Lower Very Fine Roots  
Right

EXTRACTION FORCEPS CHILDREN PATTERN  
PINZE PER ESTRAZIONE MODELLO BAMBINI



No. 13S  
FI-01-081  
Lower Premolars



No. 22S  
FI-01-082  
Lower Molars



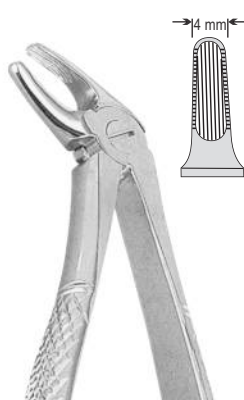
No. 30S  
FI-01-083  
Upper Roots



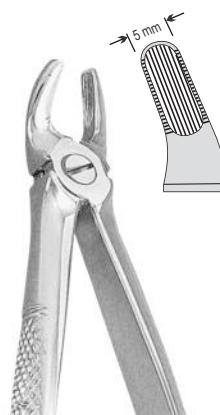
No. 33S  
FI-01-084  
Lower Roots



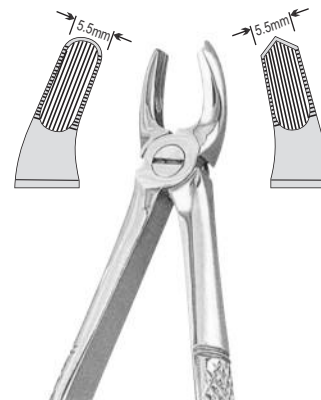
No. 37  
FI-01-085  
Upper Incisors



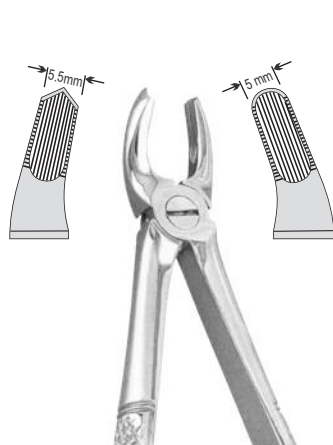
No. 38  
FI-01-086  
Lower Incisors and Canines



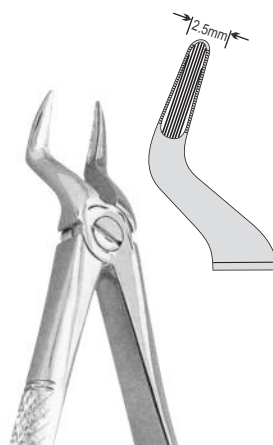
No. 39  
FI-01-087  
Upper Molars



No. 39L  
FI-01-088  
Upper Molars, left



No. 39R  
FI-01-089  
Upper Molars, Right



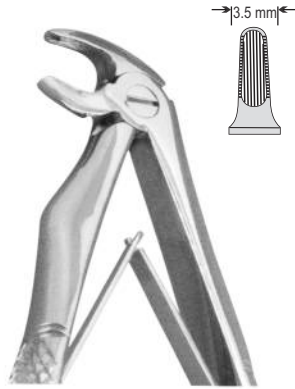
No. 51S  
FI-01-090  
Upper Roots



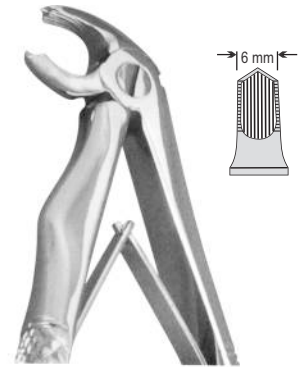
FI-01-091  
Set of 10 pieces



No. 52  
FI-01-092  
Upper Molars



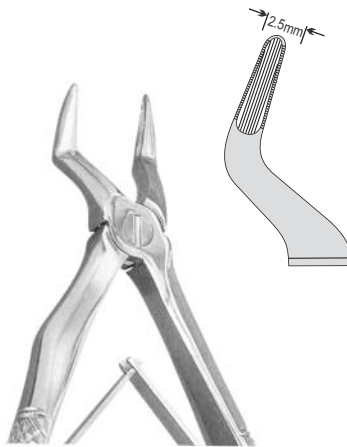
No. 13  
FI-01-093  
Lower Incisors



No. 22  
FI-01-094  
Lower Molars



No. 33  
FI-01-095  
Lower Roots



No. 51S  
FI-01-096  
Upper Roots



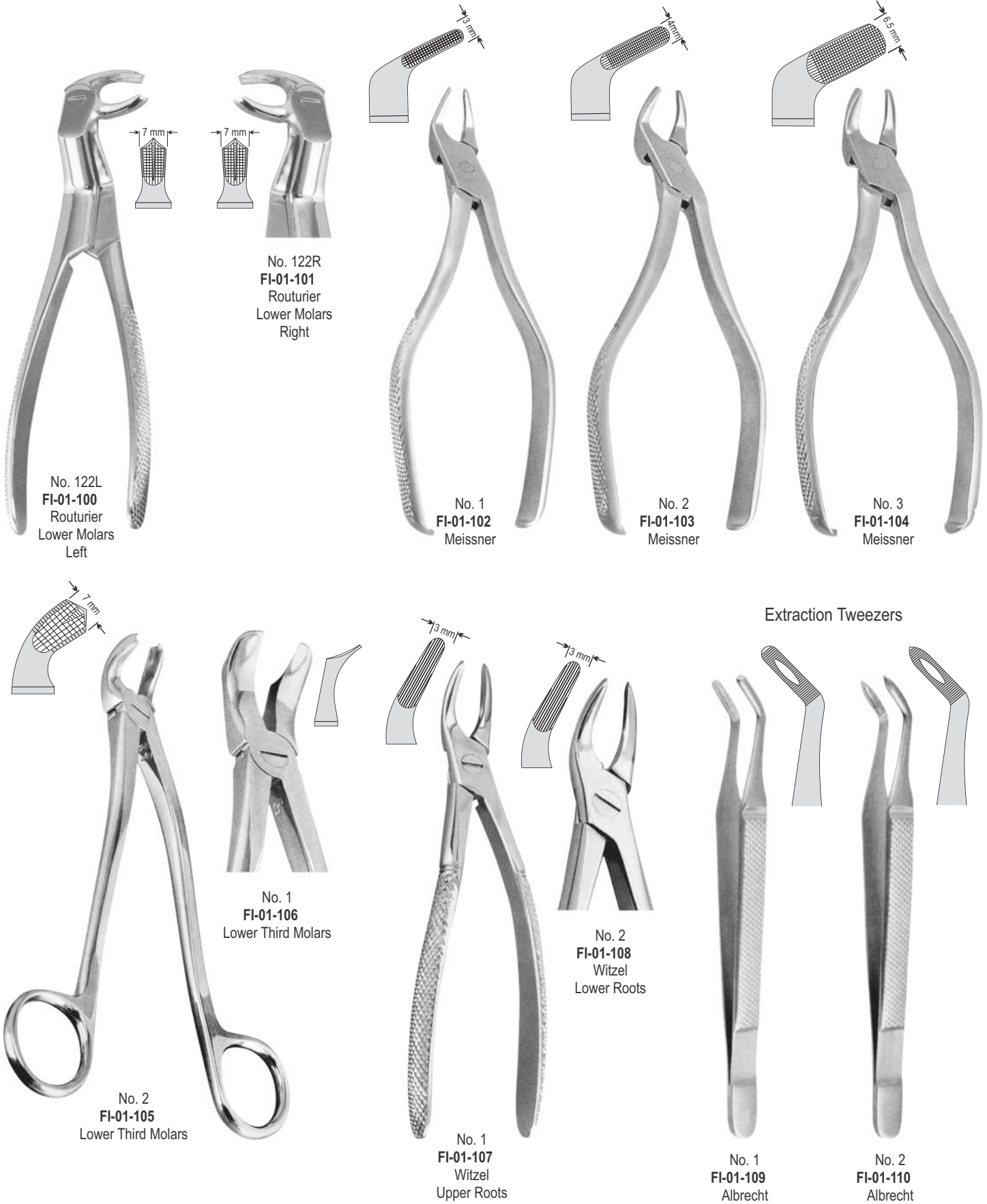
No. 137  
FI-01-097  
Upper Incisors



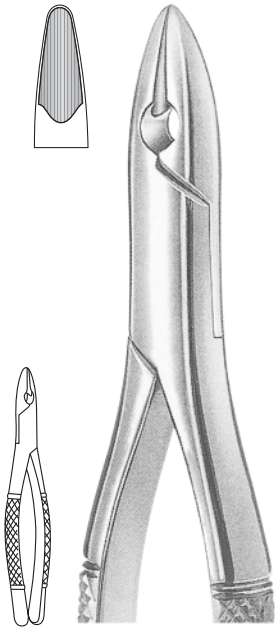
No. 7  
FI-01-098  
Upper Premolars



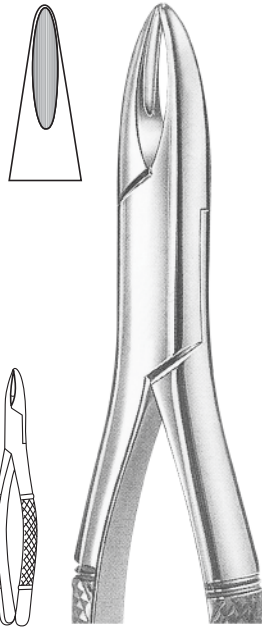
FI-01-099  
Set of 7 pieces







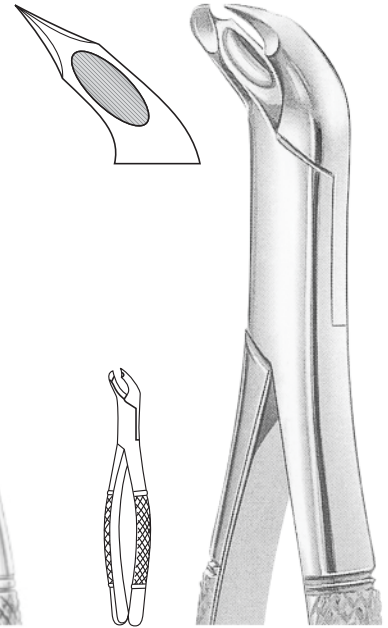
**FI-01-111**  
Upper incisors & cuspids



**FI-01-112**  
Upper incisors



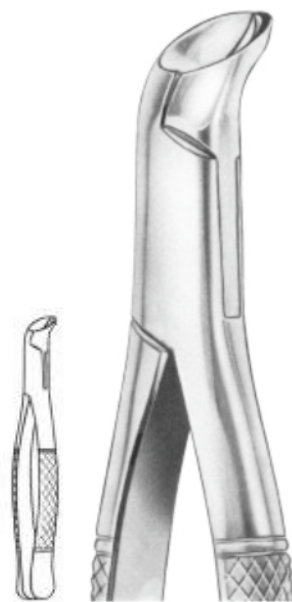
**FI-01-113**  
Upper & Lower Roots



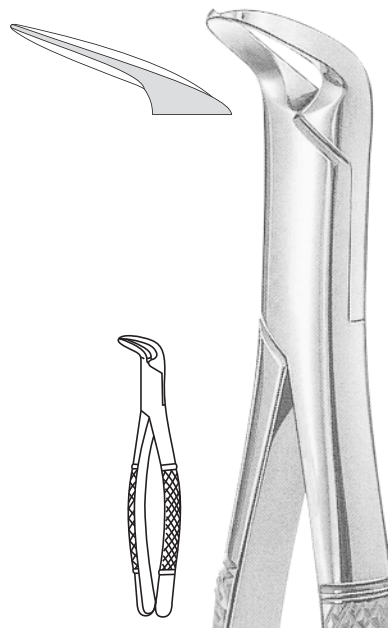
No. 3FS  
**FI-01-114**  
Lower molars



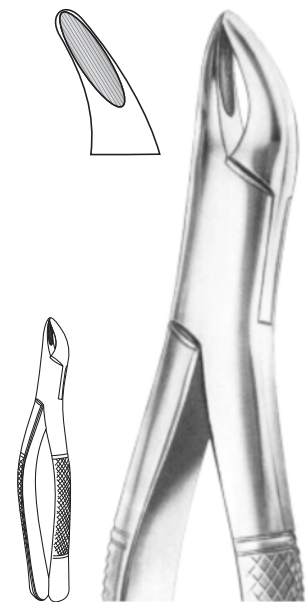
No. 4  
**FI-01-115**  
Upper & Lower Premolars



No. 5  
**FI-01-116**  
Lower third molars

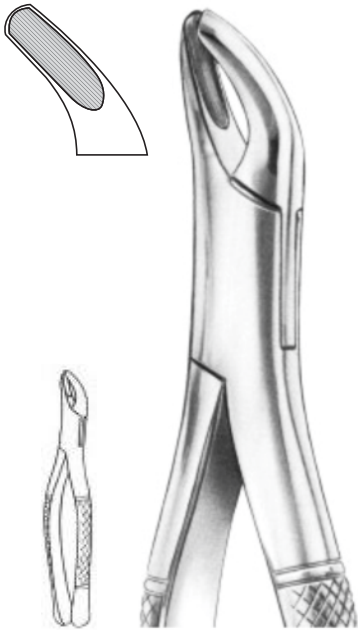


No. 6  
**FI-01-117**  
Splitting & Separating Forceps

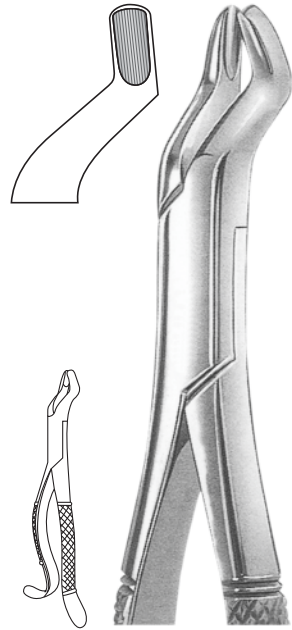


No. 7  
**FI-01-118**  
Upper Roots

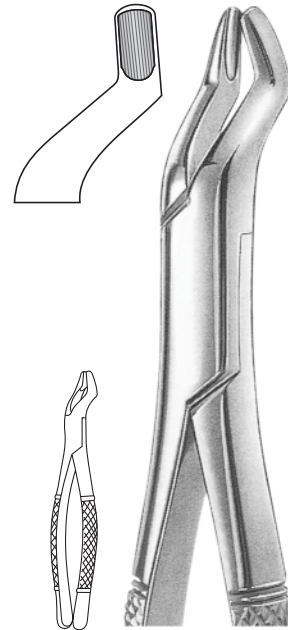
EXTRACTION FOCEPS "AMERICAN PATTERN"  
PINZA PER ESTRAZIONE "MODELLO AMERICANO"



No. 8  
**FI-01-119**  
Upper & Lower third molars



10 H  
**FI-01-120**  
Upper Molars, Hook Handle



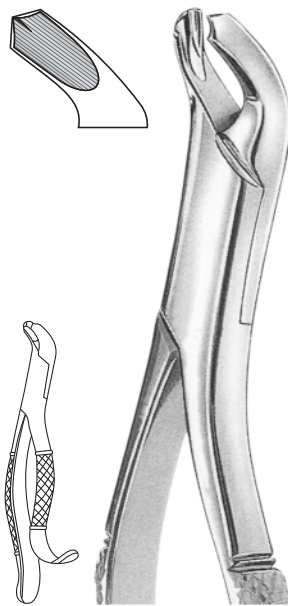
10 S  
**FI-01-121**  
Upper Molars



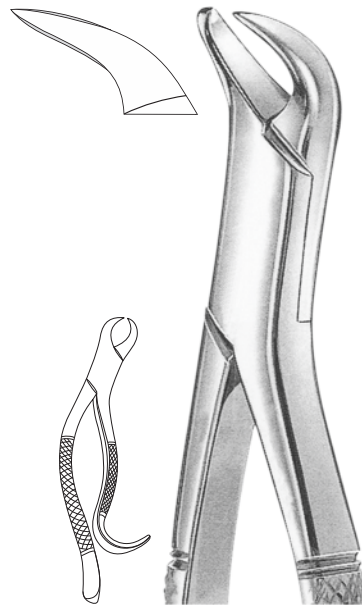
No. 13  
**FI-01-122**  
Upper Incisors



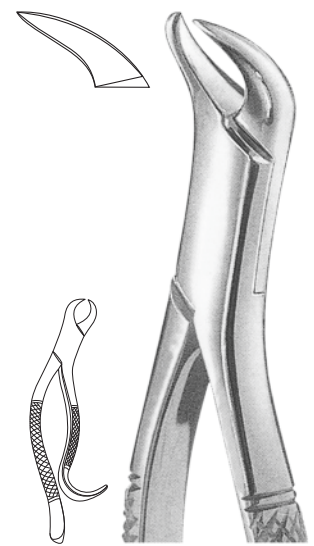
No. 14  
**FI-01-123**  
Lower Incisors



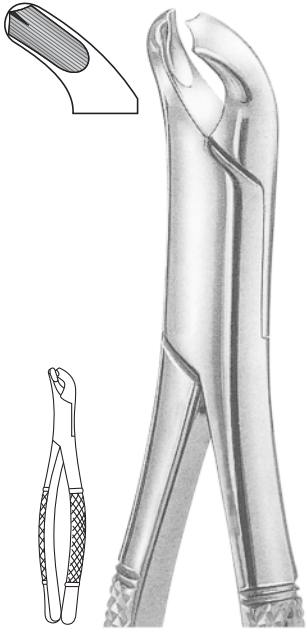
No. 15  
**FI-01-124**  
1st & 2nd Lower Molars



No. 16  
**FI-01-125**  
1st & 2nd Lower Molars



No. 16S  
**FI-01-126**  
Children, Lower Molars



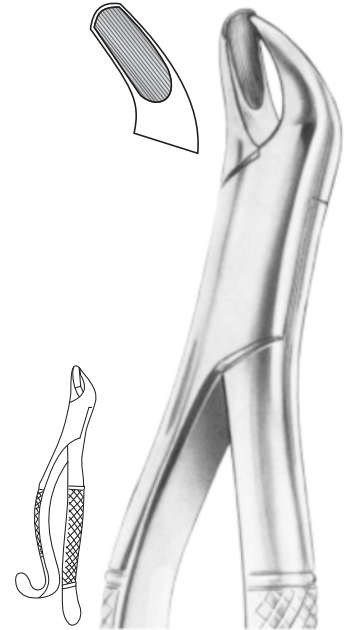
No. 17  
FI-01-127  
Gold Plated  
1st & 2nd Lower Molars



18L  
FI-01-128  
1st & 2nd Upper Molars, left



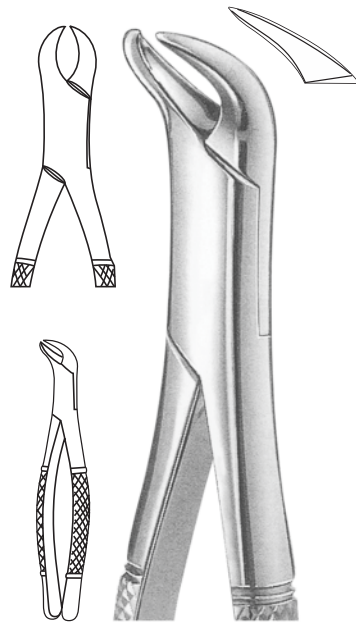
18R  
FI-01-129  
1st & 2nd Upper Molars, right



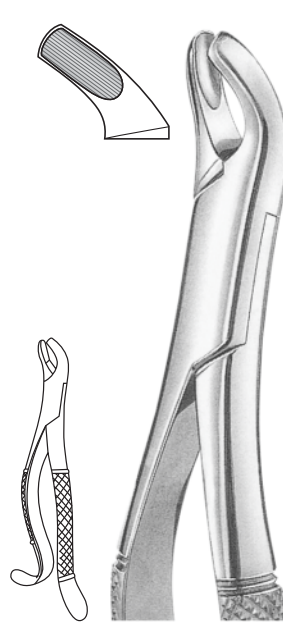
No. 20L  
FI-01-130  
Upper Molars left



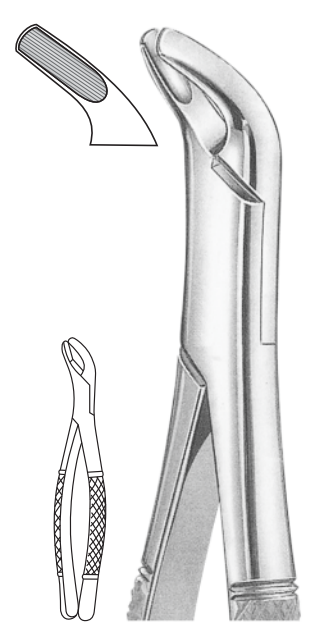
20R  
FI-01-131  
Upper Molars right



No. 23  
FI-01-132  
Lower Molars

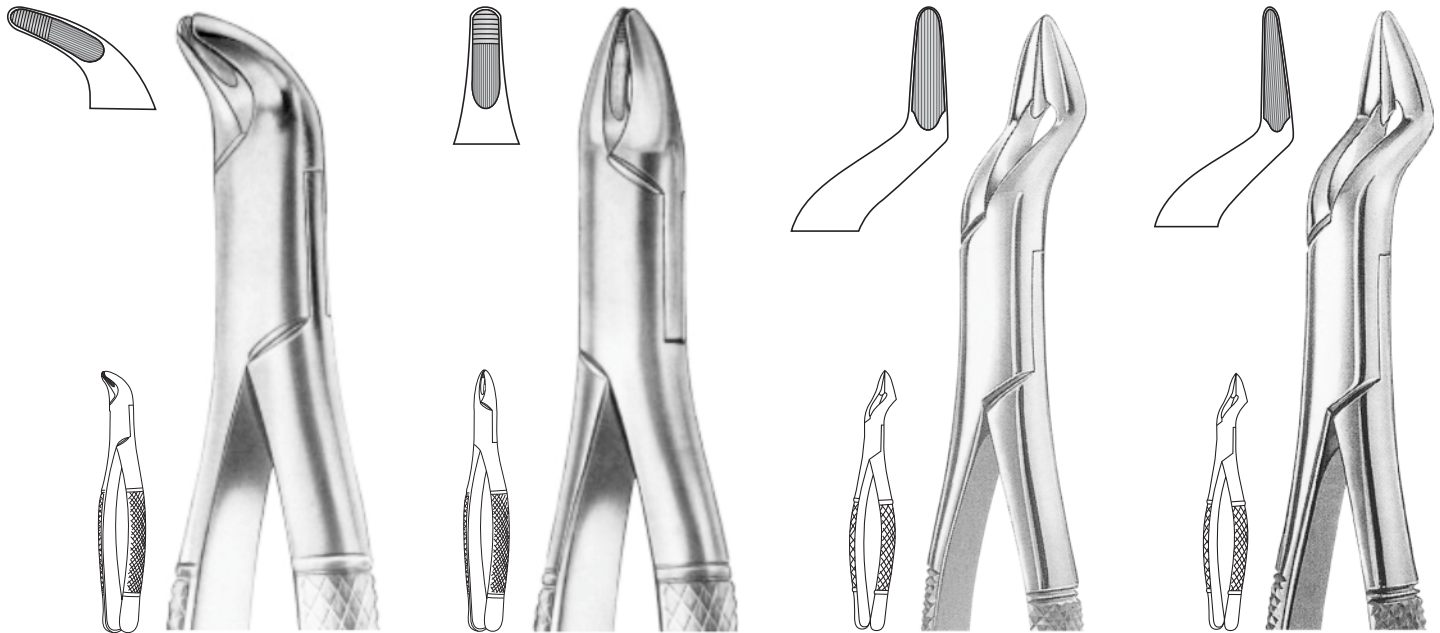


No. 24  
FI-01-133  
Upper Molars



No. 27  
FI-01-134  
Upper Molars

EXTRACTION FORCEPS "AMERICAN PATTERN"  
 PINZA PER ESTRAZIONE "MODELLO AMERICANO"

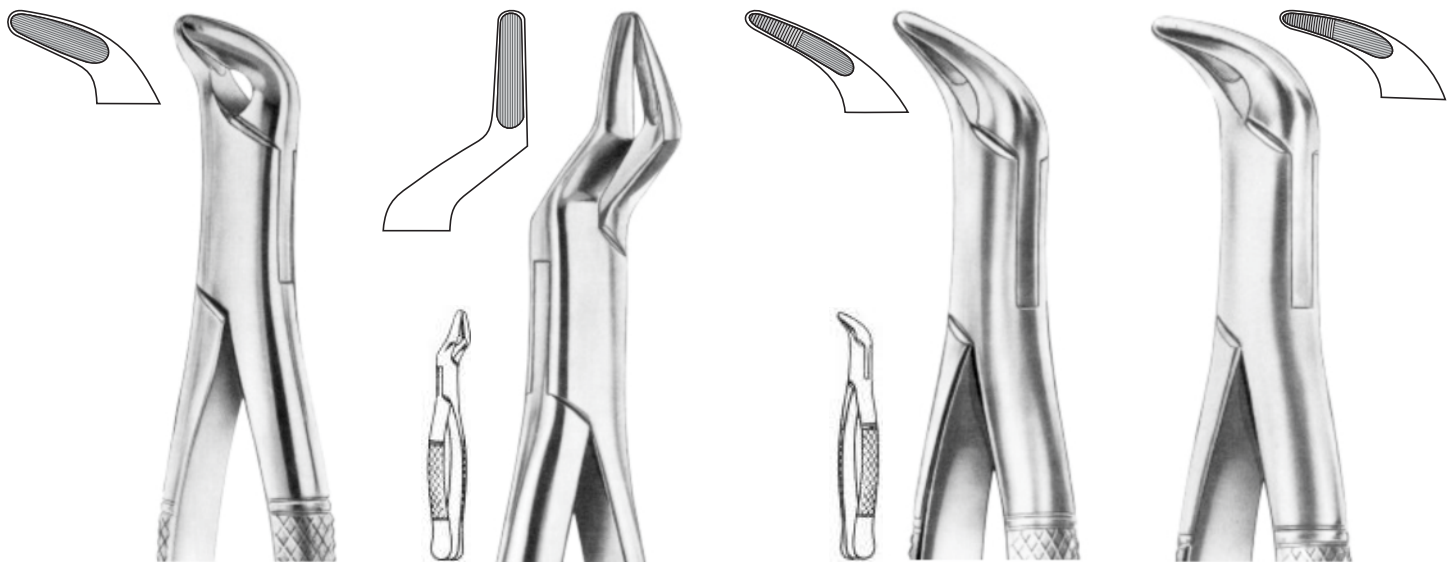


No. 29S  
 FI-01-135  
 Lower teeth children

No. 30S  
 FI-01-136  
 Upper teeth children

No. 32  
 FI-01-137  
 Upper Bicuspids

32A  
 FI-01-138  
 Upper Bicuspids & Roots

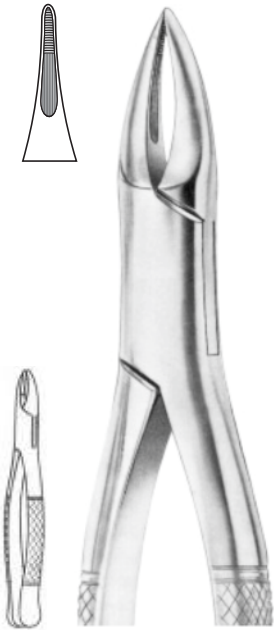


No. 34  
 FI-01-139  
 Lower Anteriors & Roots

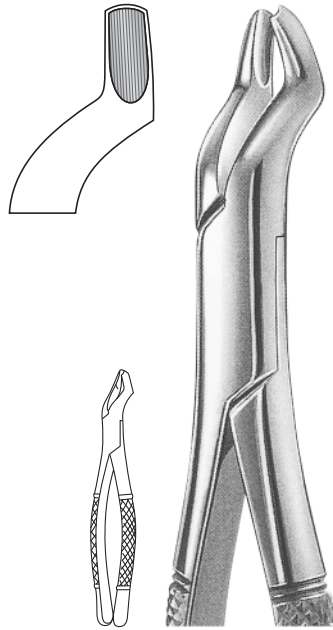
No. 35  
 FI-01-140  
 Upper Roots

No. 36  
 FI-01-141  
 Lower Anteriors & Roots

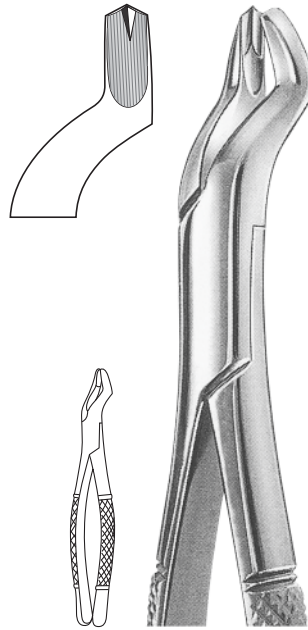
No. 37  
 FI-01-142  
 Lower Anteriors & Roots



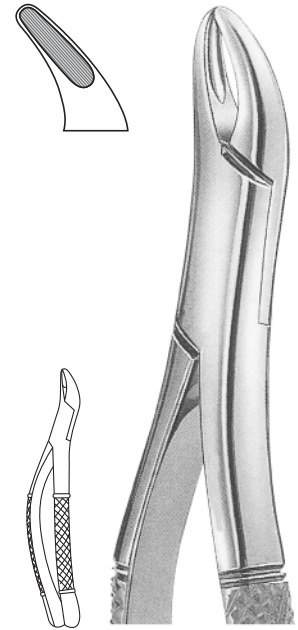
No. 38  
**FI-01-143**  
Upper Anteriors & Roots



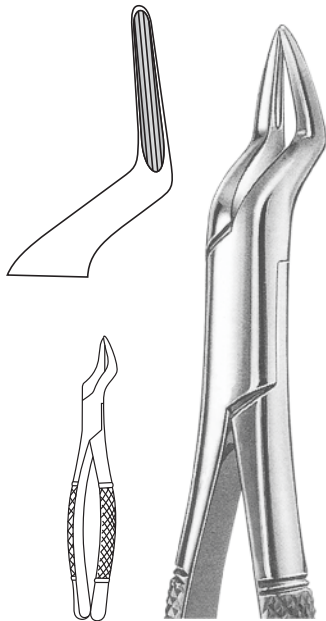
53L  
**FI-01-144**  
Gold Plated  
Upper Molars, left



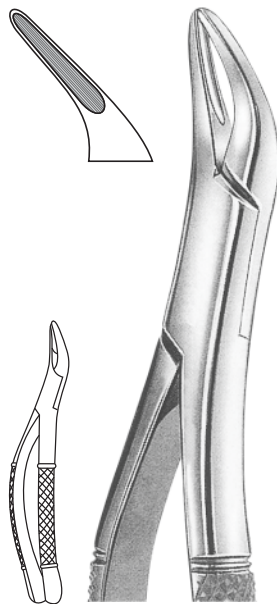
53R  
**FI-01-145**  
Gold Plated  
Upper Molars, right



No. 62  
**FI-01-146**  
Upper & Lower Incisors



No. 65  
**FI-01-147**  
Gold Plated  
Upper Incisors, Roots & Fragments



No. 69  
**FI-01-148**  
Gold Plated  
Upper & Lower Fragments & Roots

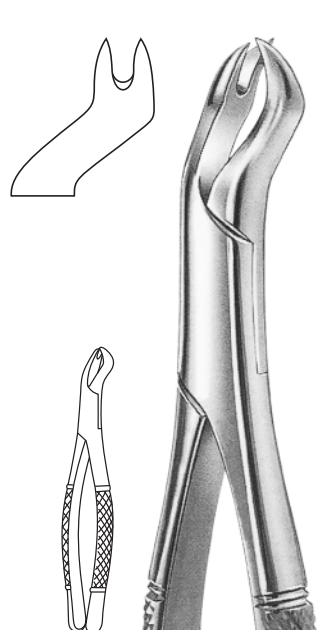


No. 85  
**FI-01-149**  
lower canines,  
premolars and molars

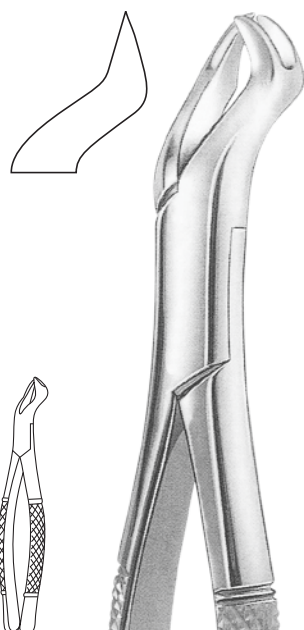


No. 85A  
**FI-01-150**  
lower canines,  
premolars and molars

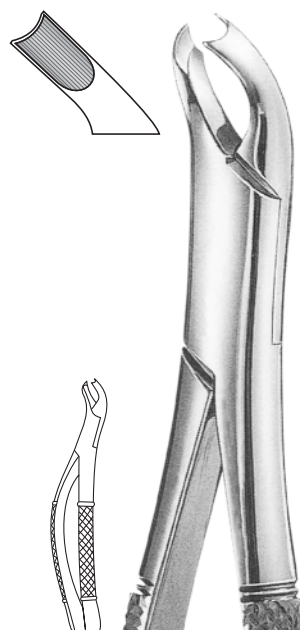
EXTRACTION FORCEPS "AMERICAN PATTERN"  
 PINZA PER ESTRAZIONE "MODELLO AMERICANO"



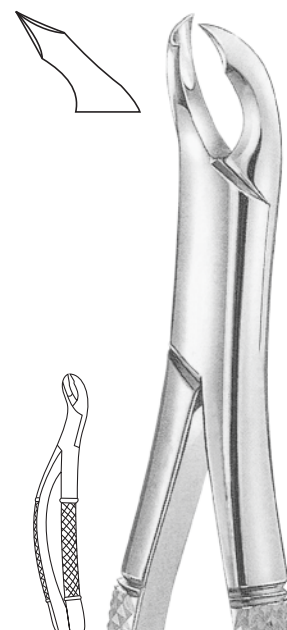
88L  
**FI-01-151**  
 Upper Molars, left



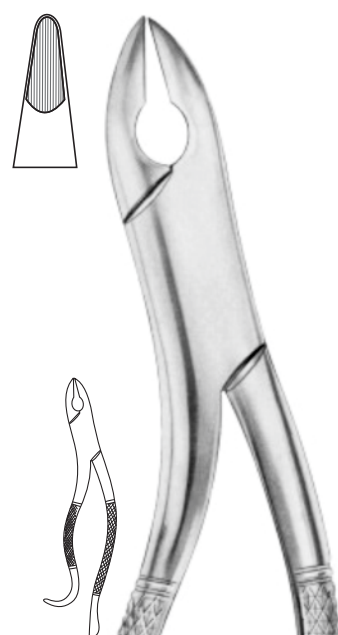
88R  
**FI-01-152**  
 Upper Molars, right



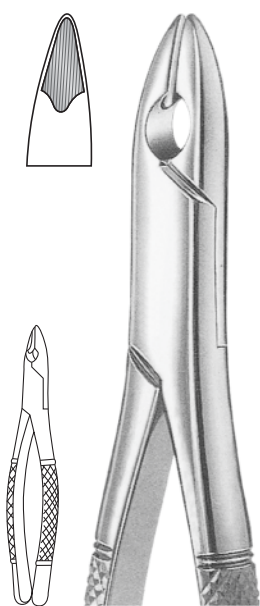
No. 89  
**FI-01-153**  
 Upper Molars, right



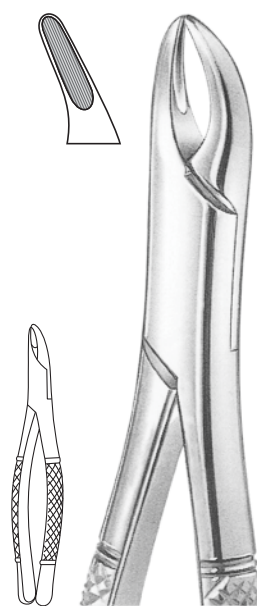
No. 90  
**FI-01-154**  
 Upper Molars, left



Kells  
 99A **FI-01-155**  
 Upper Incisors, Canines, Premolars



Kells  
 99C **FI-01-156**  
 Upper Incisors & Bicuspid



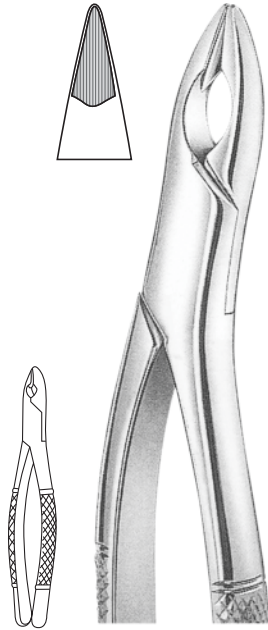
Hull  
 No. 101 **FI-01-157**  
 Universal for Bicuspid & Deciduous



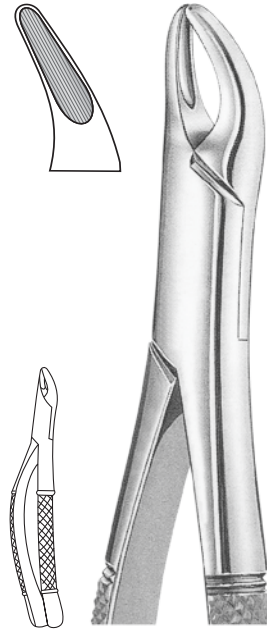
No. 103 **FI-01-158**  
 lower incisors, premolars



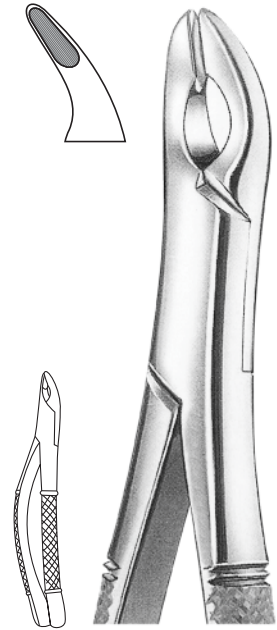
No. 104  
**FI-01-159**  
Upper third molars



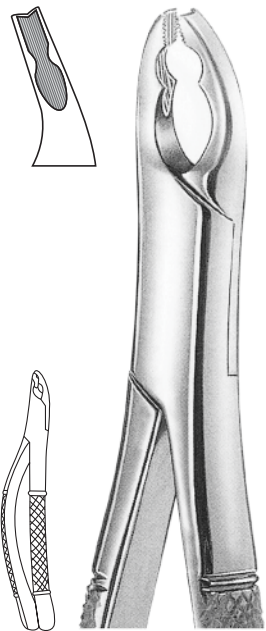
Nevius  
No. 110S **FI-01-160**  
Upper Bicuspids & Cuspids



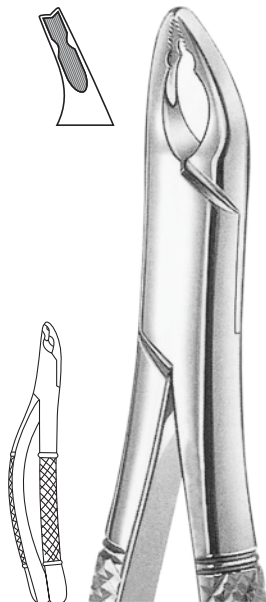
No. 150  
**FI-01-161**  
Upper Incisors, Bicuspids & Roots



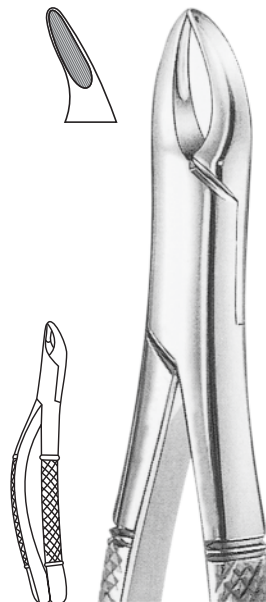
Cryer  
150A **FI-01-162**  
Upper Incisors, Cuspids & Bicuspids



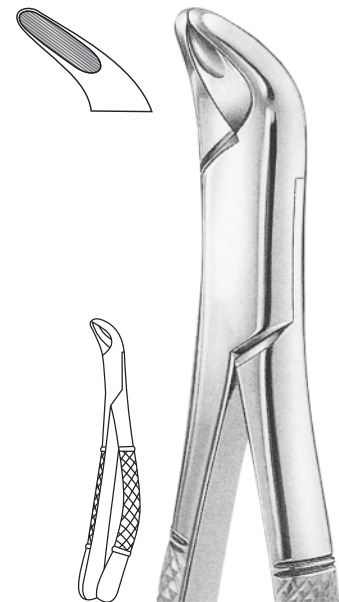
Cryer  
150 AS **FI-01-163**  
Upper Incisors, Cuspids  
serrated jaw



Cryer  
No. 150 XAS **FI-01-164**  
Children, Upper Incisors &  
Cuspids, serrated jaw

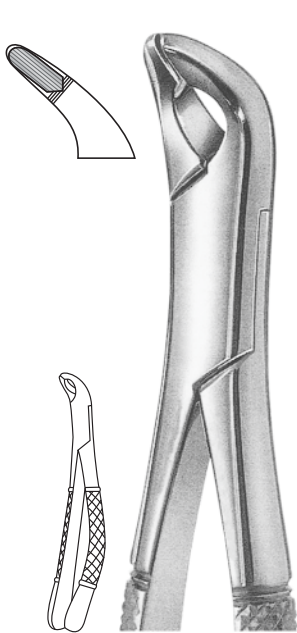


Cryer  
No. 150 S  
**FI-01-165**  
Children, Upper Incisors, Bicuspids & Roots

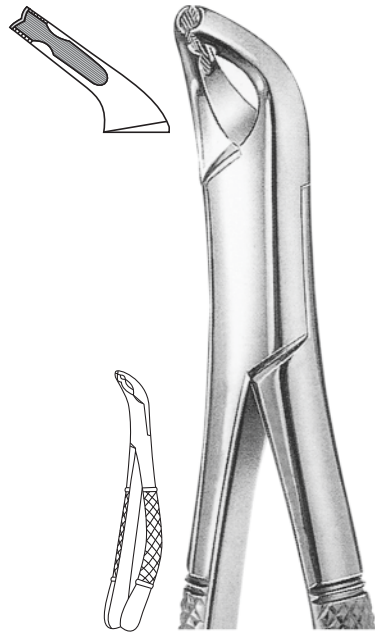


Cryer  
No. 151  
**FI-01-166**  
Lower Incisors, Bicuspids & Roots

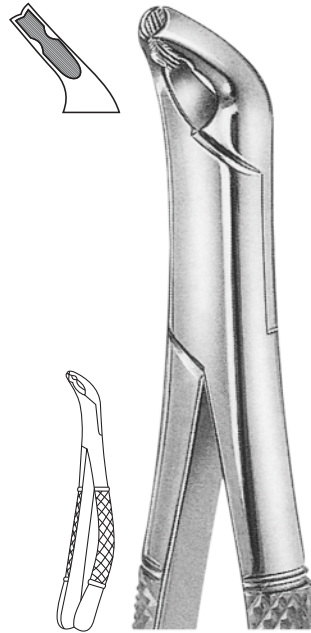
EXTRACTION FORCEPS "AMERICAN PATTERN"  
 PINZA PER ESTRAZIONE "MODELLO AMERICANO"



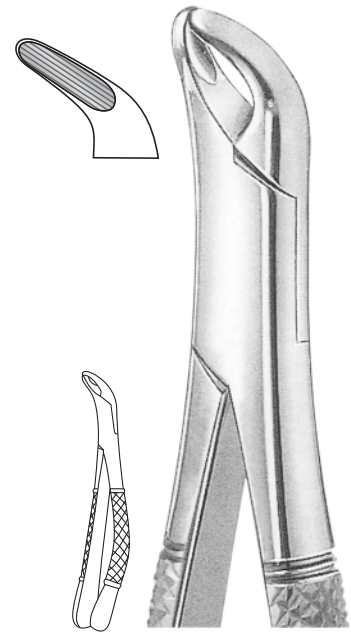
Cryer  
 151 A  
**FI-01-167**  
 Lower Incisors, Cuspids  
 & Bicuspids



Cryer  
 151 AS  
**FI-01-168**  
 Lower Incisors & Cuspids, serrated jaw



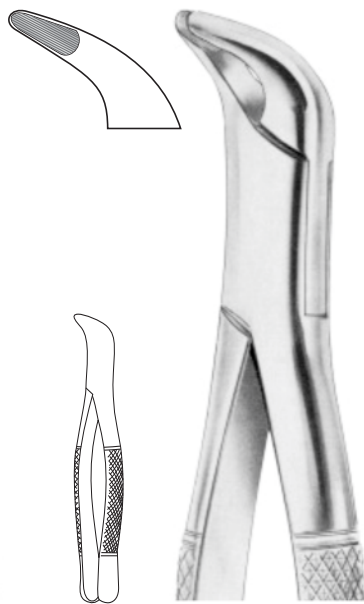
No. 151 XAS  
**FI-01-169**  
 Children, Lower Incisors &  
 Cuspids, serrated jaw



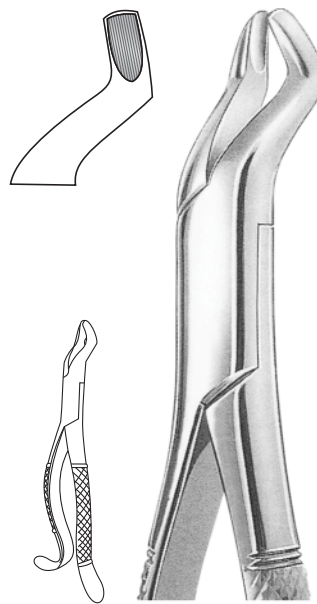
Cryer  
 No. 151S  
**FI-01-170**  
 Children, Lower incisors, Bicuspids & Roots



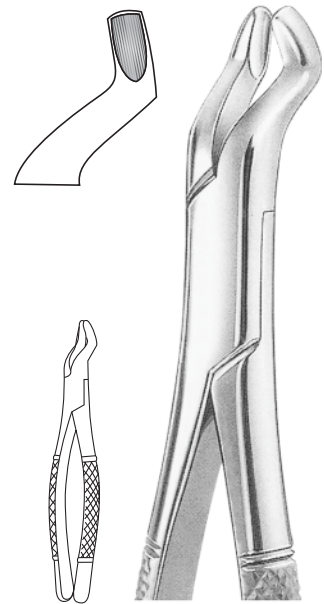
No. 201  
**FI-01-171**  
 Upper Incisors, Canines, premolars



No. 203  
**FI-01-172**  
 Lower Incisors & Roots



No. 210 H  
**FI-01-173**  
 Upper Wisdoms, Hook Handle

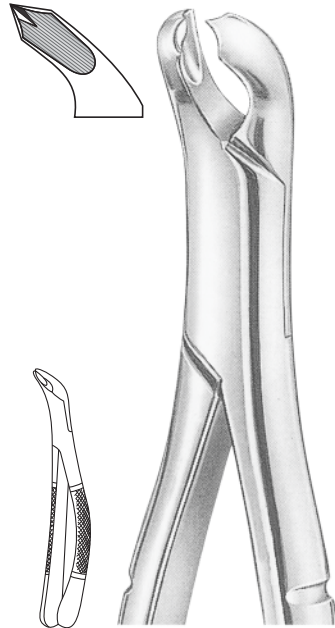


No. 210 S  
**FI-01-174**  
 Upper Wisdoms

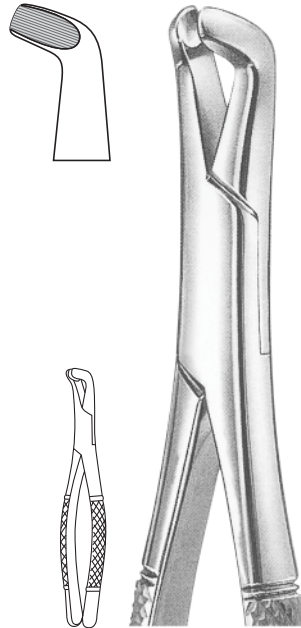




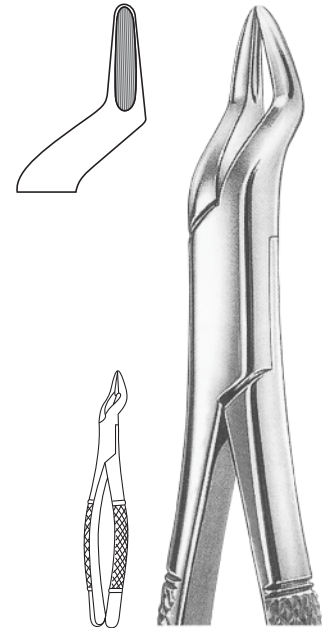
No. 213  
**FI-01-175**  
Upper Centrals & Canines



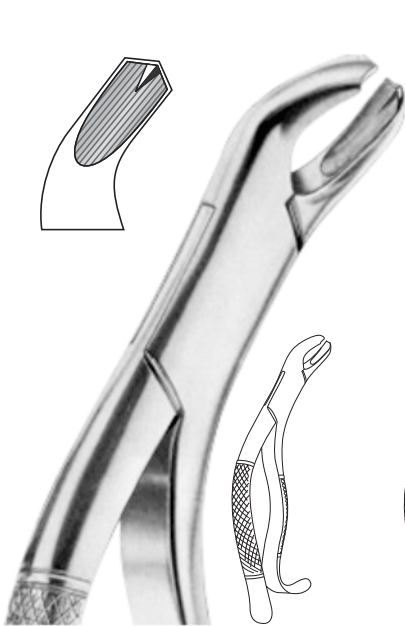
No. 217  
**FI-01-176**  
Lower Molars



No. 222  
**FI-01-177**  
Lower Wisdoms



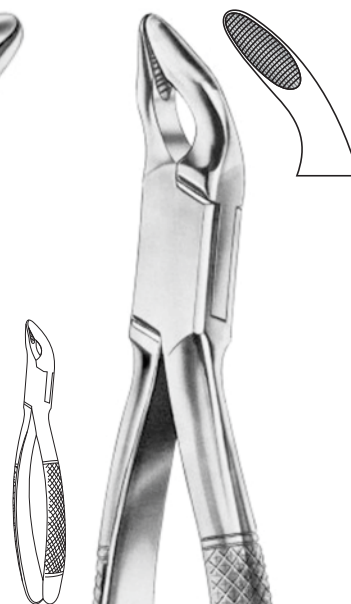
No. 286  
**FI-01-178**  
Upper Incisors, Bicusps & Roots



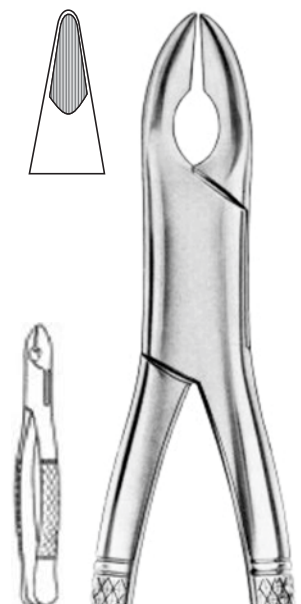
No. 286  
**FI-01-179**  
Swing lower molars



No. 288  
**FI-01-180**  
Lower Canines & Premolars

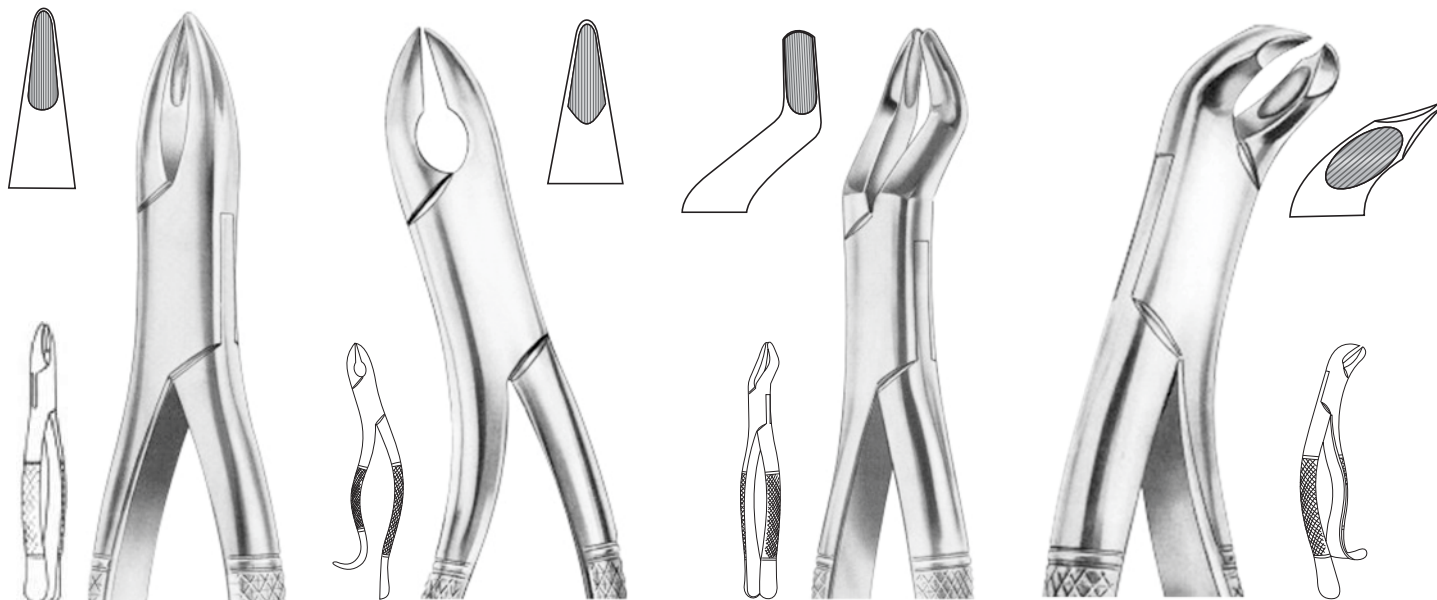


Cohen  
No. 310 **FI-01-181**  
Universal Forceps



Nevius  
No. 10S **FI-01-182**  
Upper Canines

EXTRACTION FORCEPS "AMERICAN PATTERN"  
 PINZA PER ESTRAZIONE "MODELLO AMERICANO"

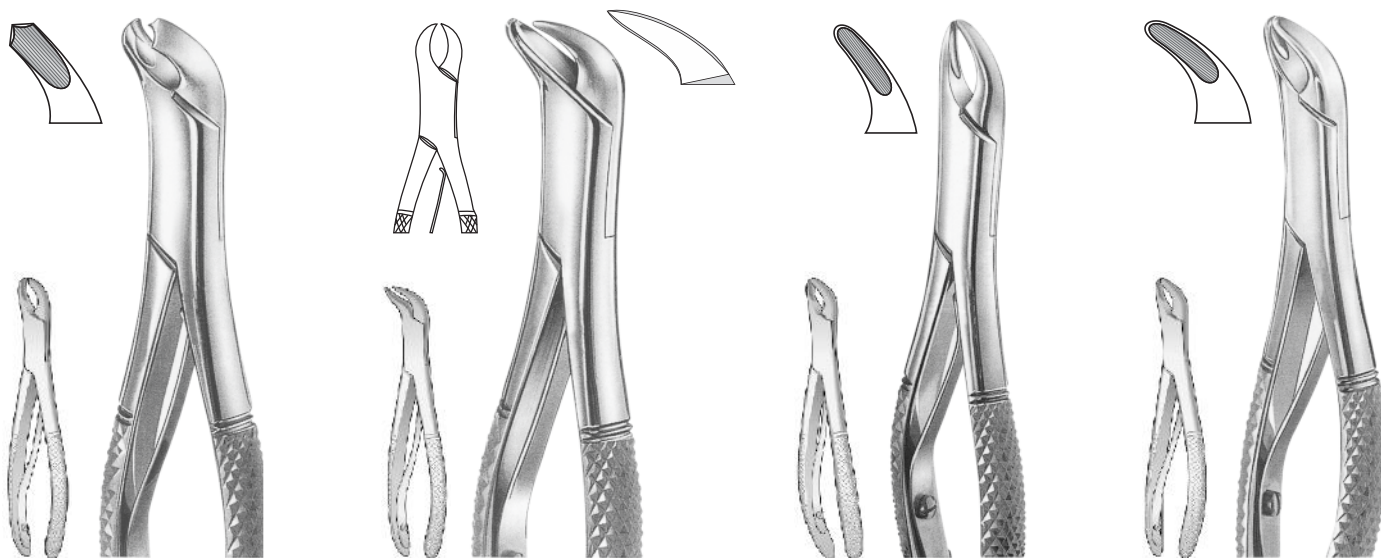


Henahan  
 No. 315A  
**FI-01-183**  
 Upper Incisors

Nevius  
 No. 325/10H  
**FI-01-184**  
 Upper Canines

Standard  
 No. 330  
**FI-01-185**  
 Upper Third Molars

Woodward  
 No. 335  
**FI-01-186**  
 Lower Molars



No. 17-K  
**FI-01-187**  
 children Lower Molars

No. 23-K  
**FI-01-188**  
 children Lower Molars

No. 150-K  
**FI-01-189**  
 Children, Upper Incisors,  
 Bicuspids & Roots

No. 151-K  
**FI-01-190**  
 Children, Lower Incisors,  
 Bicuspids & Roots



02

Page 21-35

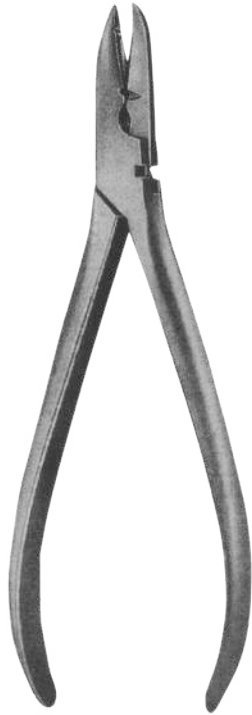
## Pliers

Pliers for Orthodontics & Prosthetics

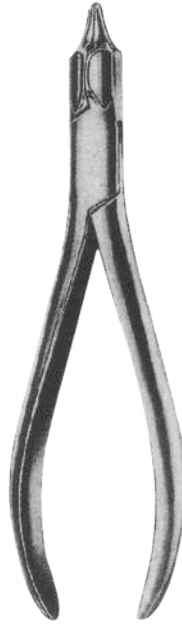
Carbide Inserted Pliers

Orthodontics Pliers Stand

Bone Rongeurs



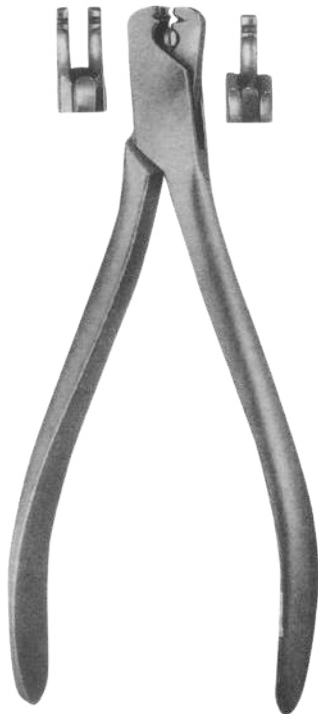
**FI-02-001**  
Waldsachs  
15 cm



**FI-02-002**  
Universal  
16 cm



**FI-02-003**  
Nance  
13.5 cm



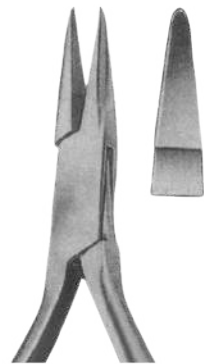
**FI-02-004**  
Aderer  
14.5 cm



**FI-02-005**  
Model Marburg  
Serrated Jaws  
14 cm



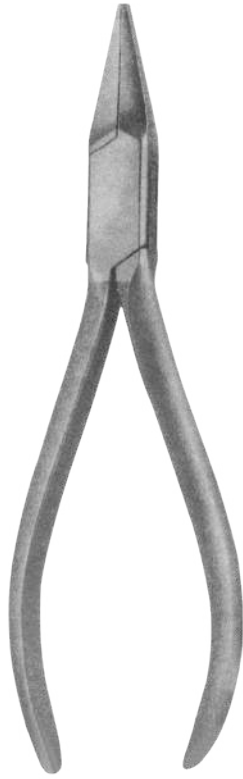
**FI-02-006**  
Model Marburg  
Smooth Jaws  
14 cm



**FI-02-007**  
Model Marburg  
Smooth Jaws  
14 cm



**FI-02-008**  
Goslee  
Serrated Jaws  
14 cm



**FI-02-009**  
Flat Pliers  
14 cm



**FI-02-010**  
14 cm



**FI-02-011**  
14 cm



**FI-02-012**  
14 cm



**FI-02-013**  
14 cm



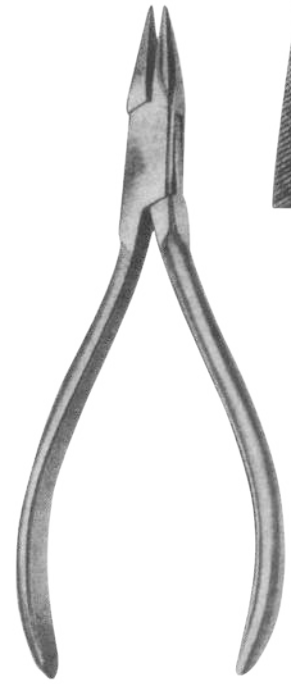
**FI-02-014**  
14 cm



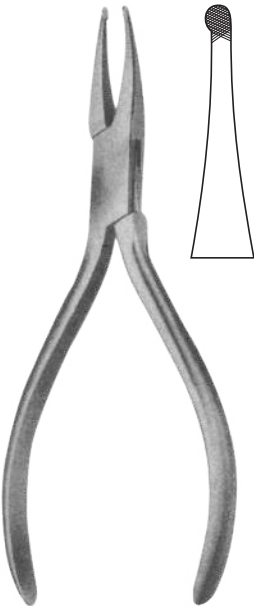
**FI-02-015**  
14 cm



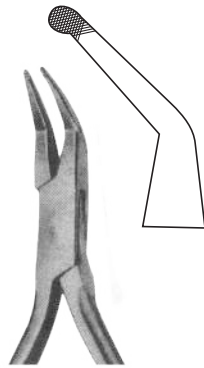
**FI-02-016**  
14 cm



**FI-02-017**  
Serrated Jaws  
12 cm



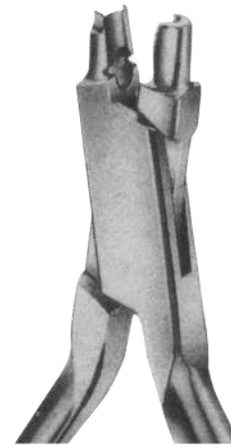
**FI-02-018**  
How  
14.5 cm



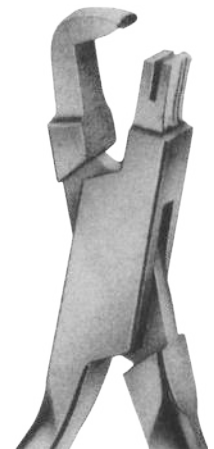
**FI-02-019**  
How  
14.5 cm



**FI-02-020**  
How  
14.5 cm



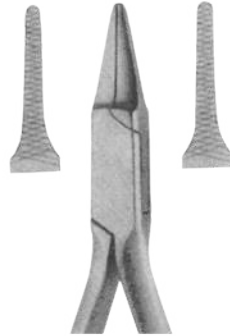
**FI-02-021**  
Arrow Clasp Forming  
12 cm



**FI-02-022**  
Arrow Clasp Forming  
12 cm



**FI-02-023**  
Peeso  
13.5 cm



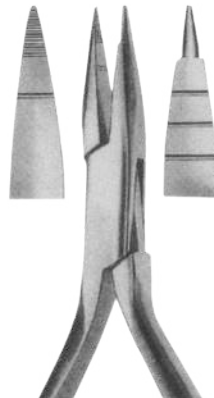
**FI-02-024**  
Peeso  
13.5 cm



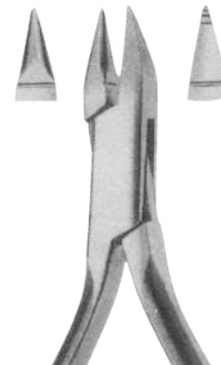
**FI-02-025**  
Langenbeck  
14 cm



**FI-02-026**  
Langenbeck  
14 cm



**FI-02-027**  
Jarabak  
14 cm



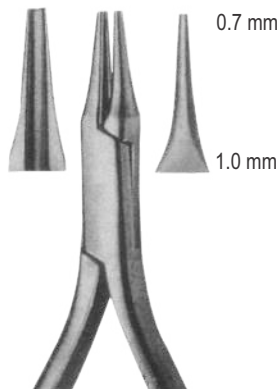
**FI-02-028**  
Bending Plier  
13 cm



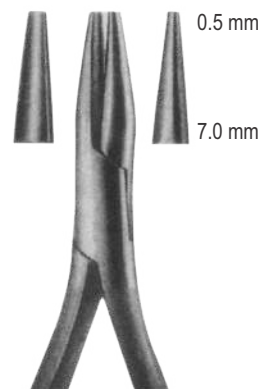
**FI-02-029**  
Angle  
12.5 cm



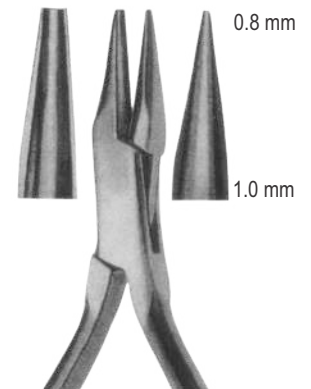
**FI-02-030**  
Andresen  
13 cm



**FI-02-031**  
Bending Plier  
13.5 cm



**FI-02-032**  
Schwarz  
13.5 cm



**FI-02-033**  
Fischer  
13 cm



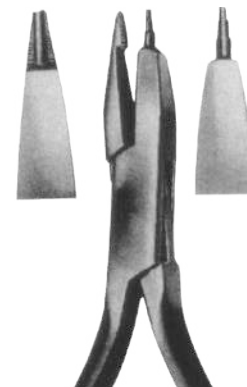
**FI-02-034**  
Aderer  
12 cm



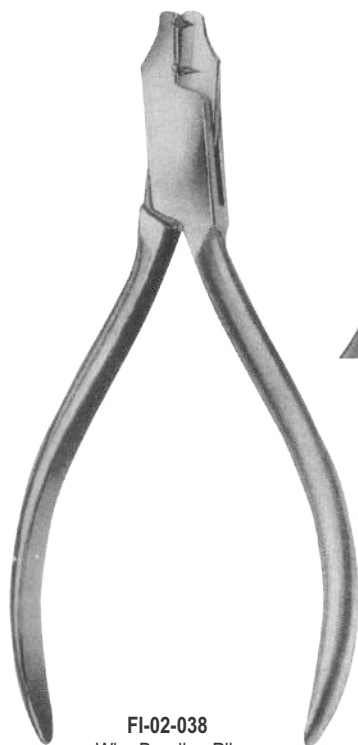
**FI-02-035**  
Aderer-Heavy  
12 cm



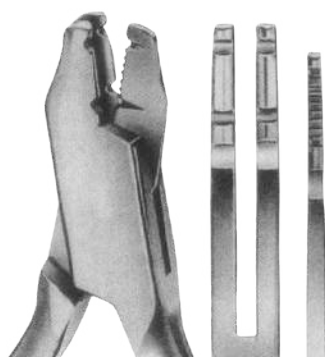
**FI-02-036**  
Tweed  
14.5 cm



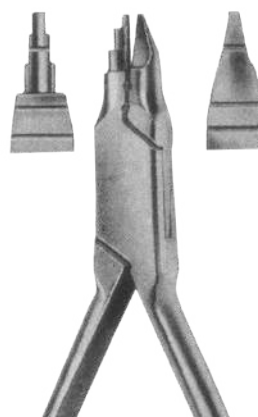
**FI-02-037**  
O'Brien  
13.5 cm



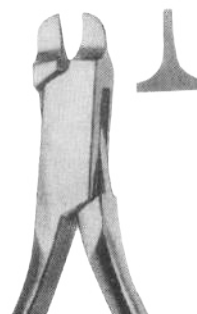
**FI-02-038**  
Wire Bending Pliers  
12.5 cm



**FI-02-039**  
Adams  
12.5 cm



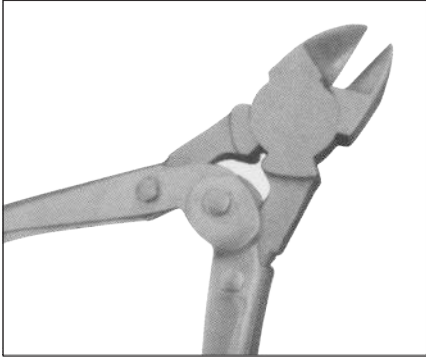
**FI-02-041**  
Young  
14 cm



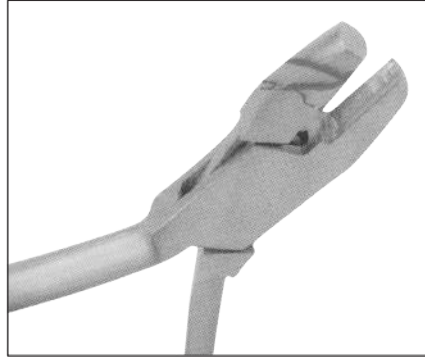
**FI-02-040**  
Frevert  
12.5 cm



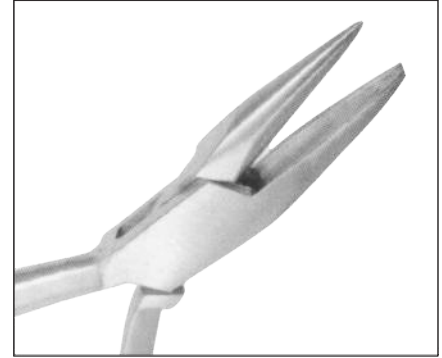
**FI-02-042**  
Clasp Ferring  
14 cm



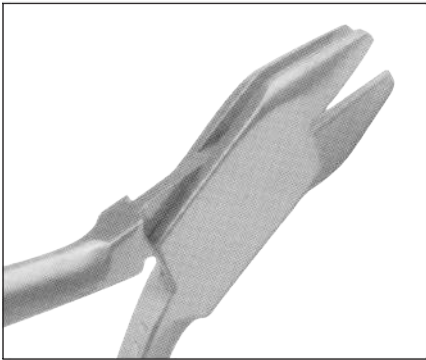
**FI-02-043**  
 Hard Wire Cutter  
 5 1/2" (14 cm)



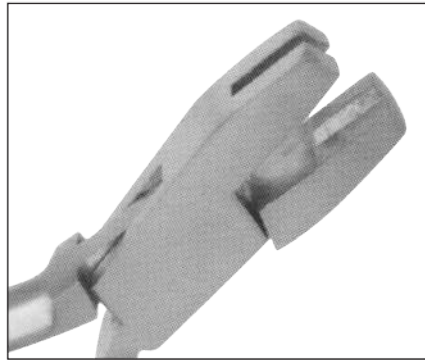
**FI-02-044**  
 Arch Forming Plier  
 5 1/2" (14 cm)



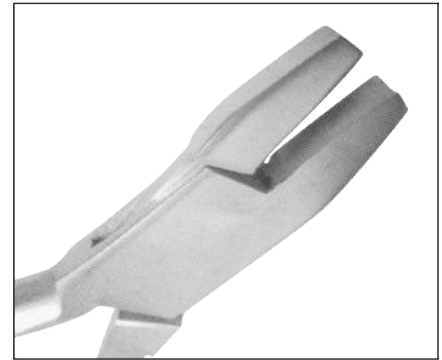
**FI-02-045**  
 Medium Size Bending Plier  
 5 1/2" (14 cm)



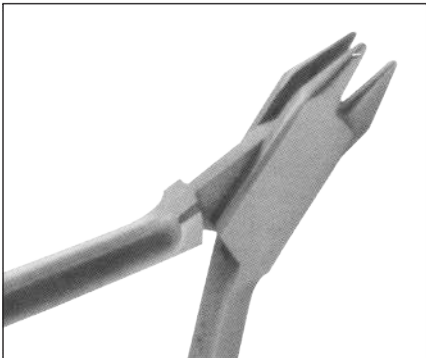
**FI-02-046**  
 Aderer Pliers  
 5 1/2" (14 cm)



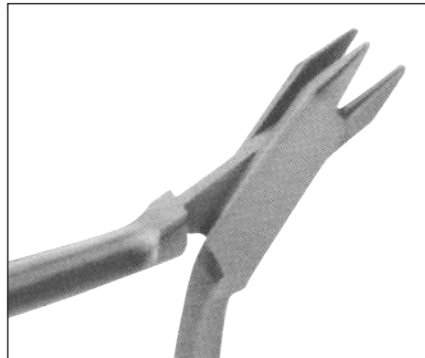
**FI-02-047**  
 Wire Bending Plier  
 5 1/2" (14 cm)



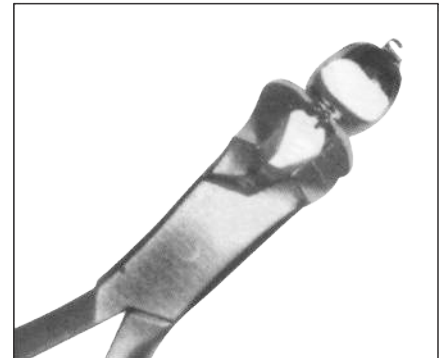
**FI-02-048**  
 Round & Concave Pliers  
 5 1/2" (14 cm)



**FI-02-049**  
 Aderer Pliers  
 with Narrow Standing Points,  
 for Bending Wires up to  $\varnothing$  0.5 mm,  
 Disinfectable, Sterilizable  
 4 3/4" (12 cm)

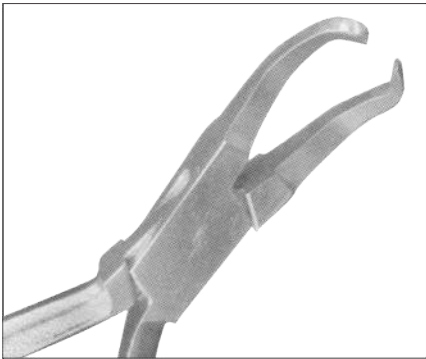


**FI-02-050**  
 Aderer Pliers  
 for Bending Wires up to  $\varnothing$  0.9 mm,  
 Disinfectable, Sterilizable  
 4 3/4" (12 cm)

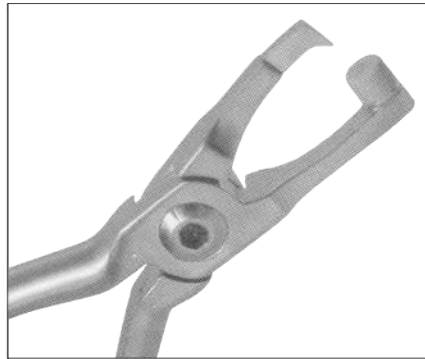


**FI-02-051**  
 Aderer Pliers  
 Bending Plier for Lingual Cleat  
 5 1/2" (14 cm)

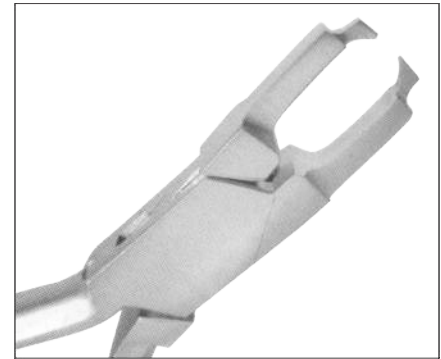




**FI-02-052**  
Bracket Removing Pliers  
5 1/2" (14 cm)



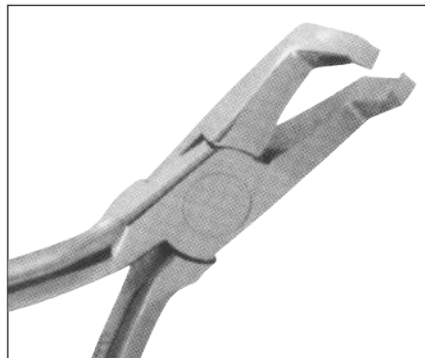
**FI-02-053**  
Bracket Removing Pliers  
5 1/2" (14 cm)



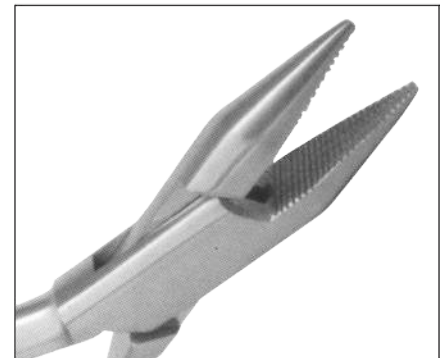
**FI-02-054**  
Bracket Removing Pliers  
5 1/2" (14 cm)



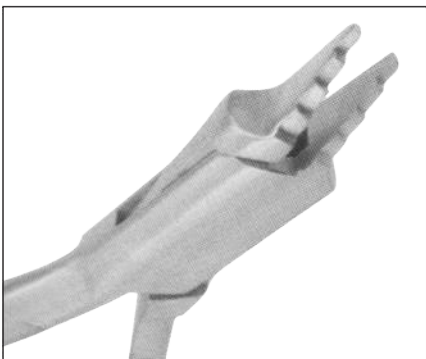
**FI-02-055**  
Bracket Removing Pliers  
5 1/2" (14 cm)



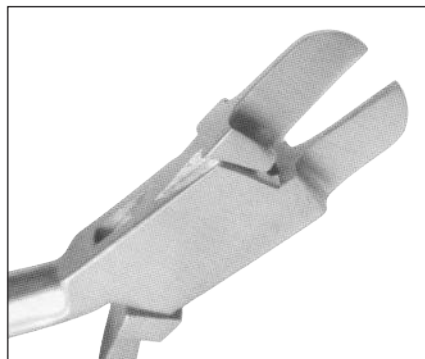
**FI-02-056**  
Bracket Removing Pliers  
5 1/2" (14 cm)



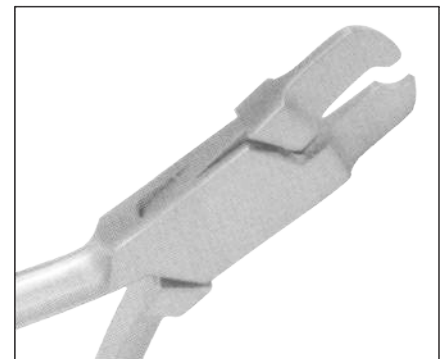
**FI-02-057**  
Flat Pliers  
5 1/2" (14 cm)



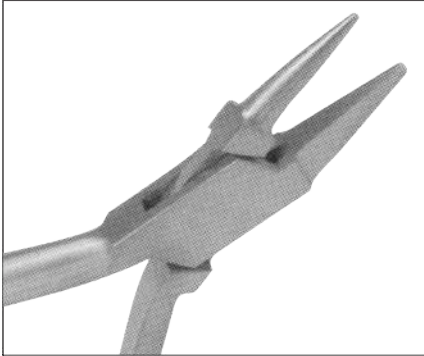
**FI-02-058**  
Nance Closing Loop Pliers  
5 1/2" (14 cm)



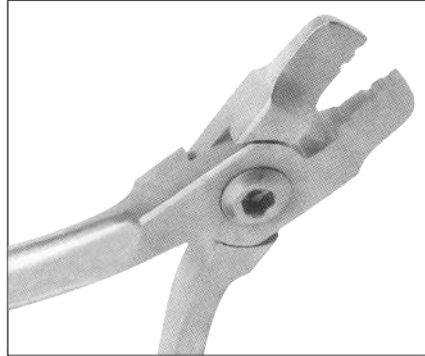
**FI-02-059**  
Angle Banding Pliers  
5 1/2" (14 cm)



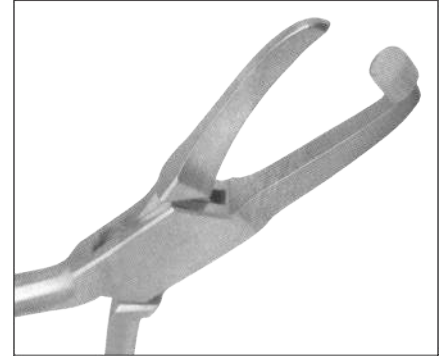
**FI-02-060**  
Crown Crimping Pliers  
5 1/2" (14 cm)



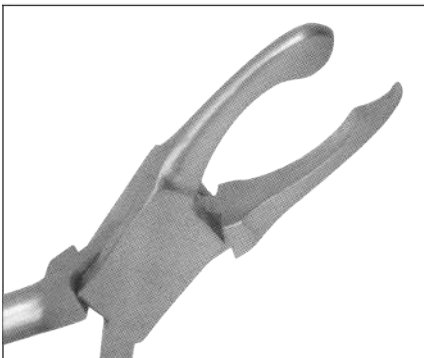
**FI-02-061**  
 Round & Flat Plier  
 5 1/2" (14 cm)



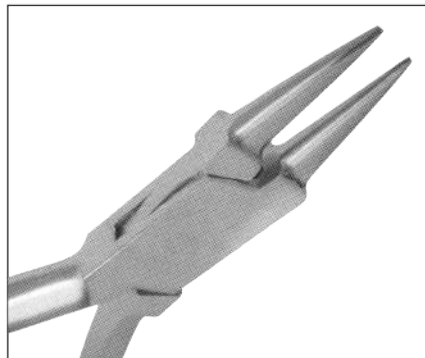
**FI-02-062**  
 Tweed Angle Arch Bending  
 5 1/2" (14 cm)



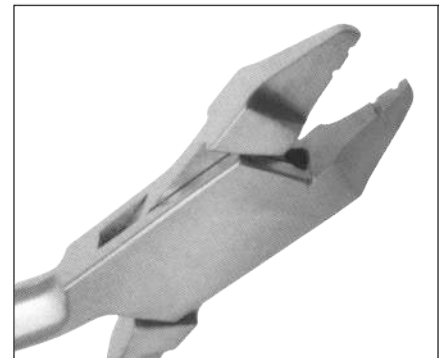
**FI-02-063**  
 Bend Removing Pliers  
 5 1/2" (14 cm)



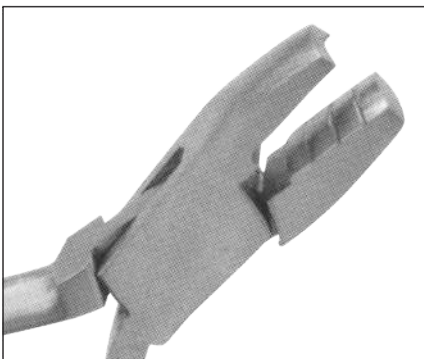
**FI-02-064**  
 Johnson Contouring Pliers  
 5 1/2" (14 cm)



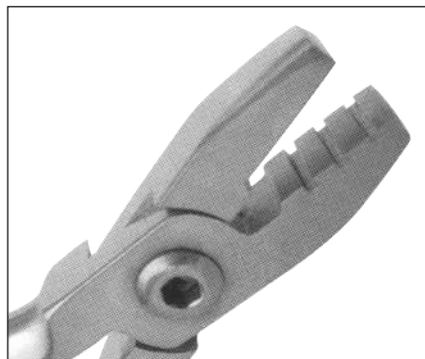
**FI-02-065**  
 Round Nose Pliers  
 5 1/2" (14 cm)



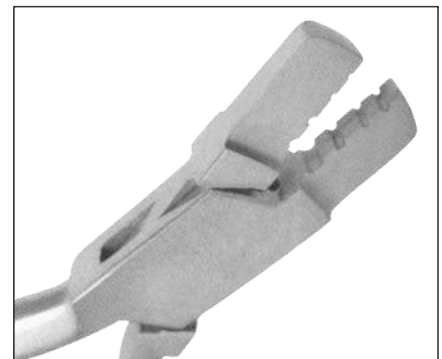
**FI-02-066**  
 Tweed Angle Arch Bending  
 5 1/2" (14 cm)



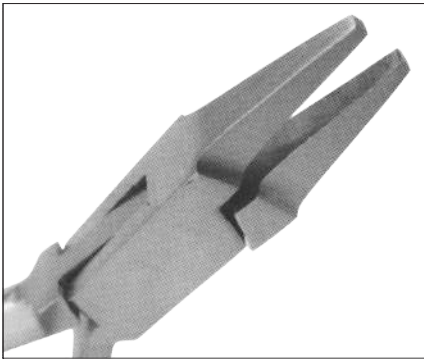
**FI-02-067**  
 De La Rosa Pliers  
 5 1/2" (14 cm)



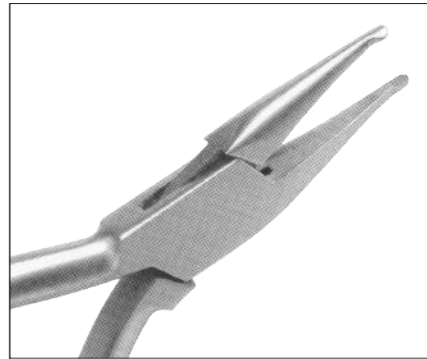
**FI-02-068**  
 Arch Forming Pliers  
 5 1/2" (14 cm)



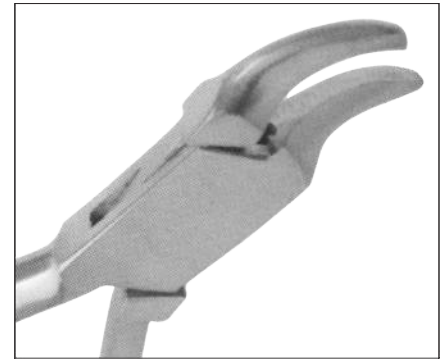
**FI-02-069**  
 Tweed Angle Arch Bending  
 5 1/2" (14 cm)



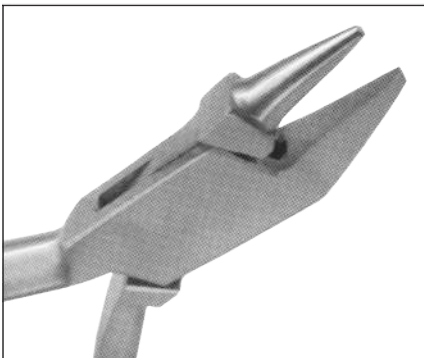
**FI-02-070**  
Flat Nose Pliers  
5 1/2" (14 cm)



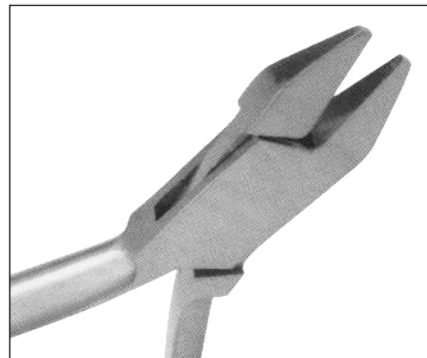
**FI-02-071**  
How Pliers  
5 1/2" (14 cm)



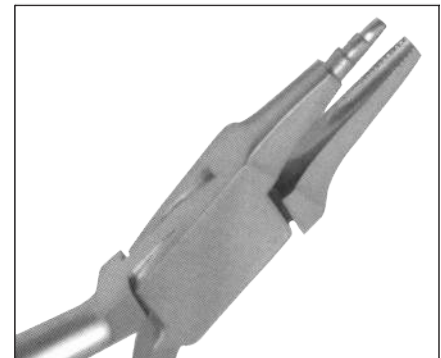
**FI-02-072**  
Gordon - Contouring  
5 1/2" (14 cm)



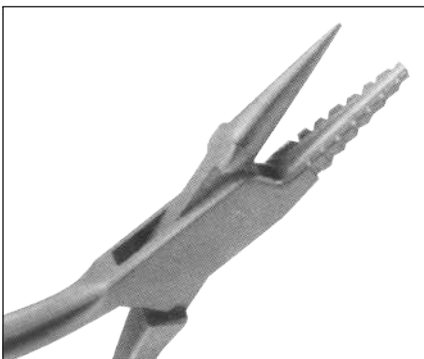
**FI-02-073**  
Adams Pliers  
5 1/2" (14 cm)



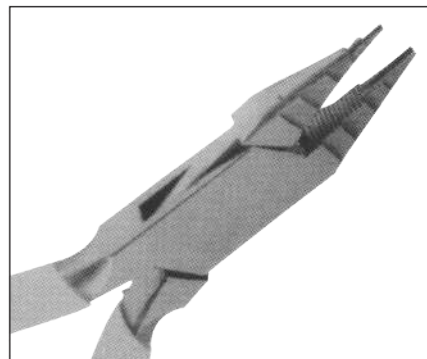
**FI-02-074**  
Adams Pliers  
5 1/2" (14 cm)



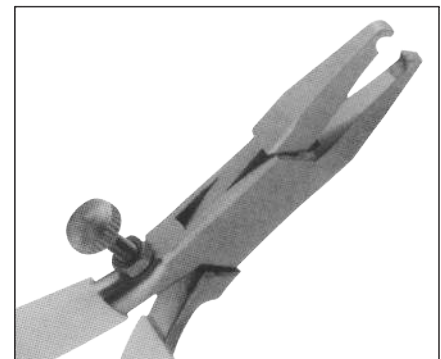
**FI-02-075**  
Tweed Pliers  
5 1/2" (14 cm)



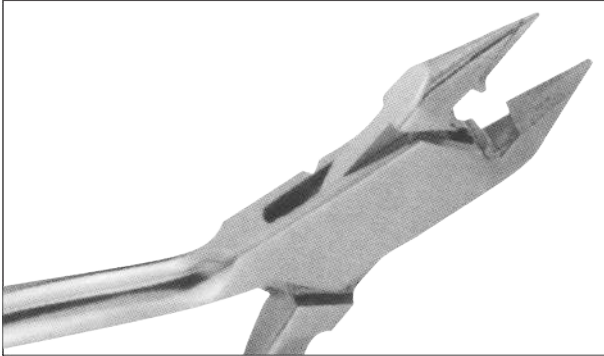
**FI-02-076**  
Bending Pliers  
Medium Fine, with Graduation  
for Wire up  $\varnothing$  1.0 mm  
5 1/2" (14 cm)



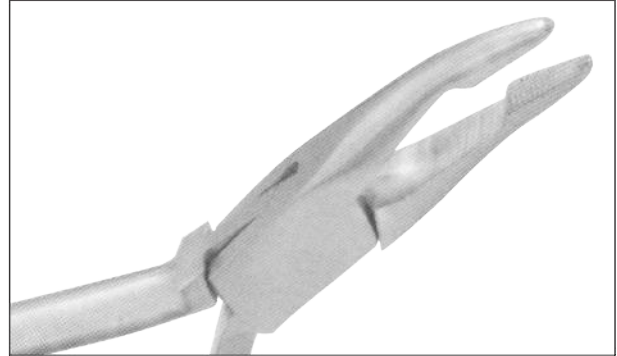
**FI-02-077**  
Special Pliers  
Max .022" x .028"  
5 1/2" (14 cm)



**FI-02-078**  
Pliers for Operating  
the Mobil-Stop  
5 1/2" (14 cm)



**FI-02-079**  
 Light Wire Plier for Wires  
 up to  $\varnothing$  0.60 mm  
 with Cutter Begg  
 4 3/4" (12 cm)



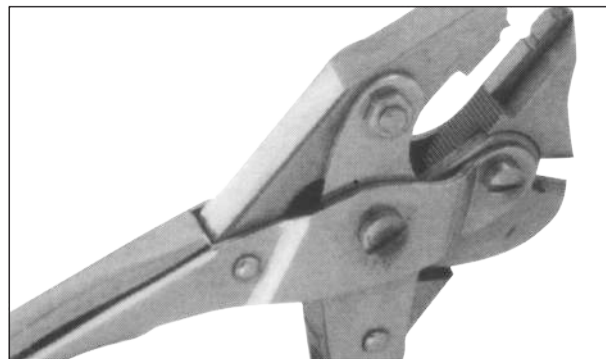
**FI-02-080**  
 Weingart Universal Pliers  
 5 1/2" (14 cm)



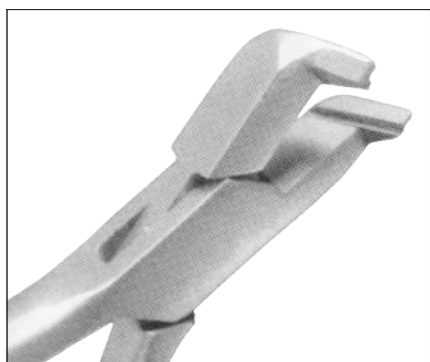
**FI-02-081**  
 Weingart Ultra Lightwire Pliers  
 5 1/2" (14 cm)



**FI-02-082**  
 Weingart Universal Lightwire Pliers  
 5 1/2" (14 cm)



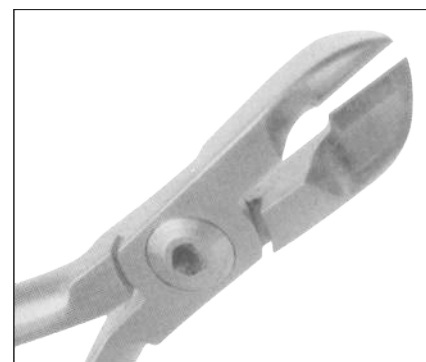
**FI-02-083**  
 Universal Facebow Pliers  
 6 1/2" (16.5 cm)



**FI-02-084**  
Distal Cutter Light Weight  
5 1/2" (14 cm)



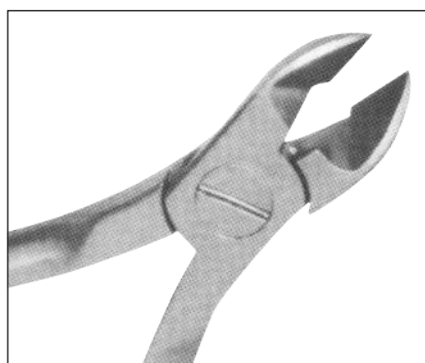
**FI-02-085**  
Distal Cutter Medium  
5 1/2" (14 cm)



**FI-02-086**  
Ligature Pin Cutter  
5 1/2" (14 cm)



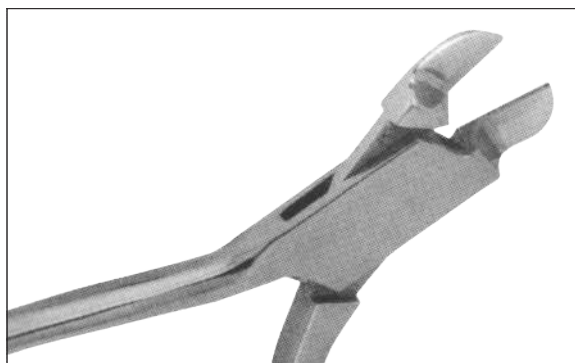
**FI-02-087**  
Hard Wire Cutter  
5 1/2" (14 cm)



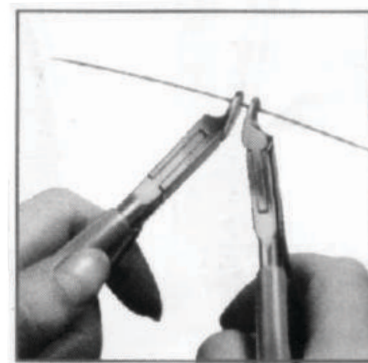
**FI-02-088**  
Hard Wire Cutter  
5 1/2" (14 cm)



**FI-02-089**  
Bracket Removing Pliers  
5 1/2" (14 cm)



**FI-02-090**  
Arch Torquing and Bending Pliers  
for Wires up to  $\varnothing$ 0.60 mm  
Allow to User a Pair  
4 3/4" (12 cm)

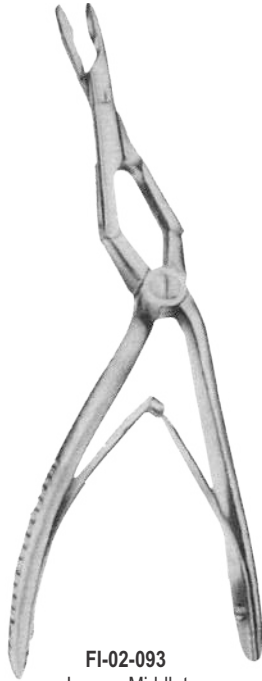




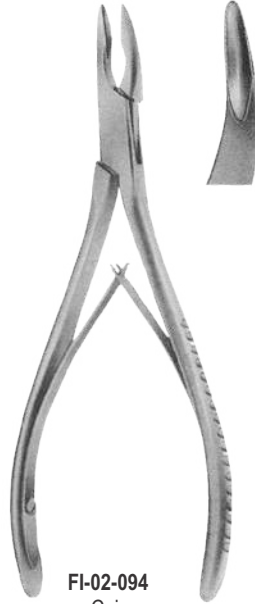
FI-02-091  
Pliers Stand



**FI-02-092**  
Bayer  
150 mm (6")  
5 mm Bite



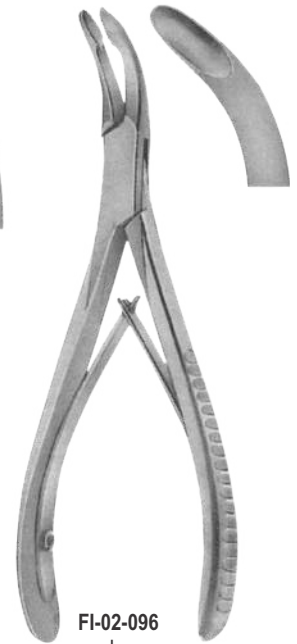
**FI-02-093**  
Jansen-Middleton  
Septum Forceps  
200 mm (8") Spoon Shaped  
4 mm Bite



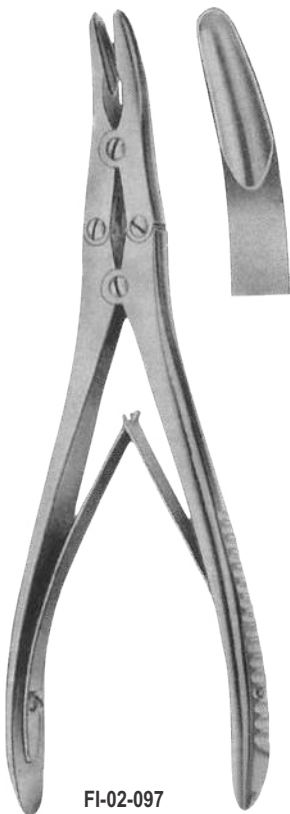
**FI-02-094**  
Cairns  
140 mm (5.1/2")  
4 mm Bite



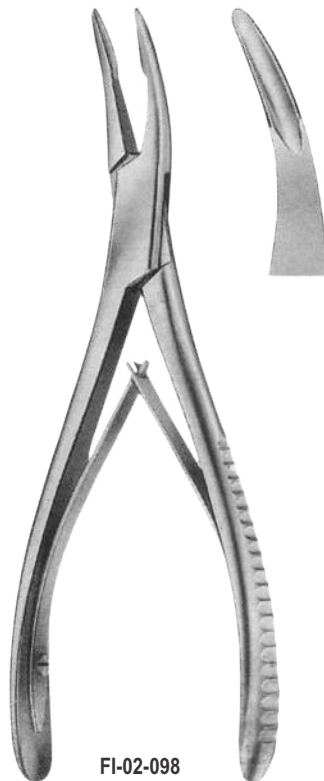
**FI-02-095**  
Cairns  
140 mm (5.1/2")  
4 mm Bite



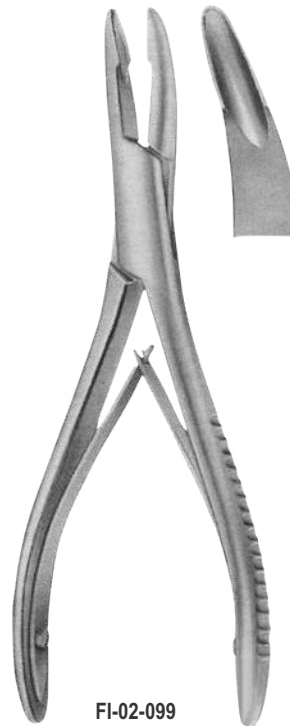
**FI-02-096**  
Luer  
155 mm (6")



**FI-02-097**  
Ruskin  
190 mm (7.1/2")  
6 mm Bite



**FI-02-098**  
Hartmann  
180 mm (7")



**FI-02-099**  
Mead  
165 mm (6.1/2")



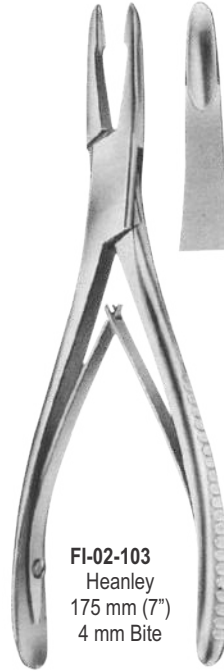
**FI-02-100**  
Jansen  
150 mm (6")



**FI-02-101**  
 Trotter  
 200 mm (8")  
 10 mm Bite



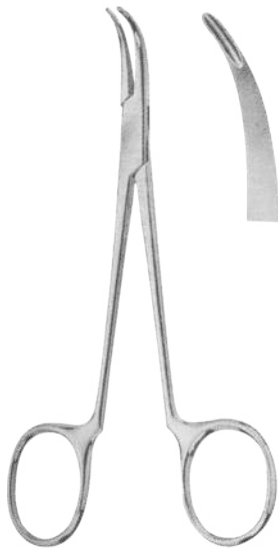
**FI-02-102**  
 Synovectomy  
 Rongeur  
 175 mm (7")



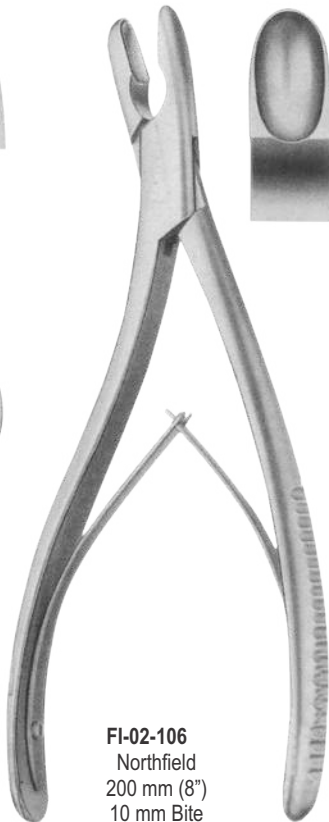
**FI-02-103**  
 Heanley  
 175 mm (7")  
 4 mm Bite



**FI-02-104**  
 Pennybacker  
 200 mm (8")  
 4 mm Bite



**FI-02-105**  
 Synovectomy Rongeur  
 130 mm (5.1/8")  
 Jaw Width 2 mm



**FI-02-106**  
 Northfield  
 200 mm (8")  
 10 mm Bite

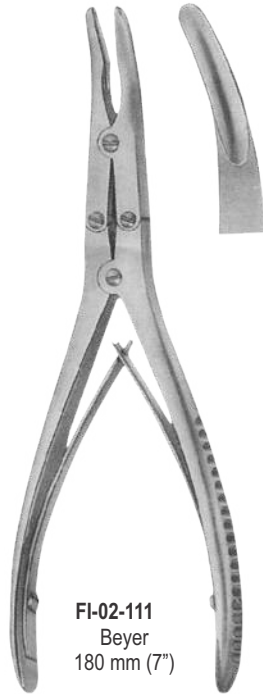
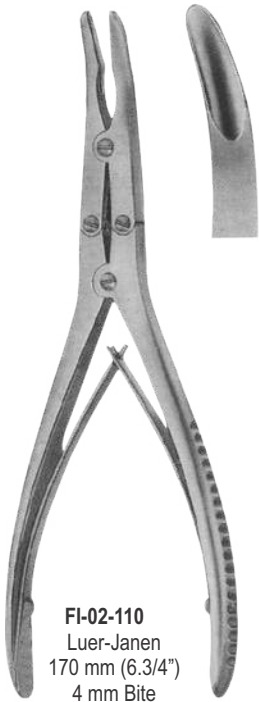


**FI-02-107**  
 Wilms  
 200 mm (8")  
 4 mm Bite



Leksell  
**FI-02-108**  
 240 mm (9.1/2")  
 6 mm Bite  
**FI-02-109**  
 240 mm (9.1/2")  
 8 mm Bite







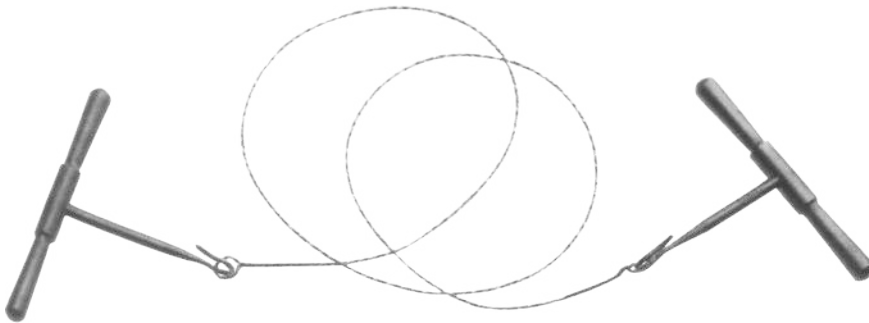
**FI-02-117**  
 Sargent (Van Havre)  
 220 mm (8.3/4")  
 10 mm Bite



**FI-02-118**  
 Olivecrona  
 230 mm (9")  
 6 mm Bite



**FI-02-119**  
 Stille-Ruskin  
 240 mm (9.1/2")



**FI-02-120**  
 Gigli Saw With Handle  
 500 mm (20")



**FI-02-121**  
 Rudor Edwards Costotome  
 230 mm (9")



03

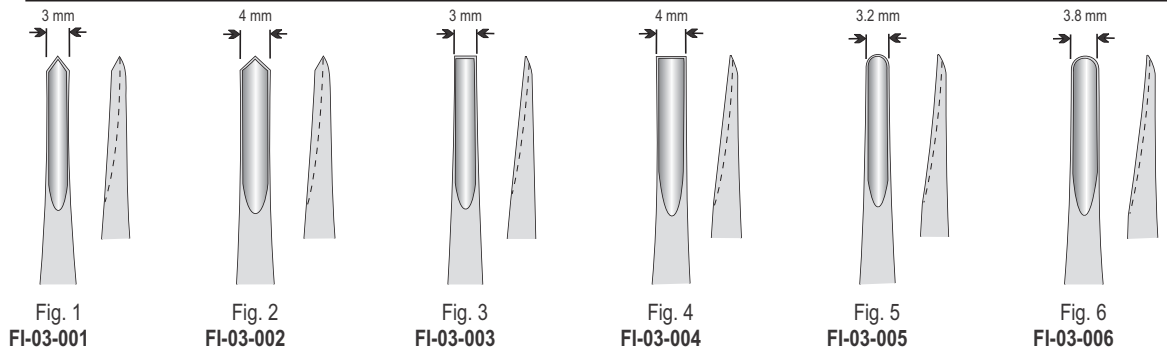
Page 36-42

## Elevators

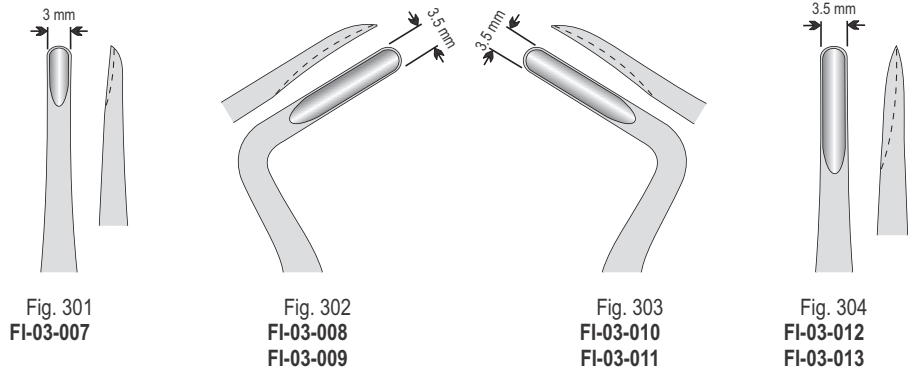
Root Elevators

Syndesmotomes

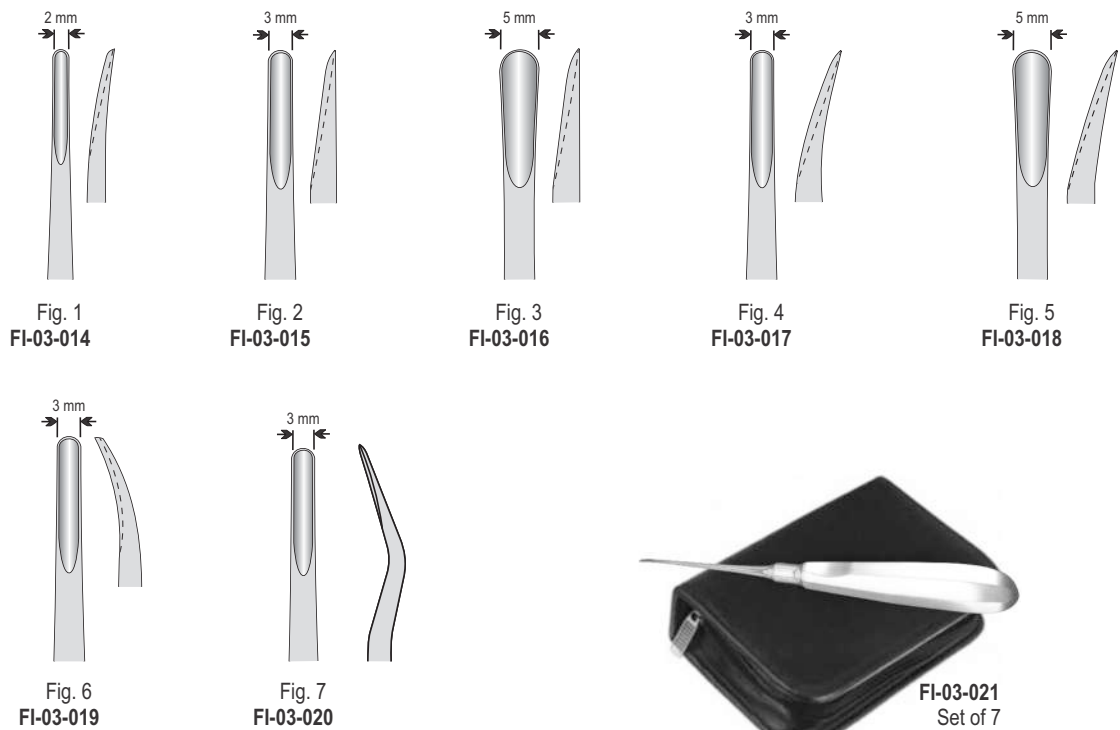
Bein



Apical



Luxators



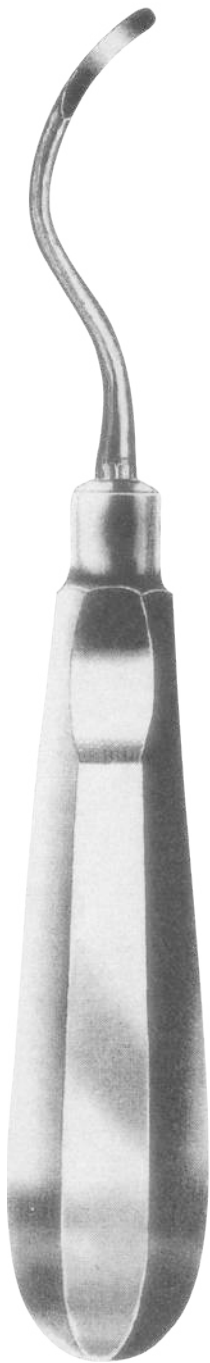


Fig . 10  
FI-03-029  
Miller-Apexo



11  
FI-03-022  
Miller-Apexo



12  
FI-03-023  
Miller-Apexo



13  
FI-03-024  
Miller-Apexo



14  
FI-03-025



15  
FI-03-026



22  
FI-03-027  
Curtis



23  
FI-03-028  
Curtis

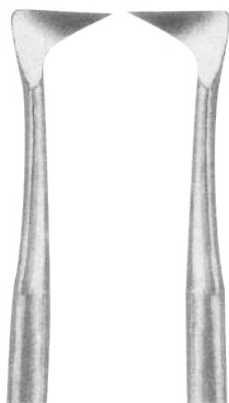


Fig . 10  
FI-03-030  
Seldin



Fig . 1R  
FI-03-031  
Seldin



Fig . 4L  
FI-03-032  
Seldin



Fig . 4R  
FI-03-033  
Seldin



Fig . 11  
FI-03-034  
Stout



Fig . 11A  
FI-03-035  
Stout



Fig . 44C  
FI-03-036  
Stout

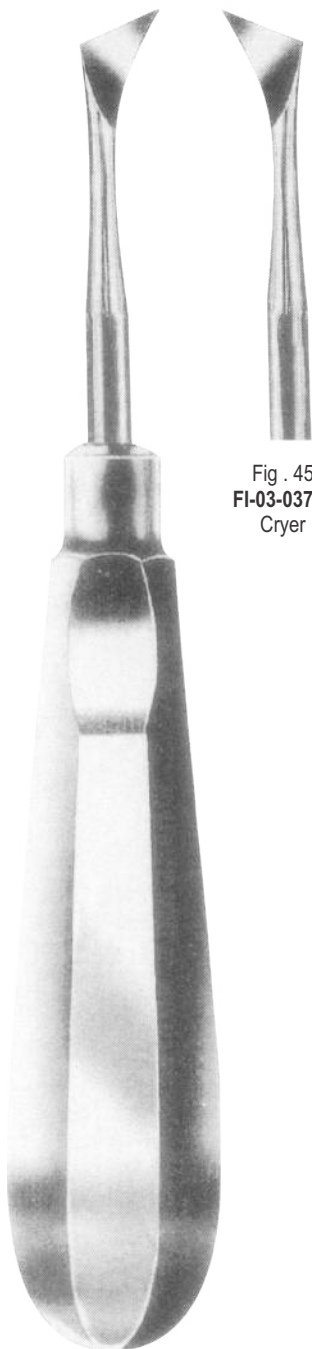


Fig . 44  
18-110-44  
Cryer



Fig . 45  
FI-03-037  
Cryer



Fig . 25  
MMI-03-038  
Cryer



Fig . 26  
MMI-03-039  
Cryer



Fig . 31  
MMI-03-040  
Cryer



Fig . 32  
MMI-03-041  
Cryer



Fig . 80  
MMI-03-042



Fig . 81  
MMI-03-043



Fig . 81A  
FI-03-045



Fig . 81E  
FI-03-046



Fig . 190  
FI-03-0467



Fig . 191  
FI-03-048



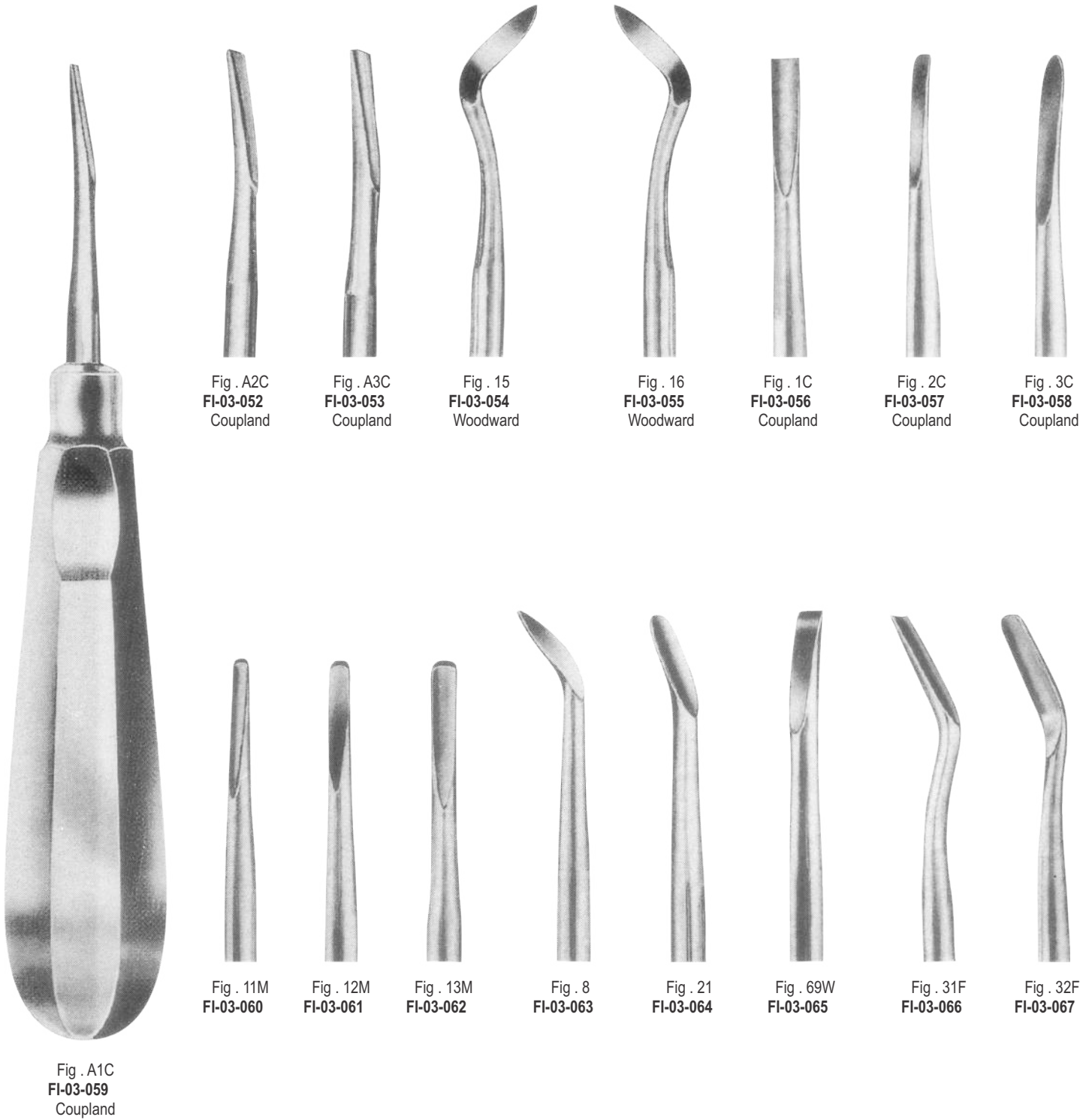
Fig . 23  
FI-03-049



Fig . 24  
FI-03-050



Fig . 98  
FI-03-051





Bein

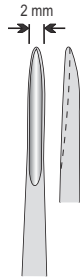


Fig. 1  
FI-03-068

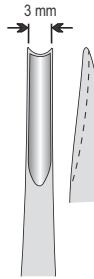


Fig. 2  
FI-03-069

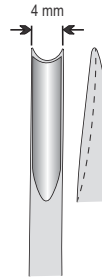


Fig. 3  
FI-03-070

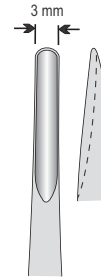


Fig. 4  
FI-03-071

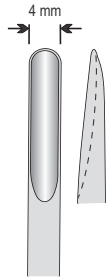


Fig. 5  
FI-03-072

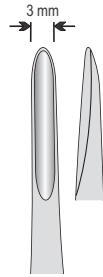


Fig. 6  
FI-03-073

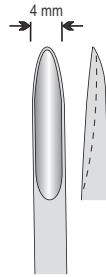


Fig. 7  
FI-03-074

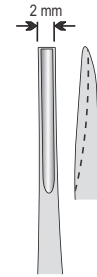


Fig. 8  
FI-03-075

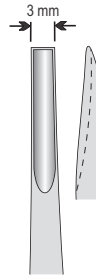


Fig. 9  
FI-03-076

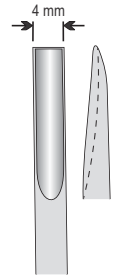


Fig. 10  
FI-03-077

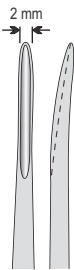


Fig. 1  
FI-03-078

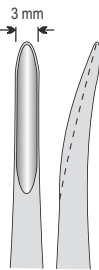


Fig. 2  
FI-03-079

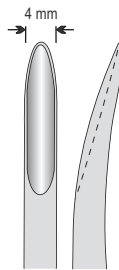


Fig. 3  
FI-03-080

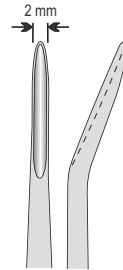


Fig. 1  
FI-03-081

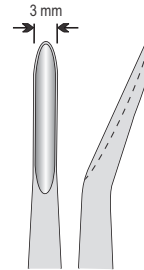


Fig. 2  
FI-03-082

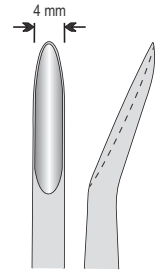


Fig. 3  
FI-03-083

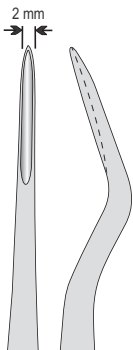


Fig. 1  
FI-03-084  
Bayonet Distal

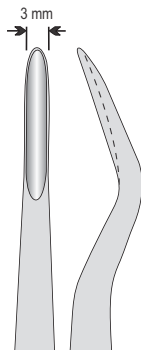


Fig. 2  
FI-03-085  
Bayonet Distal

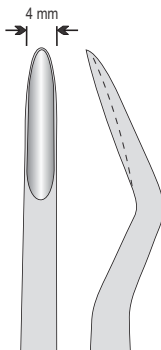


Fig. 3  
FI-03-086  
Bayonet Distal

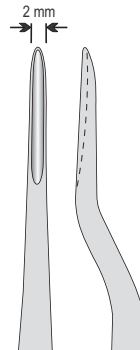


Fig. 1  
FI-03-087  
Bayonet Mesial

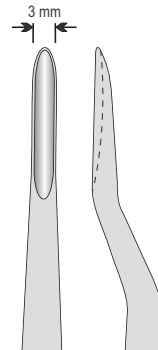


Fig. 2  
FI-03-088  
Bayonet Mesial

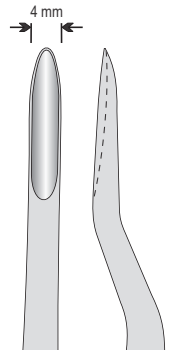
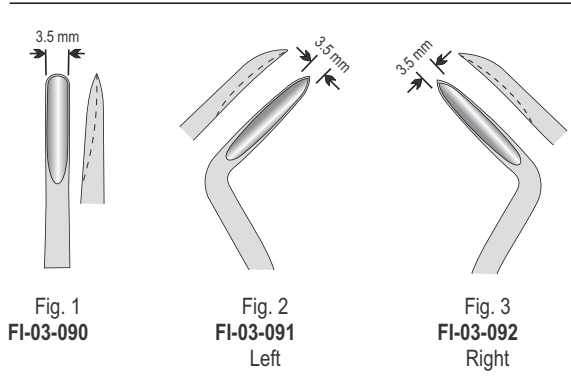


Fig. 3  
FI-03-089  
Bayonet Mesial

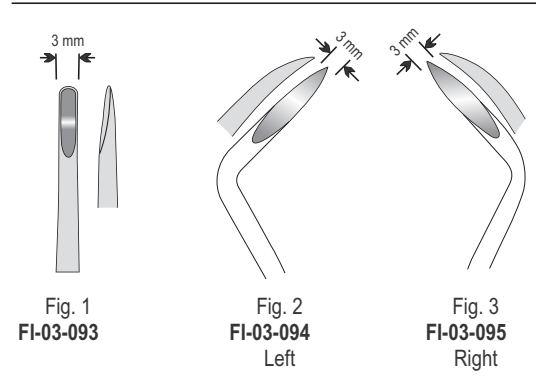




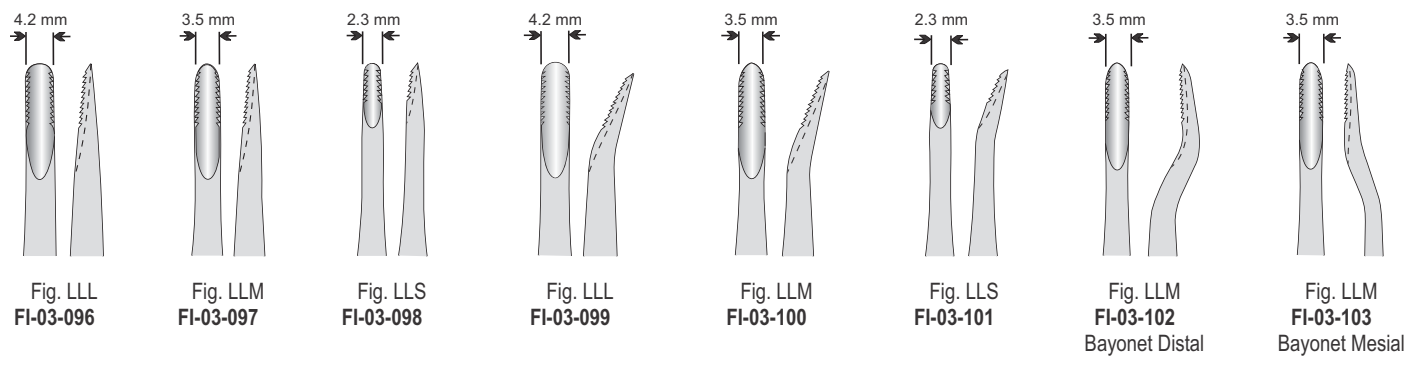
Flohr



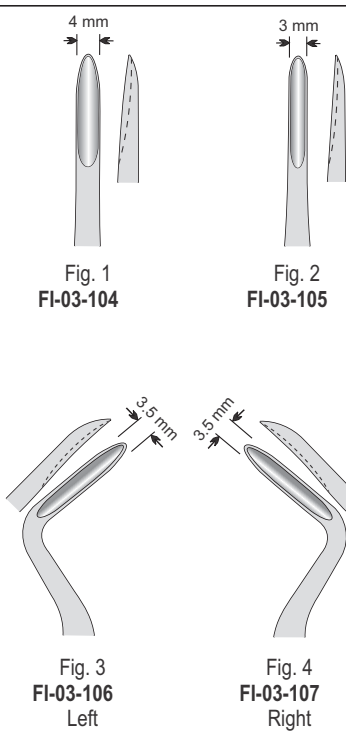
Friedman



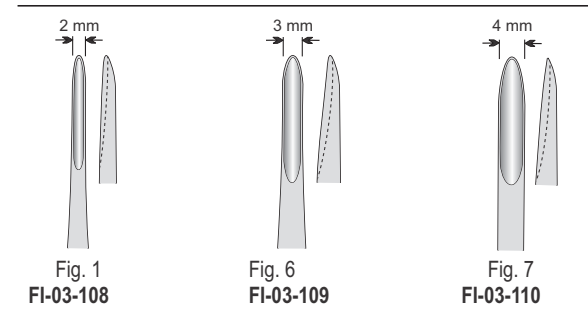
Lindo-Levian



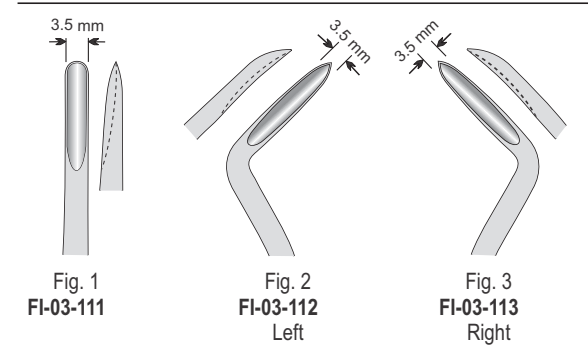
Hylin

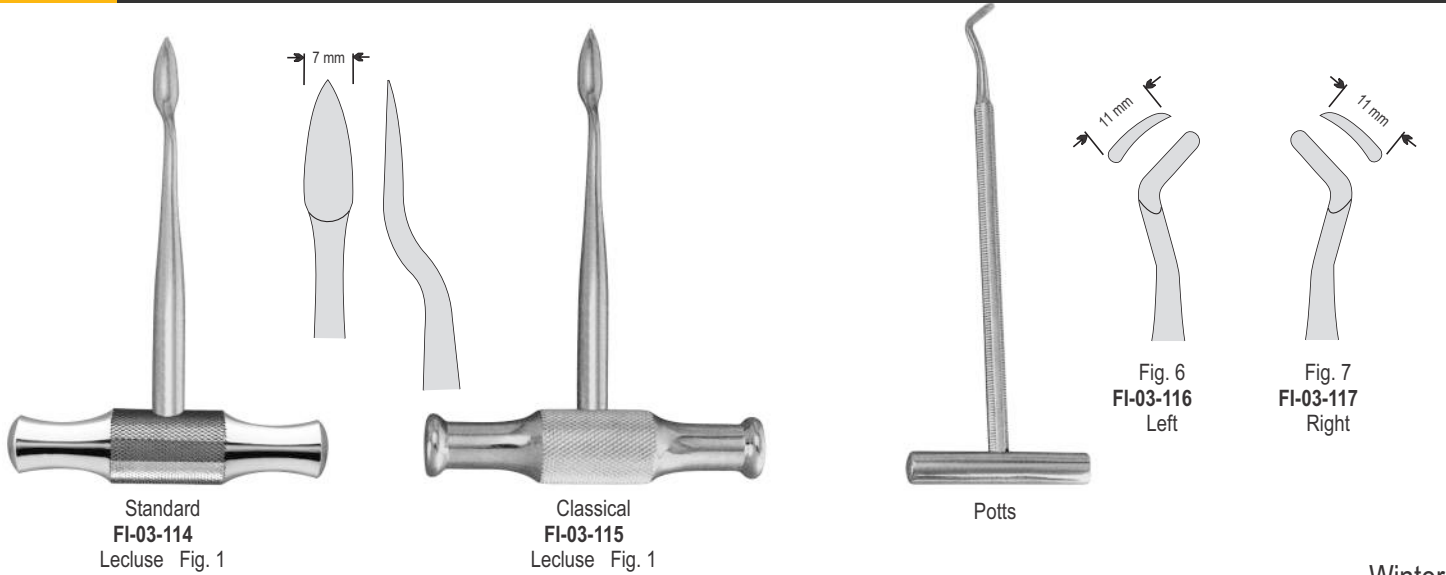


Bein

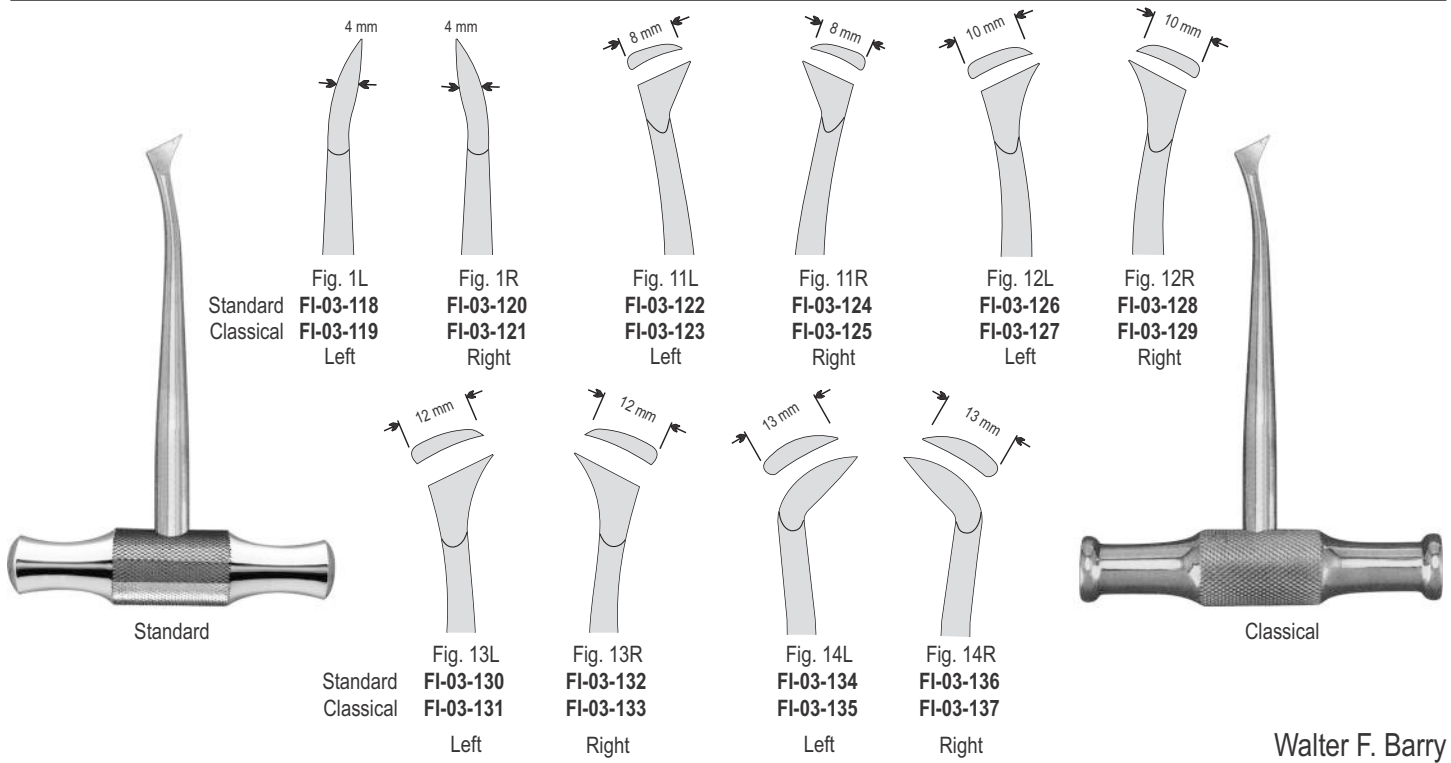


Flohr

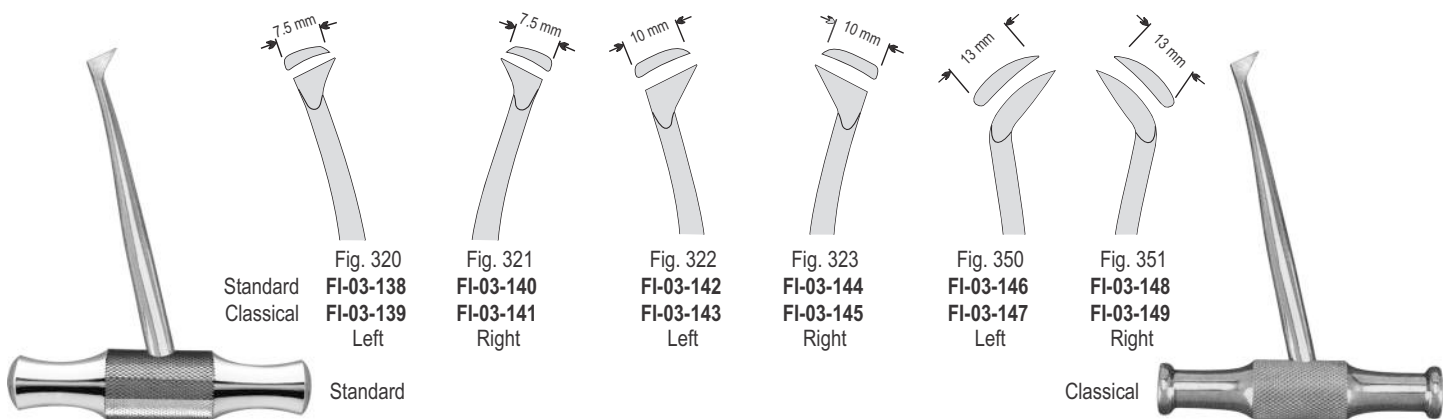




Winter



Walter F. Barry





04

Page 43-47

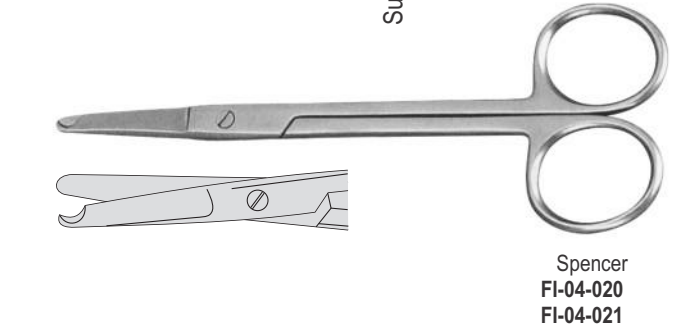
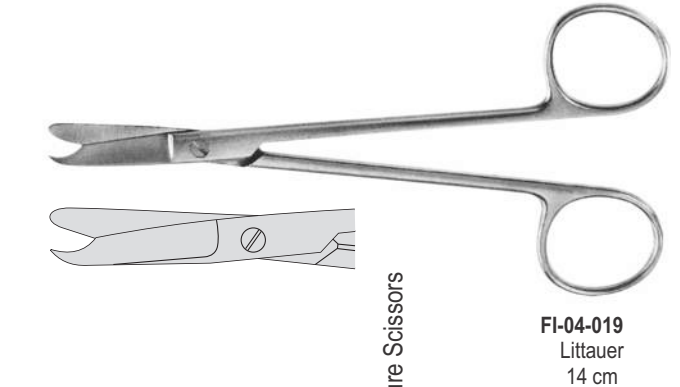
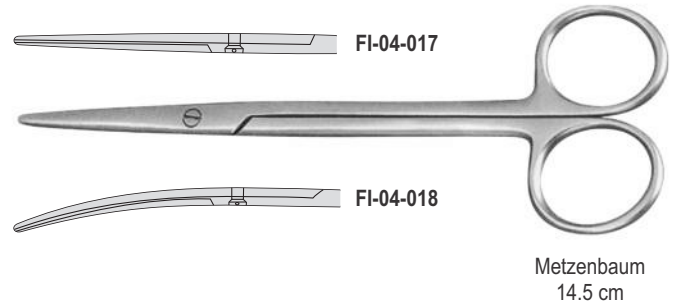
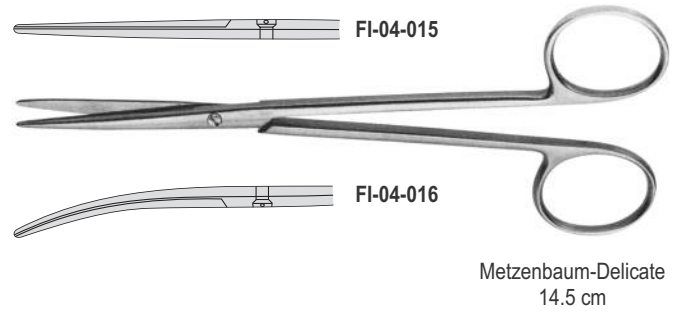
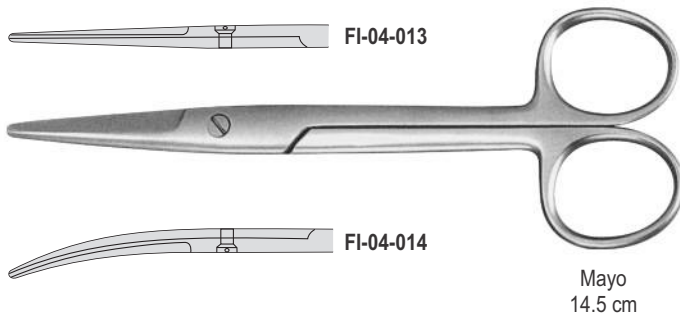
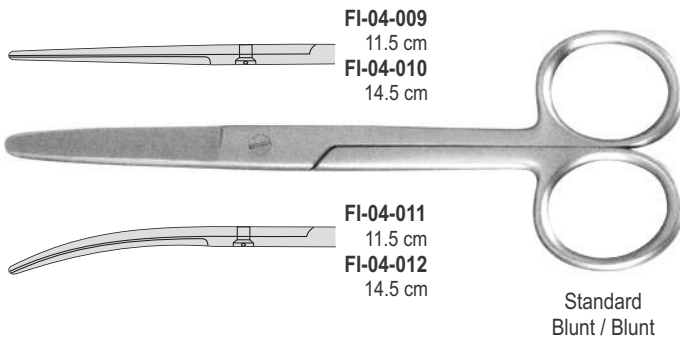
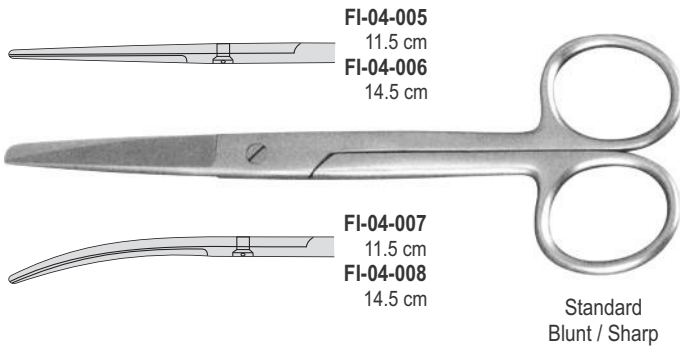
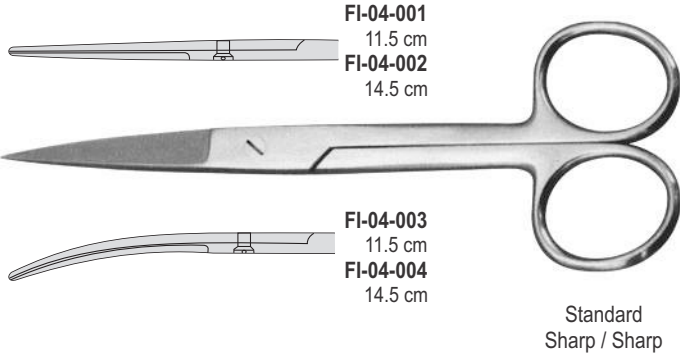
## scissors

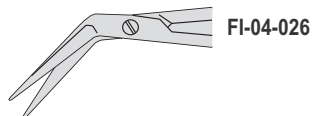
Operating Scissors

Scissors With Tungsten Carbide Inserts

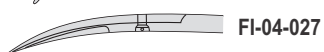
Micro Scissors

Super Cut Scissors





FI-04-026



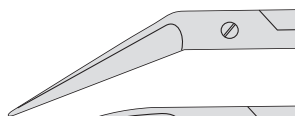
FI-04-027



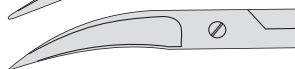
FI-04-028



Noyes / Castroviejo  
12 cm



FI-04-029



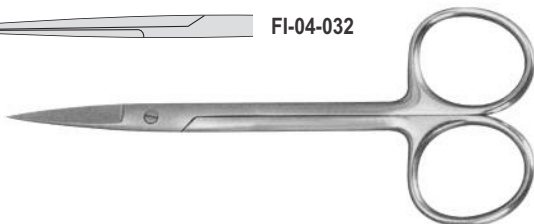
FI-04-030



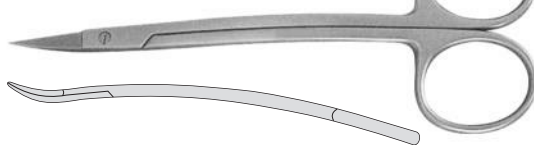
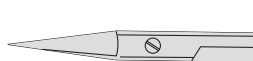
FI-04-031



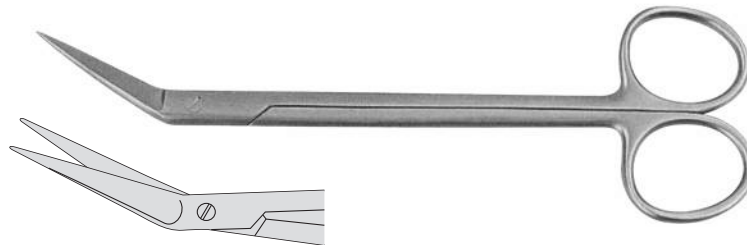
FI-04-032



Iris  
11.5 cm



FI-04-033  
La Grange  
11.5 cm



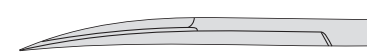
FI-04-034  
Kelly  
16 cm



FI-04-035



FI-04-036



Kelly  
16 cm



FI-04-037  
Goldman-Fox  
13 cm



FI-04-038



FI-04-039

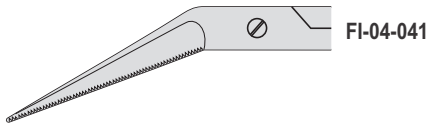
Goldman-Fox  
13 cm



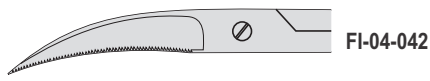
FI-04-040  
Universal  
18 cm

**Scissors, One Blade Serrated**

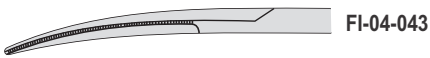
- One blade is with fine serrations to avoid tissue or ligature slippage.
- Manufactured from high quality stainless steel to provide longer-lasting cutting edge.
- Single black ring for easy identification.



FI-04-041



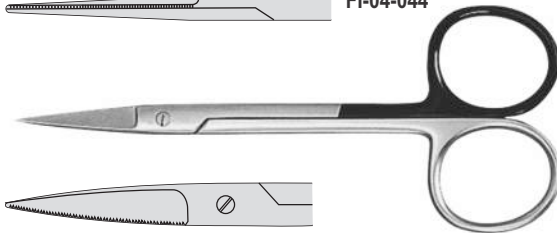
FI-04-042



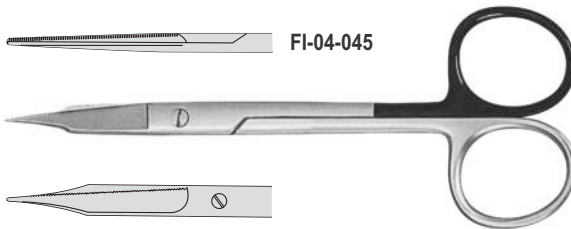
FI-04-043



FI-04-044



Iris  
11.5 cm

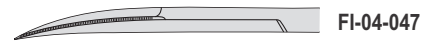


FI-04-045

Goldman-Fox  
13 cm



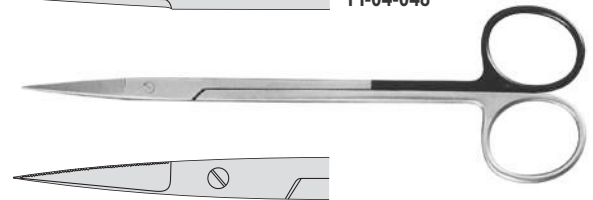
FI-04-046  
Goldman-Fox  
13 cm



FI-04-047



FI-04-048



Kelly  
16 cm



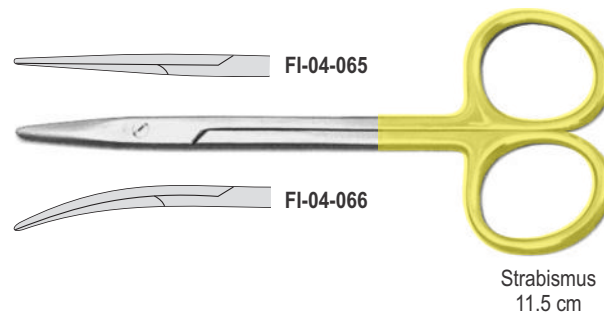
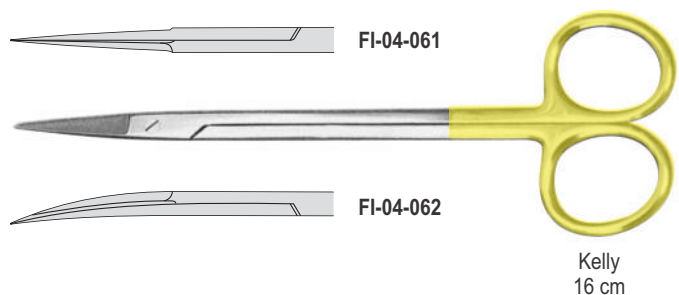
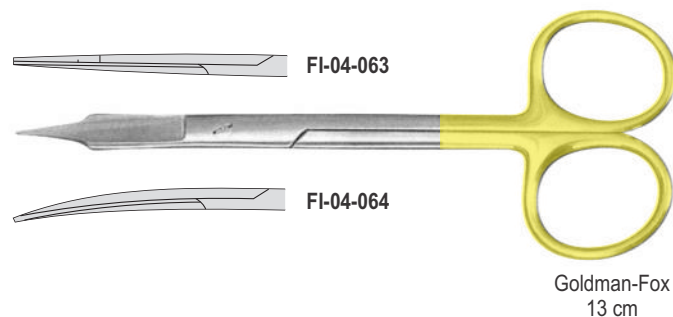
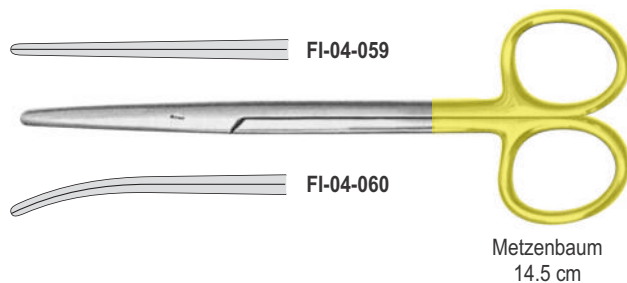
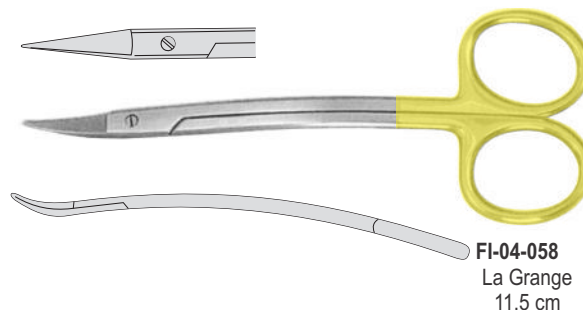
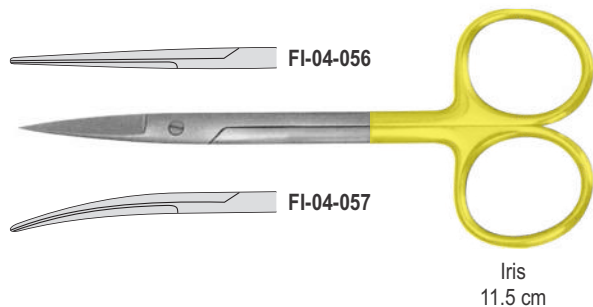
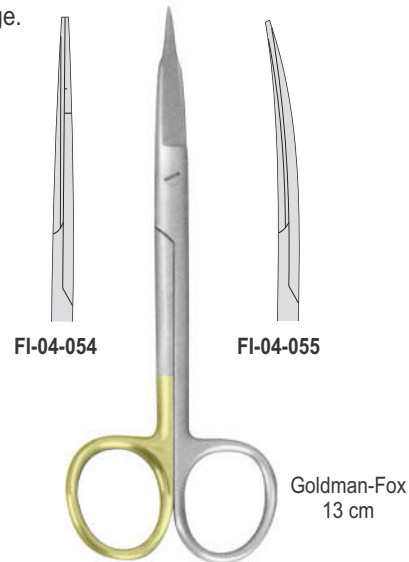
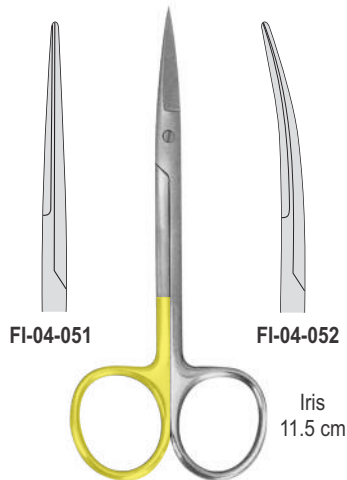
FI-04-049  
Locklin  
16 cm

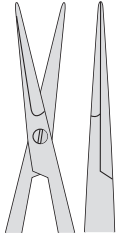


FI-04-050  
Locklin  
16 cm

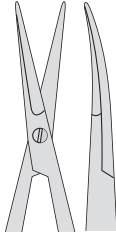
**Super-Cut**

- Cutting Blade horned to "razor" sharpness with opposing blade finished with fine serrations to avoid tissue slippage.
- Extremely smooth cutting with less trauma.
- Manufactured from high quality stainless steel to provide longer-lasting cutting edge.
- Single gold plated ring for easy identification.





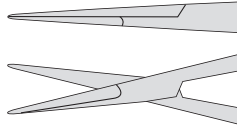
FI-04-067  
15 cm



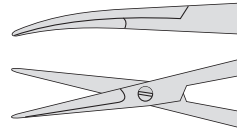
FI-04-068  
15 cm



Micro Scissor  
Stainless Steel



FI-04-069  
18 cm



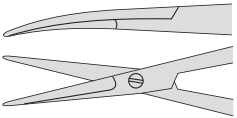
FI-04-070  
18 cm



Micro Scissor  
Stainless Steel

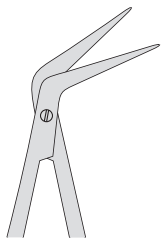


Micro Scissor  
Stainless Steel  
for ligature, one  
blade serrated

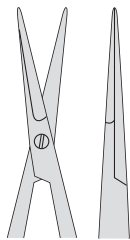


FI-04-071  
18 cm

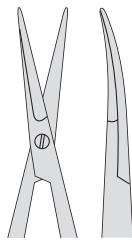
Micro Scissors with Titanium Stainless Steel Tips



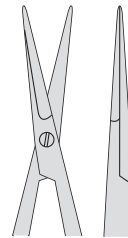
FI-04-072  
18 cm



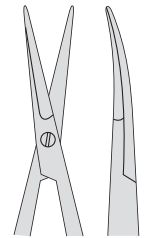
FI-04-073  
18 cm



FI-04-074  
18 cm



FI-04-075  
15.5 cm



FI-04-076  
15.5 cm







05

Page 48-56

## Tweezers

Tweezers

Dressing & Dissecting Forceps

Haemostatic Forceps

Needle Holders

Needle Holders with Tungsten Carbide Inserts

Micro Needle Holders & Forceps

Tweezers



FI-05-001  
College  
15 cm



FI-05-002  
College  
15 cm

Fig. 8



FI-05-003  
College-Locking  
15 cm



FI-05-004  
Flagg  
16 cm



FI-05-005  
Meriam  
16 cm



FI-05-006  
College  
15 cm



FI-05-007  
Flagg  
16 cm



FI-05-008  
Meriam  
16 cm



FI-05-009  
Perry  
13 cm



FI-05-010  
Perry  
13 cm



FI-05-011  
College TOE  
15 cm



FI-05-012  
Meriam TOE  
16 cm



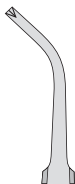
FI-05-013



FI-05-014



FI-05-015



FI-05-016



Gerald  
18 cm

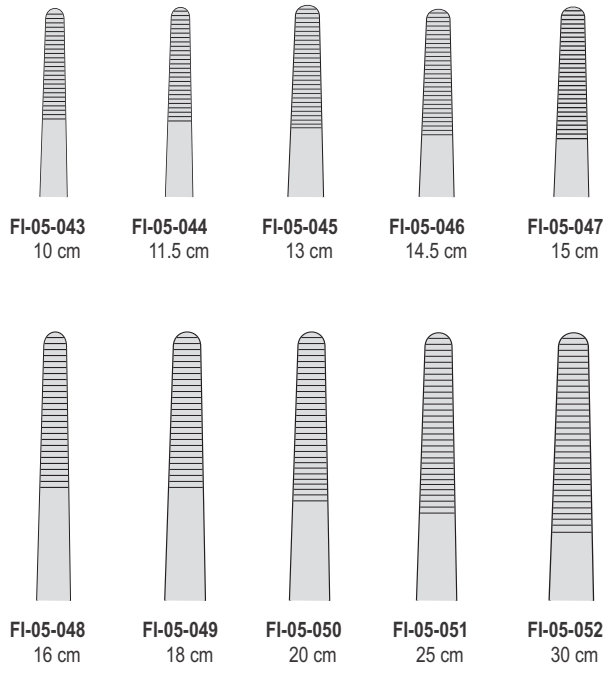


Gerald  
18 cm





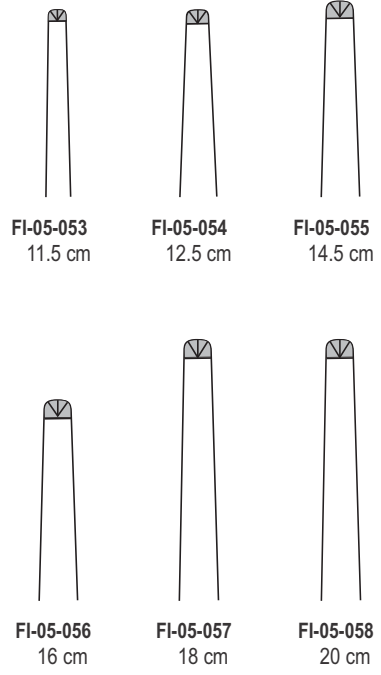
Standard Dressing Forceps



- FI-05-043 10 cm
- FI-05-044 11.5 cm
- FI-05-045 13 cm
- FI-05-046 14.5 cm
- FI-05-047 15 cm
- FI-05-048 16 cm
- FI-05-049 18 cm
- FI-05-050 20 cm
- FI-05-051 25 cm
- FI-05-052 30 cm

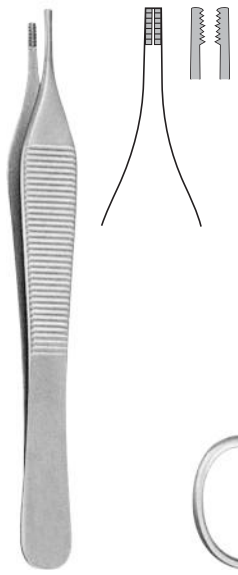


Standard Dissecting Forceps



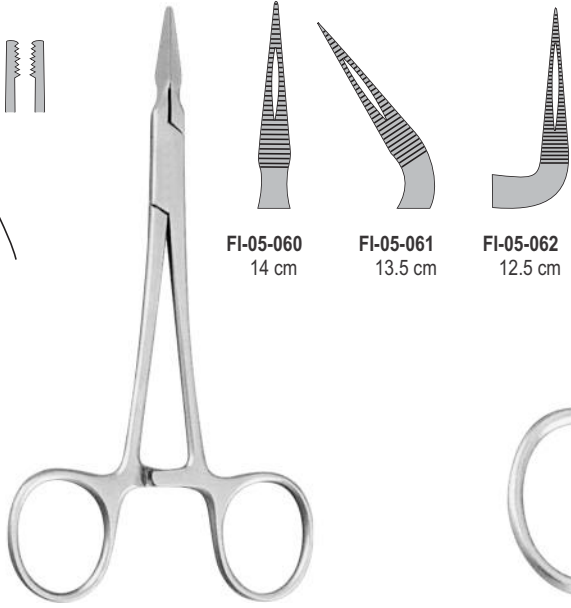
- FI-05-053 11.5 cm
- FI-05-054 12.5 cm
- FI-05-055 14.5 cm
- FI-05-056 16 cm
- FI-05-057 18 cm
- FI-05-058 20 cm

Tissue Forceps



FI-05-059 Adson-Brown 12 cm

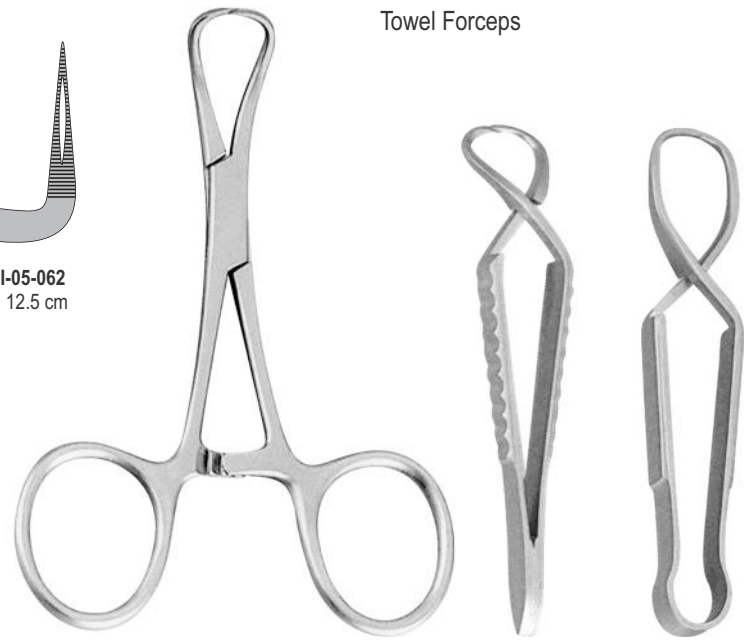
Splinter Forceps



Stieglitz

- FI-05-060 14 cm
- FI-05-061 13.5 cm
- FI-05-062 12.5 cm

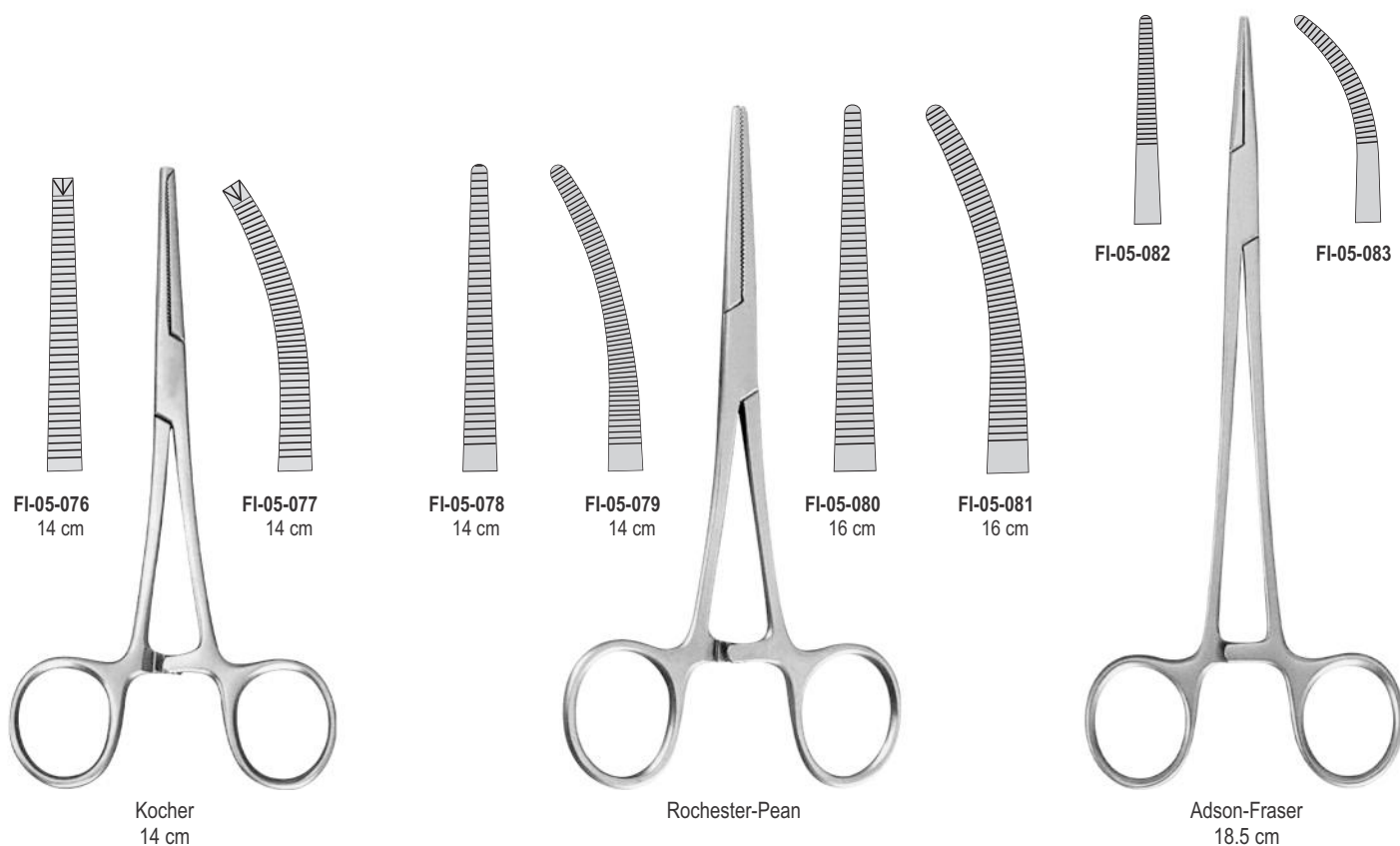
Towel Forceps

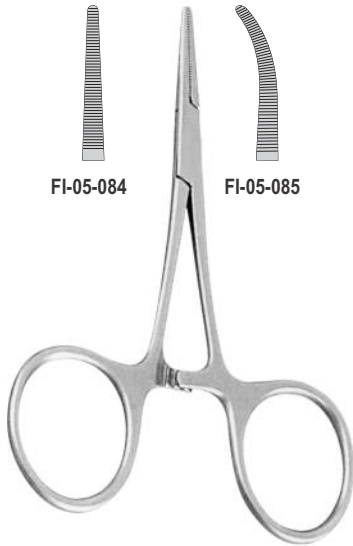
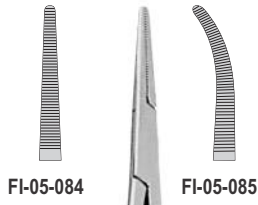


Backhaus  
FI-05-063 9 cm  
FI-05-064 11 cm  
FI-05-065 13 cm

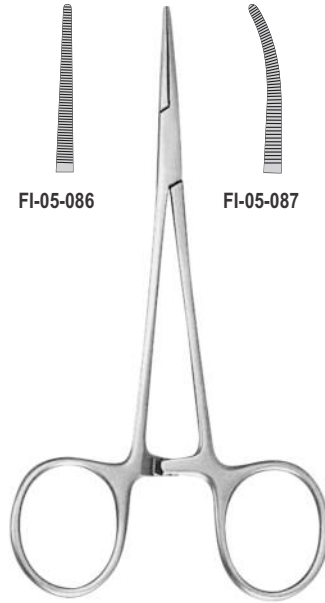
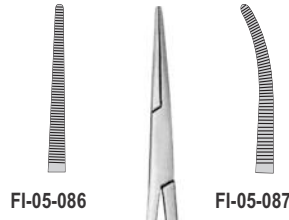
FI-05-066 Jones 9 cm

FI-05-067 Schaedel 9 cm

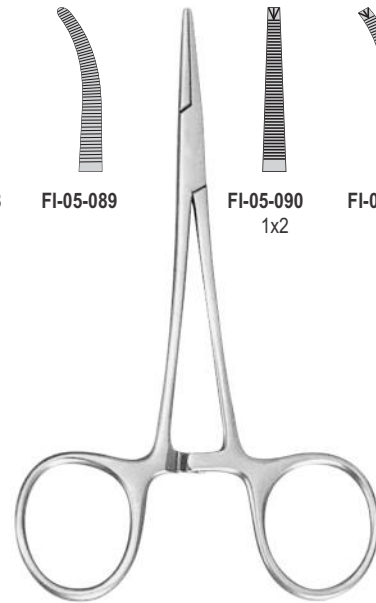
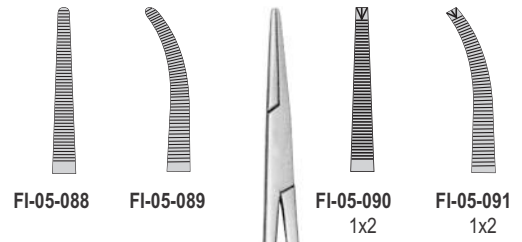




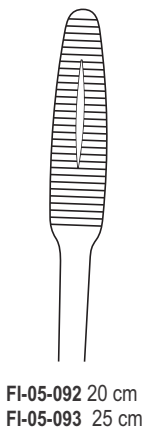
Hartman  
10 cm



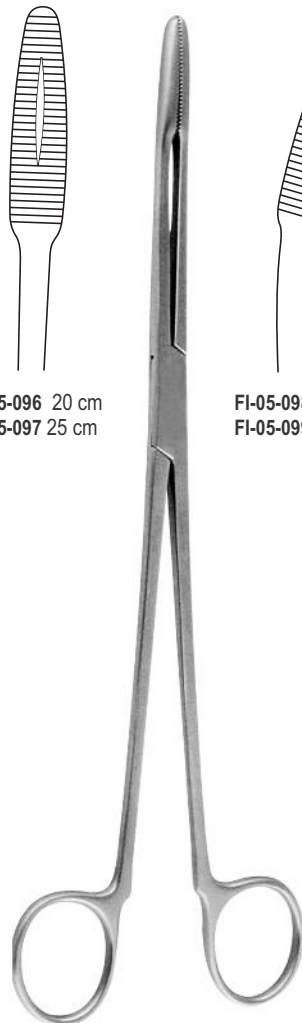
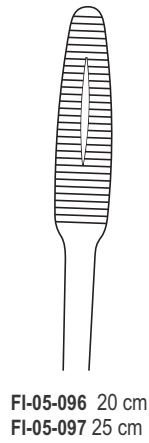
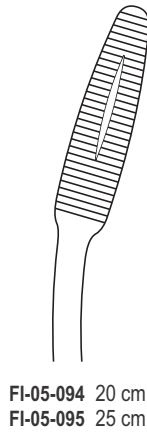
Micro Mosquito  
12.5 cm



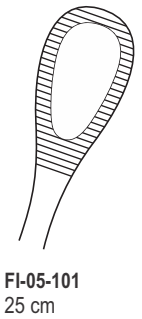
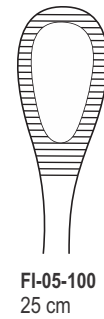
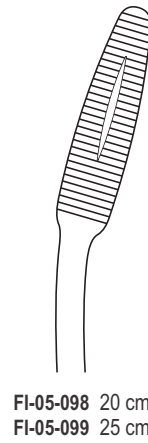
Halsted-Mosquito  
12.5 cm



Dressing Forceps  
Gross-Maier



Dressing Forceps  
Gross-Maier  
without ratchet



Sponge Forceps  
Forester



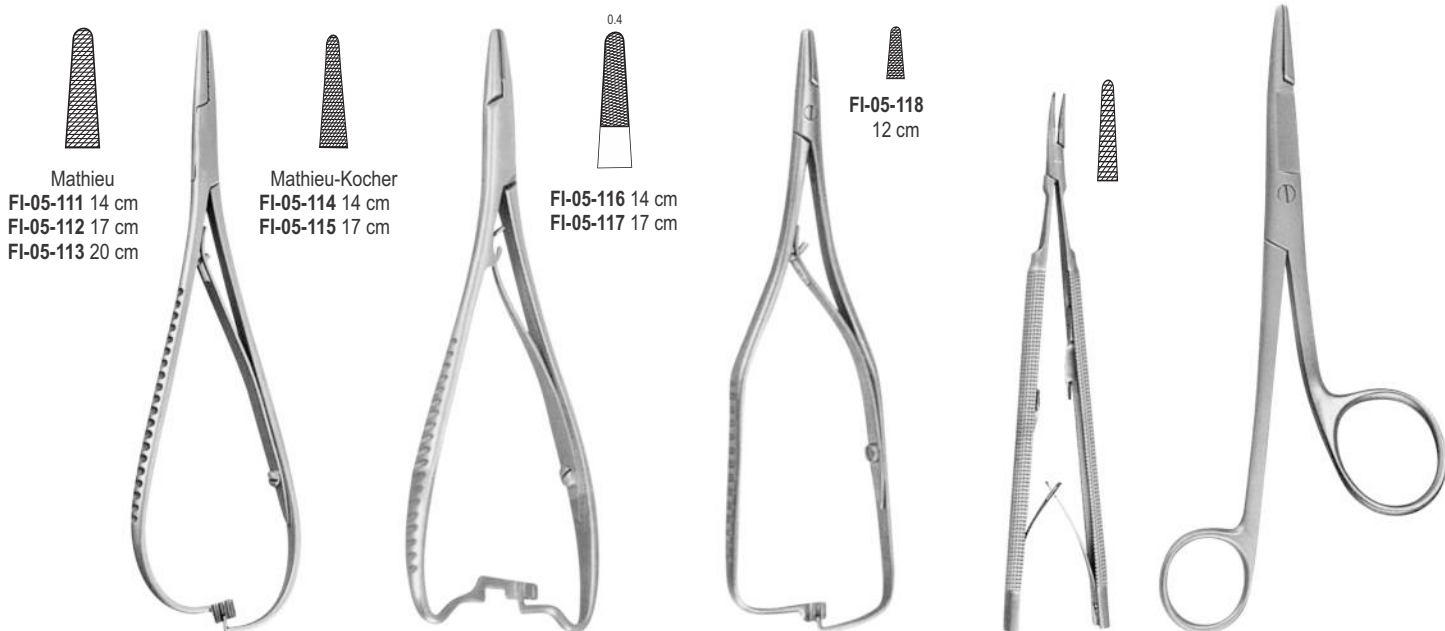
**FI-05-102**  
Derf  
12.5 cm

**FI-05-103**  
Olsen-Hegar  
with scissor  
14 cm

**FI-05-104**  
Baumgartner  
14.5 cm

**FI-05-105**  
Crilewood  
15 cm

Mayo-Hegar  
**FI-05-106** 14 cm  
**FI-05-107** 15 cm  
**FI-05-108** 16 cm  
**FI-05-109** 18 cm  
**FI-05-110** 20 cm



Mathieu  
**FI-05-111** 14 cm  
**FI-05-112** 17 cm  
**FI-05-113** 20 cm

Mathieu-Kocher  
**FI-05-114** 14 cm  
**FI-05-115** 17 cm

0.4  
**FI-05-116** 14 cm  
**FI-05-117** 17 cm

**FI-05-118**  
12 cm

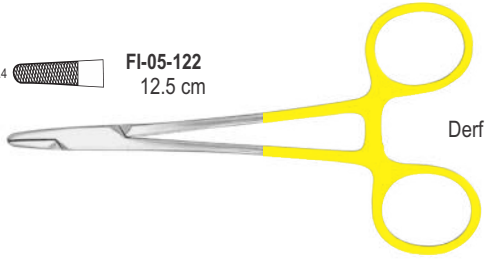
Mathieu

Boynton

**FI-05-119**  
Castroviejo  
13 cm

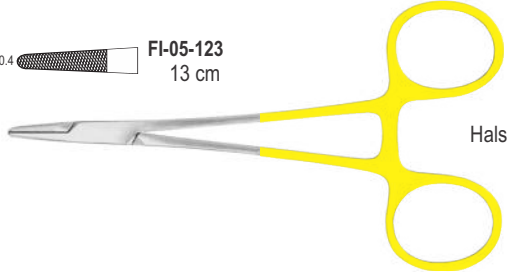
Gillies with Scissor 16 cm  
**FI-05-120** Left handed  
**FI-05-121** Right handed

0.4 FI-05-122  
12.5 cm



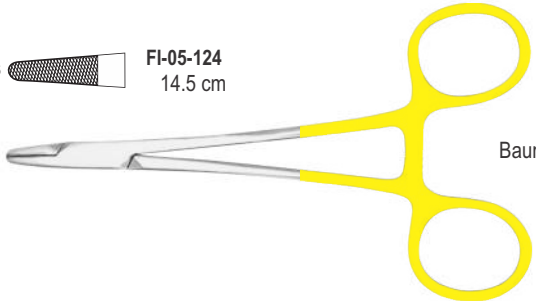
Derf

0.4 FI-05-123  
13 cm



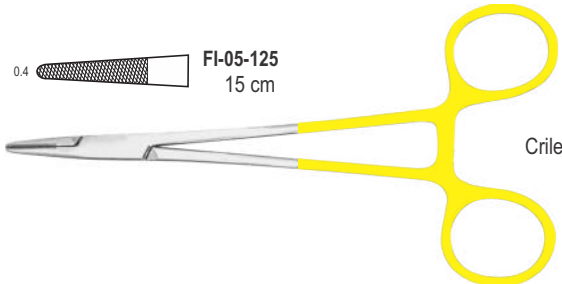
Halsey

0.5 FI-05-124  
14.5 cm



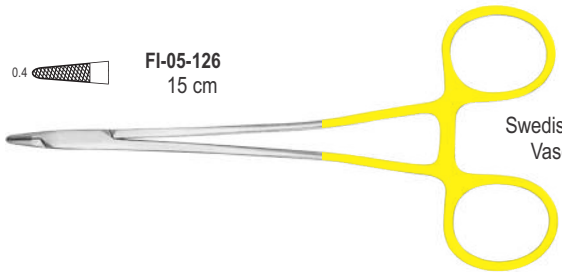
Baumgartner

0.4 FI-05-125  
15 cm



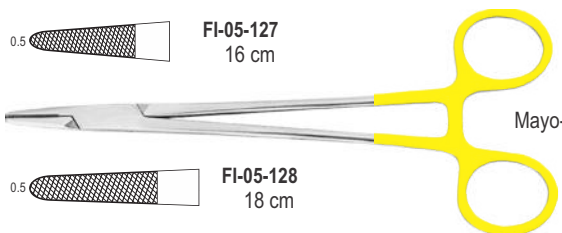
Crilewood

0.4 FI-05-126  
15 cm



Swedish-Micro  
Vascular

0.5 FI-05-127  
16 cm



Mayo-Hegar

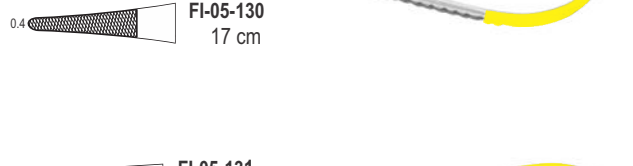
0.5 FI-05-128  
18 cm

0.4 FI-05-129  
14 cm



Mathieu  
Kocher

0.4 FI-05-130  
17 cm

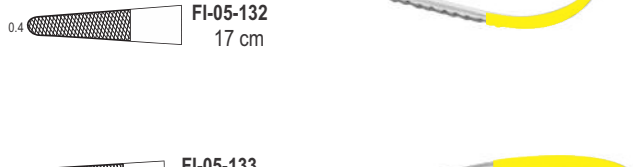


Mathieu

0.4 FI-05-131  
14 cm



0.4 FI-05-132  
17 cm



Mathieu

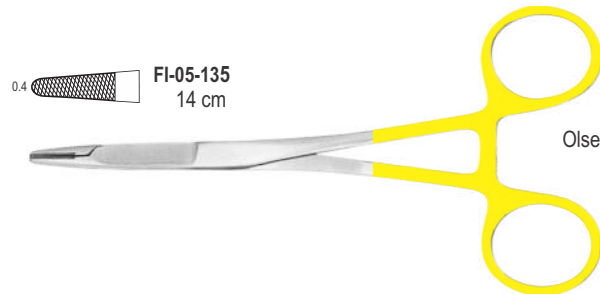
0.4 FI-05-133  
14 cm



0.4 FI-05-134  
17 cm



0.4 FI-05-135  
14 cm



Olsen-Hegar

0.5 FI-05-136  
18 cm



Toennis



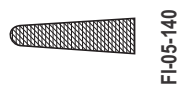
Needle Holders with Tungsten Carbide inserts



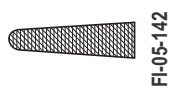
Castroviejo  
14 cm



Castroviejo  
14 cm



Castroviejo  
14 cm



Castroviejo  
14 cm



Castroviejo  
14 cm



Castroviejo  
14 cm



Castroviejo  
14 cm

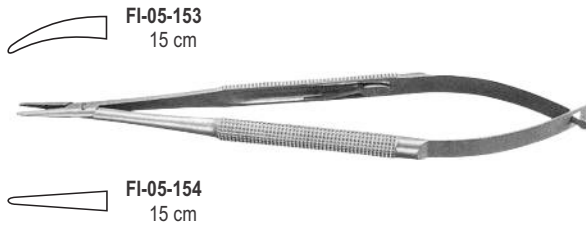


Castroviejo  
14 cm

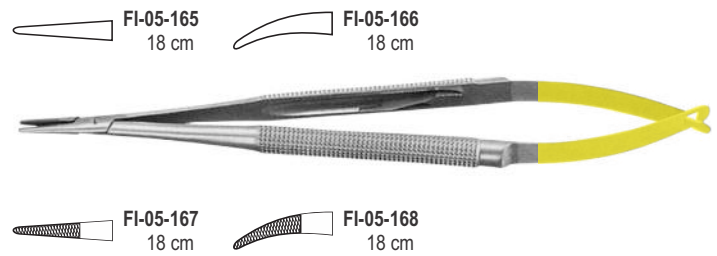
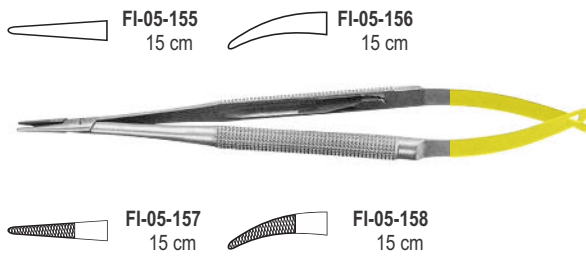


Castroviejo  
18 cm

Micro Needle Holders Stainless Steel



Micro Needle Holders Stainless Steel  
with Tungsten Carbide Inserts



Micro Forceps Stainless Steel





06

Page 57-77

## Implantology instruments & Mouth Gags

Mouth Gags

Tongue Depressors

Lips & Cheek Retractors

Retractors & Forceps

Bone Instruments & Mallets

Implantology Instruments

Periosteal Elevators

Periodontal Instruments

Bone Curettes

Files

Surgery Instruments



**FI-06-001**  
 Heister  
 Maunder Wood  
 9.5 cm



**FI-06-002**  
 Obwegeser 11 cm  
 Spreading 47 mm



**FI-06-003**  
 Heister  
 13 cm



Molt  
**FI-06-004** 10 cm  
**FI-06-005** 11 cm  
**FI-06-006** 14 cm



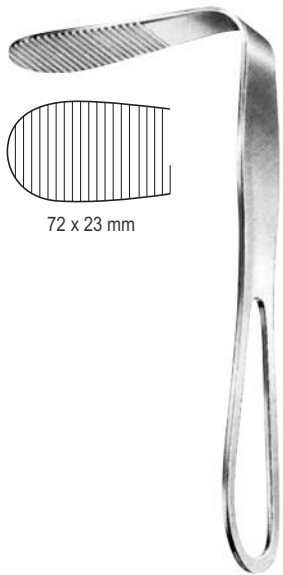
Roser-Konig  
**FI-06-007** 16 cm  
**FI-06-008** 19 cm



**FI-06-009**  
 Denhardt  
 13 cm



**FI-06-010**  
 Fergusson - Ackland  
 14.5 cm



72 x 23 mm

**FI-06-011**  
Hartmann  
15 cm



**FI-06-012**  
Doyen Tongue Spatula  
13.5 cm



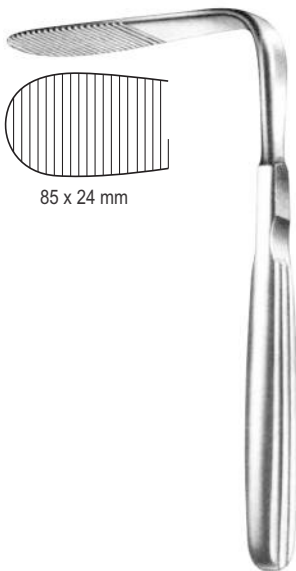
**FI-06-013**  
14.5 cm



**FI-06-014**  
18 cm

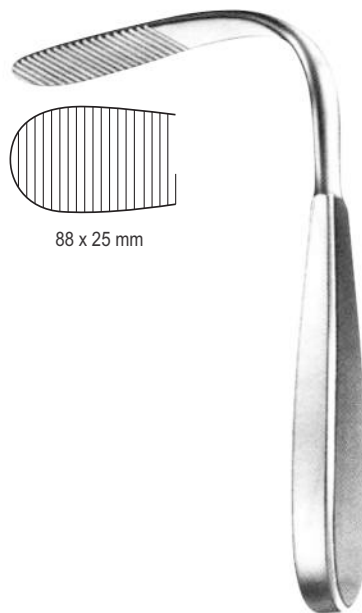


**FI-06-015**  
Bruenings  
19 cm



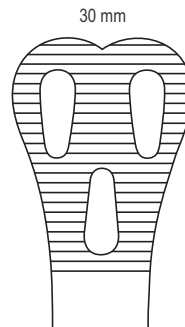
85 x 24 mm

**FI-06-016**  
Tobold  
15 cm



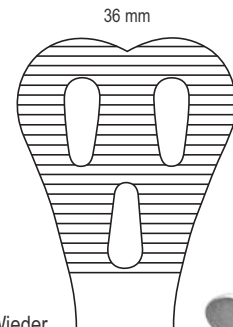
88 x 25 mm

**FI-06-017**  
Tobold  
16 cm



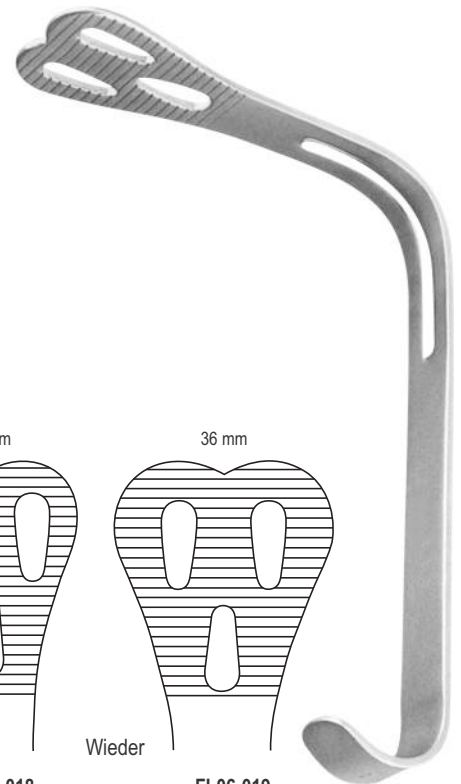
30 mm

**FI-06-018**  
14 cm



36 mm

**FI-06-019**  
15 cm



Wieder



**FI-06-020**  
Obwegeser Chin  
Retractor  
16.5 cm



Obwegeser 16 cm  
**FI-06-021** 8 mm  
**FI-06-022** 10 mm



**FI-06-023** 43 x 11 mm  
**FI-06-024** 57 x 11 mm  
**FI-06-025** 83 x 16 mm



35 x 11 mm

**FI-06-026**  
Obwegeser  
Spina-nasalis retractor  
22 cm



72 x 11 mm

**FI-06-027**  
Obwegeser  
Ramus retractor for  
separation of ramus & tissue  
22 cm



**FI-06-028**  
Simplex  
10.5 cm



30x19 mm

33x25 mm

**FI-06-029**  
Kilner  
15 cm



**FI-06-030**  
Minnesota  
14 cm



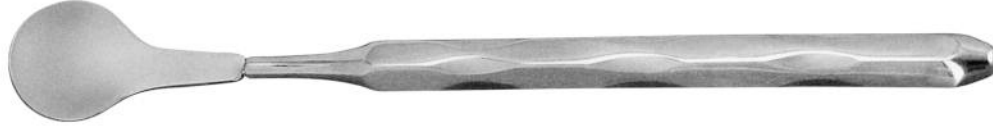
**FI-06-031**  
Cawood-Minnesota  
15 cm



**FI-06-032**  
Austin



**FI-06-033**  
 Hilger  
 Fits any simple stem mouth mirror handle



**FI-06-034**  
 Hilger  
 with handle



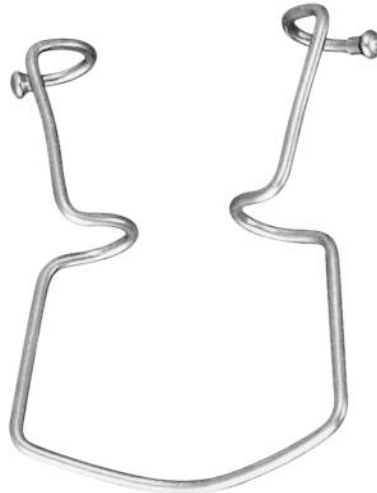
**FI-06-035**  
 20 cm

Finger protectors



Langenbeck

**FI-06-036** Small  
**FI-06-037** Medium  
**FI-06-038** Large



**FI-06-039**  
 Oringer  
 11.5 cm



**FI-06-040**  
 Obwegeser Cheek Retractor  
 12cm



**FI-06-041**  
 Columbia  
 14.5 cm



Sternberg

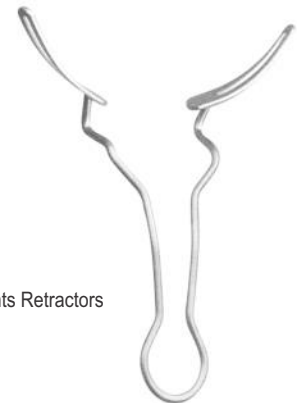
**FI-06-042** 12 cm  
**FI-06-043** 14 cm  
**FI-06-044** 15 cm



Vestibulum  
**FI-06-045**



**FI-06-046**  
 MRU

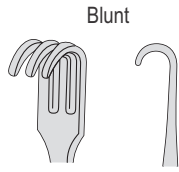


Implants Retractors

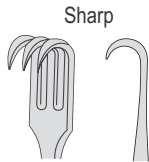
**FI-06-047**  
 MRU



Senn-Miller  
16 cm



Blunt  
FI-06-048



Sharp  
FI-06-049

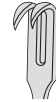


J & W  
16 cm

Sharp



FI-06-050



FI-06-051



FI-06-052



FI-06-053



J & W  
16 cm

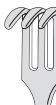
Blunt



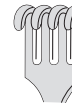
FI-06-054



FI-06-055



FI-06-056



FI-06-057



FI-06-058  
Collin Tongue holding forcep  
17 cm

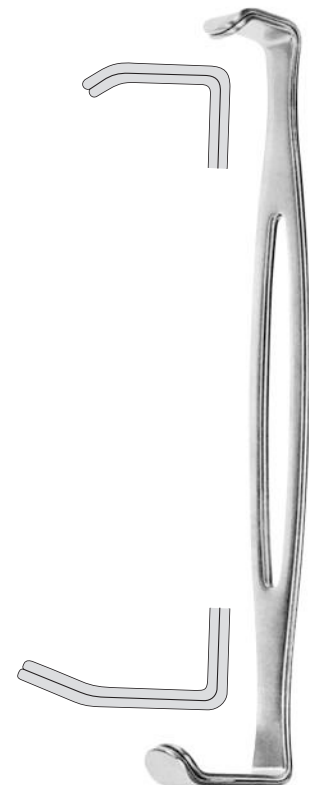


Young Tongue holding forcep  
FI-06-059 15 cm  
FI-06-060 17 cm

60-178-00  
Rubber Pad pair



FI-06-061  
Farabeuf 12 cm  
Pair

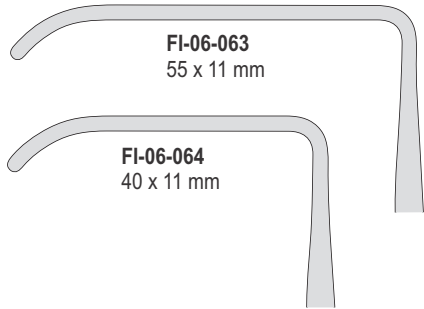


FI-06-062  
Parker-Langenbeck 21 cm  
Pair



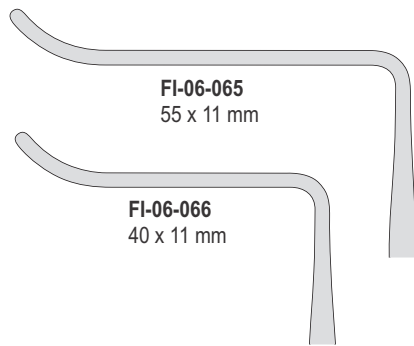


Kocher  
21.5 cm



FI-06-063  
55 x 11 mm

FI-06-064  
40 x 11 mm

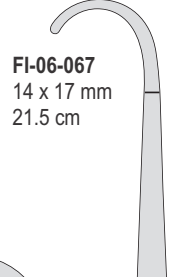


FI-06-065  
55 x 11 mm

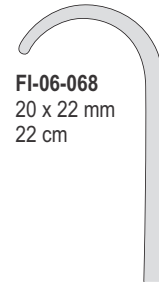
FI-06-066  
40 x 11 mm



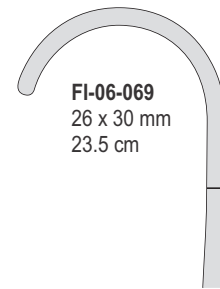
Middeldorph



FI-06-067  
14 x 17 mm  
21.5 cm



FI-06-068  
20 x 22 mm  
22 cm



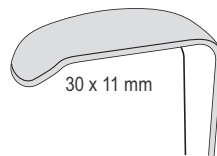
FI-06-069  
26 x 30 mm  
23.5 cm



■ Langenbeck  
22 cm

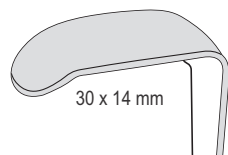


● Langenbeck  
22 cm



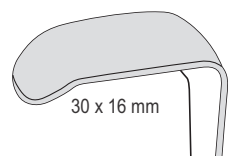
30 x 11 mm

■ FI-06-070  
● FI-06-075



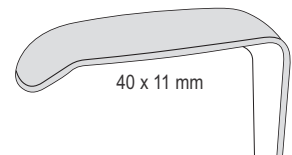
30 x 14 mm

■ FI-06-071  
● FI-06-076



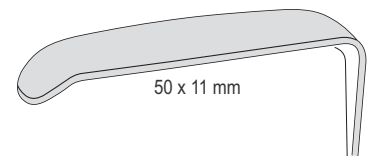
30 x 16 mm

■ FI-06-072  
● FI-06-077



40 x 11 mm

■ FI-06-073  
● FI-06-078



50 x 11 mm

■ FI-06-074  
● FI-06-079



**FI-06-080**  
Neukam  
Only Frame for Mouth Gag



Fig. 1  
**FI-06-081**  
Fig. 2  
**FI-06-082**  
Fig. 3  
**FI-06-083**

Tongue Depressors  
fenestrated blade for suction

**FI-06-084**  
Neukam  
Complete, with frame & 3 tongue depressors



**FI-06-085**  
Kilner-Doughty  
Only Frame for Mouth Gag  
14.5 cm



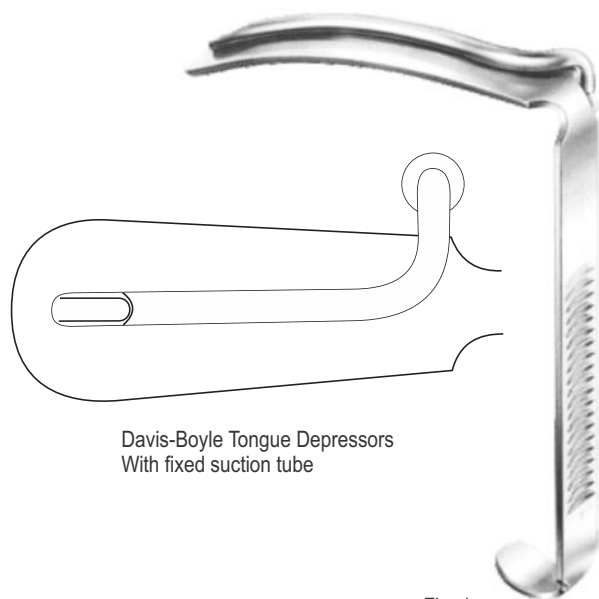
**FI-06-086**  
Palate plate

Fig. 1  
**FI-06-087**  
68 x 30 mm  
Fig. 2  
**FI-06-088**  
77 x 34 mm  
Fig. 3  
**FI-06-089**  
82 x 39 mm



Kilner-Doughty  
Tongue Depressors  
fenestrated blade for suction

**FI-06-090**  
Kilner-Doughty  
Complete, with frame, 3 tongue depressors,  
2 tooth plates & 1 palate plate



Davis-Boyle Tongue Depressors  
With fixed suction tube

Fig. 1  
**FI-06-091**  
110 x 28 mm



Fig. 2  
**FI-06-092**  
95 x 27 mm



Fig. 3  
**FI-06-094**  
80 x 27 mm



Fig. 4  
**FI-06-093**  
65 x 26 mm



Fig. 5  
**FI-06-095**  
30 x 20 mm  
Without Suction Tube



**FI-06-096**  
Frame for Mouth Gag with joint  
14.5 cm

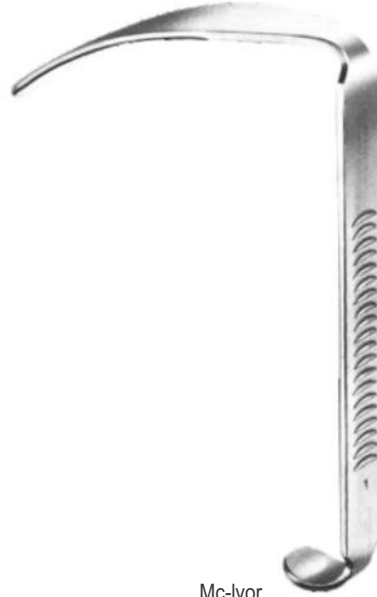
**FI-06-097**  
Frame for Mouth Gag

**FI-06-098**  
Silicone inlay  
14.5 cm

**FI-06-099**  
Davis-Boyle  
Complete, consisting of frame  
& 5 tongue depressors No. 1 to 5



**FI-06-100**  
Mc-Ivor  
Frame for Mouth Gag



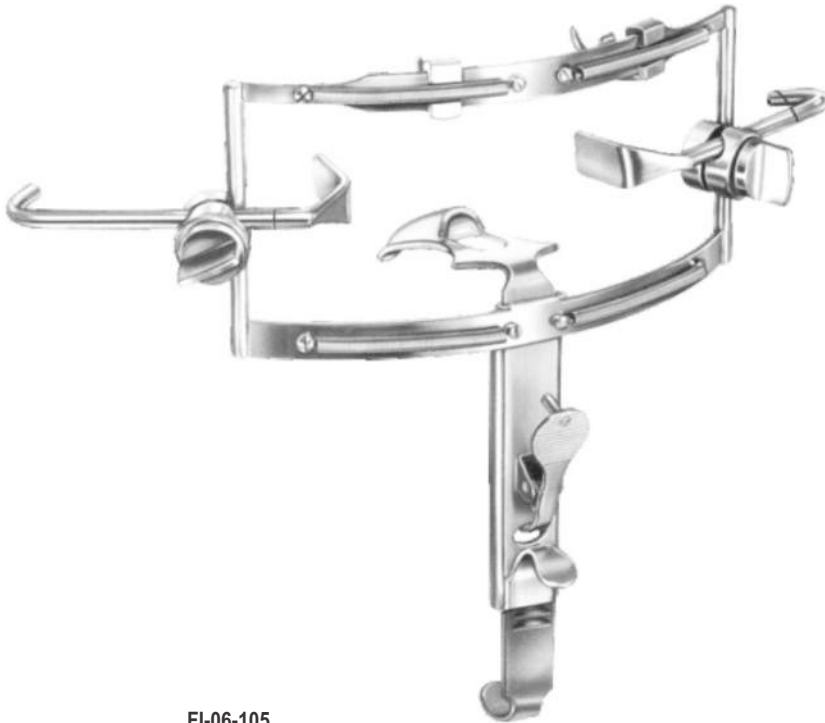
Mc-Ivor  
Tongue Depressors

Fig. 1  
**FI-06-101**  
100 x 25 mm

Fig. 2  
**FI-06-102**  
85 x 25 mm

Fig. 3  
**FI-06-103**  
75 x 25 mm

**FI-06-104**  
Mc-Ivor  
Complete, with 3 tongue depressors



**FI-06-105**  
Dingmann  
Complete, with frame, 3 tongue depressors,  
& 2 adjustable lateral blades



Dingmann  
Tongue Depressors

Fig. 1  
**FI-06-106**  
62 x 26 mm

Fig. 2  
**FI-06-107**  
65 x 30 mm

Fig. 3  
**FI-06-108**  
78 x 32 mm



Jennings  
FI-06-109 10.5 cm  
FI-06-110 12.5 cm  
FI-06-111 14.5 cm  
FI-06-112 16.5 cm

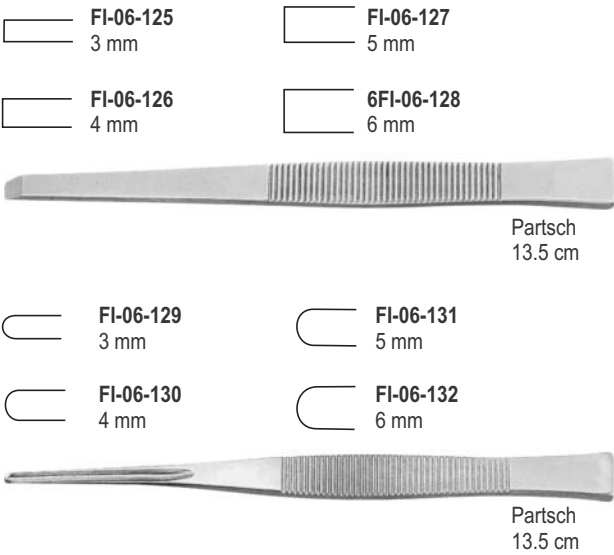
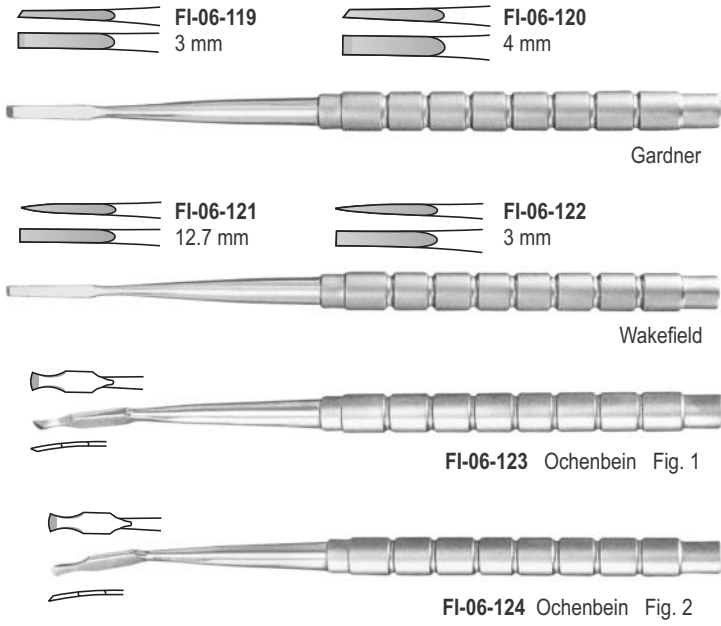


Whitehead Mouth Gag  
FI-06-113 11cm  
FI-06-114 13cm  
FI-06-115 15cm

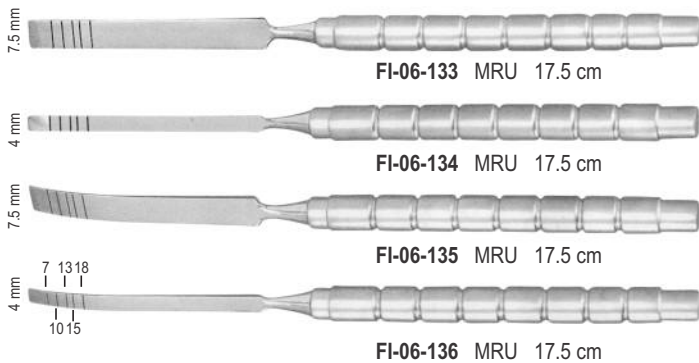


Cheek Retractor  
FI-06-116 Small  
FI-06-117 Medium  
FI-06-118 Large

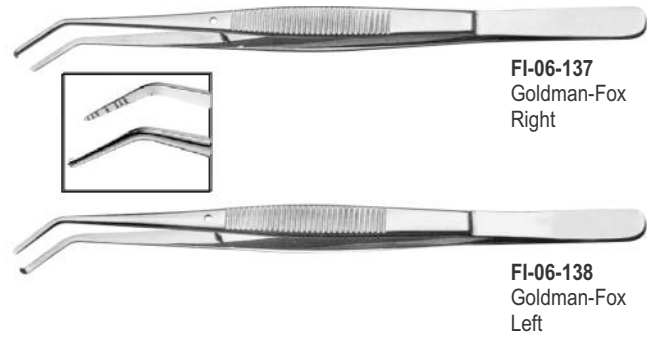
Chisels & Gouges



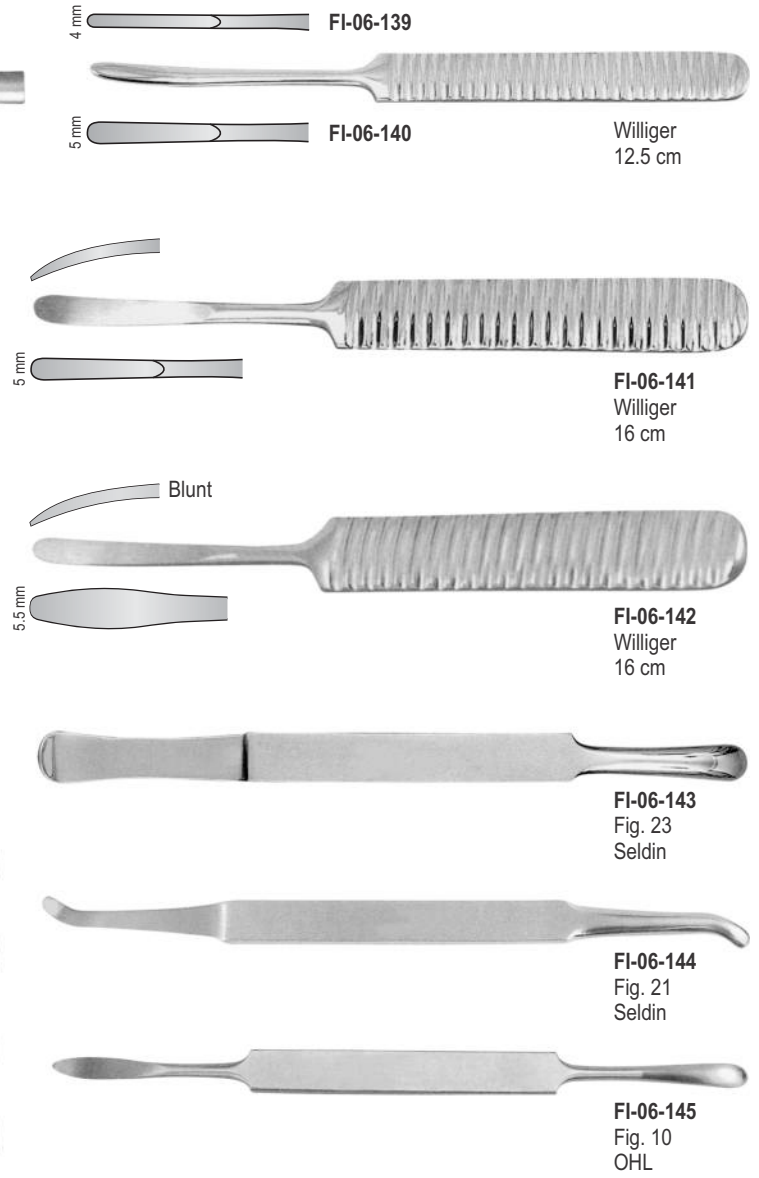
Osteotomes



Pocket Markers



Elevators & Raspatories



Osteotomes

# 1	Diam.
0	Ø 1.60
7.5	Ø 1.80
10	Ø 2.00
13.5	Ø 2.40
15.5	Ø 3.60

# 2	Diam.
0	Ø 1.90
7.5	Ø 2.20
10	Ø 2.35
13.5	Ø 3.30
15.5	Ø 3.40
23.5	Ø 4.50

# 3	Diam.
0	Ø 2.80
7.5	Ø 3.20
10.5	Ø 3.35
13.5	Ø 3.60
21	Ø 4.40

# 4	Diam.
0	Ø 3.10
7.5	Ø 3.70
10.5	Ø 3.90
15.5	Ø 4.30

# 5	Diam.
0	Ø 3.90
10	Ø 5.00
13	Ø 5.20
20.5	Ø 6.30

# 6	Diam.
0	Ø 5.50
10	Ø 6.20
13	Ø 6.30



15.5 cm

# 1  
Ø 1.6 mm



FI-06-146  
15.5 cm

# 2  
Ø 1.9 mm



FI-06-147  
15.5 cm

# 3  
Ø 2.8 mm



FI-06-148  
15.5 cm

# 4  
Ø 3.10 mm



FI-06-149  
15.5 cm

# 5  
Ø 3.90 mm



FI-06-150  
15.5 cm

# 6  
Ø 5.50 mm



FI-06-151  
15.5 cm

# 1	Diam.
0	Ø 1.50
5	Ø 1.90
8	Ø 2.20
10	Ø 2.40
12	Ø 2.60
14	Ø 2.80

# 2	Diam.
0	Ø 2.10
5	Ø 2.60
8	Ø 2.80
10	Ø 3.00
12	Ø 3.20
14	Ø 3.40

# 3	Diam.
0	Ø 2.60
5	Ø 3.00
8	Ø 3.30
10	Ø 3.50
12	Ø 3.70
14	Ø 3.90

# 4	Diam.
0	Ø 3.00
5	Ø 3.50
8	Ø 3.80
10	Ø 4.00
12	Ø 4.20
14	Ø 4.40

# 5	Diam.
0	Ø 3.50
5	Ø 3.90
8	Ø 4.20
10	Ø 4.40
12	Ø 4.60
14	Ø 4.80

Spelling Straight  
Bone Pusher

# 1  
Ø 1.5 mm



FI-06-152  
15.5 cm

# 2  
Ø 2.1 mm



FI-06-153  
15.5 cm

# 3  
Ø 2.6 mm



FI-06-154  
15.5 cm

# 4  
Ø 3.0 mm



FI-06-155  
15.5 cm

# 5  
Ø 3.5 mm



FI-06-156  
15.5 cm

Ø 2.8 mm



FI-06-157  
15.5 cm

Ø 3.5 mm



FI-06-158  
15.5 cm

Ø 4.2 mm

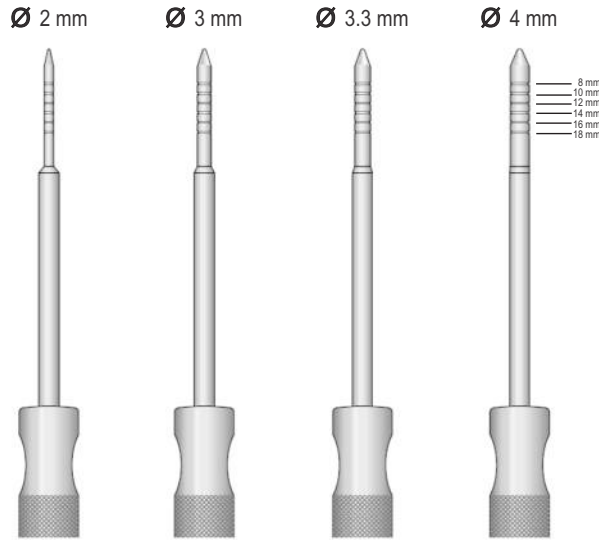


FI-06-159  
15.5 cm



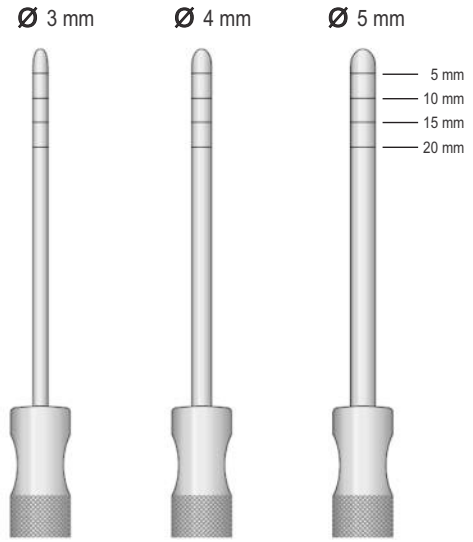
15 cm

Pointed



**FI-06-160** 15 cm  
**FI-06-161** 15 cm  
**FI-06-162** 15 cm  
**FI-06-163** 15 cm

Convex Tips

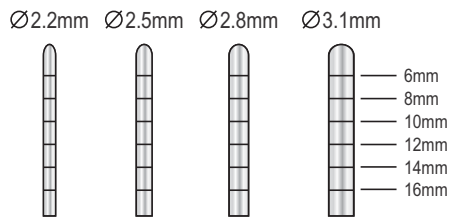


**FI-06-164** 15 cm  
**FI-06-165** 15 cm  
**FI-06-166** 15 cm

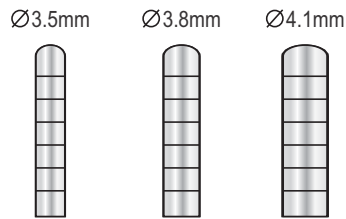
Convex Tips



16.5 cm  
Str



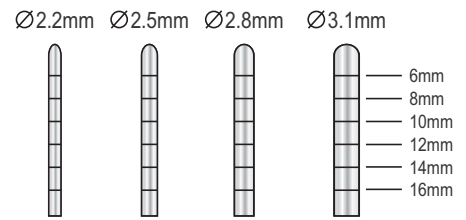
**FI-06-167** **FI-06-168** **FI-06-169** **FI-06-170**



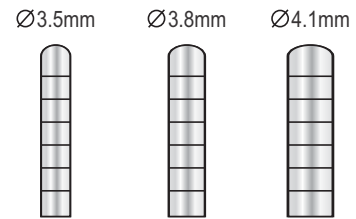
**FI-06-171** **FI-06-172** **FI-06-173**



16.5 cm  
Cvd



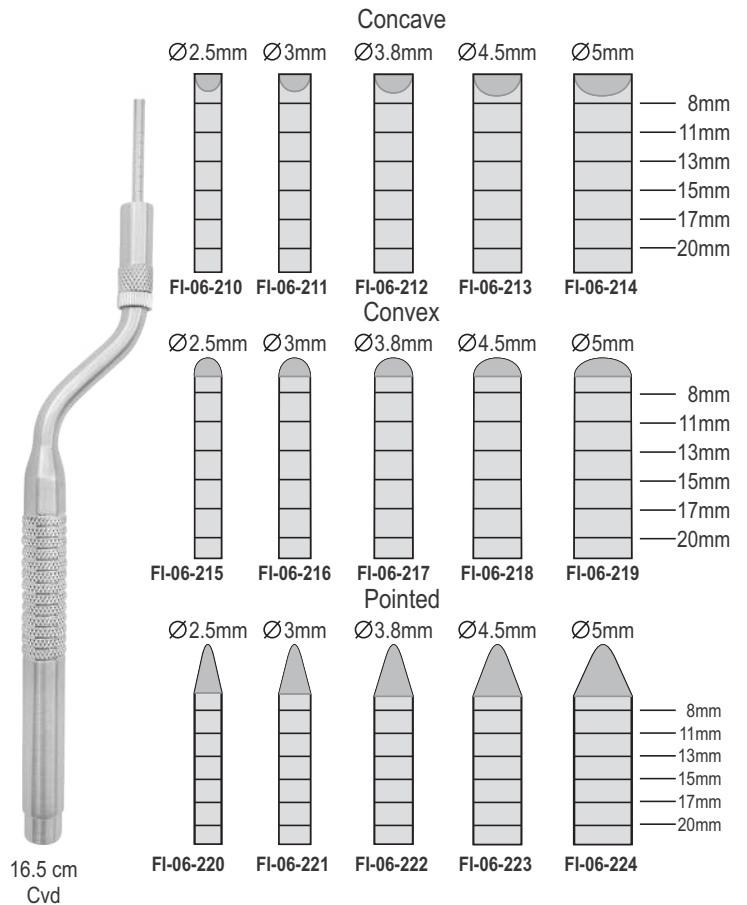
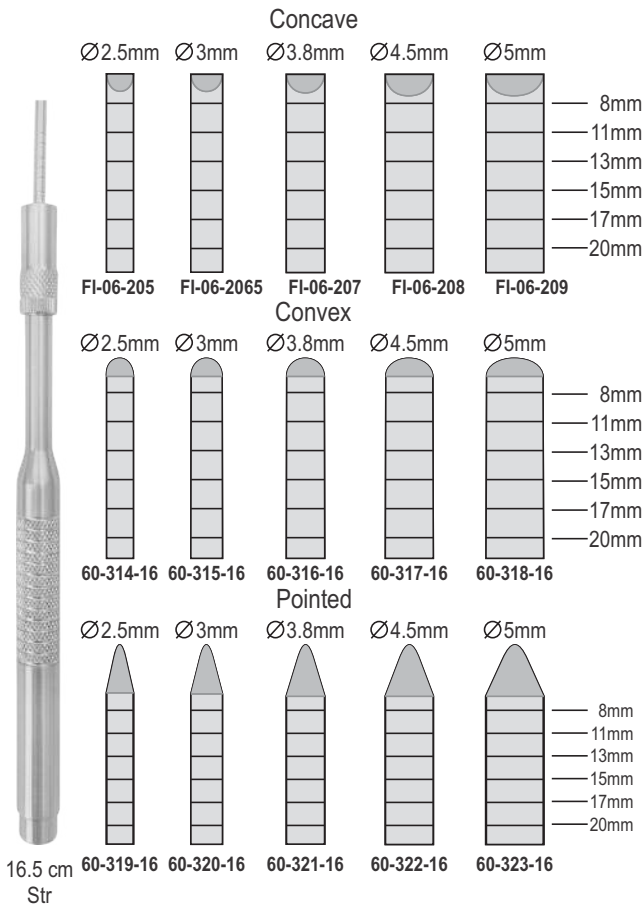
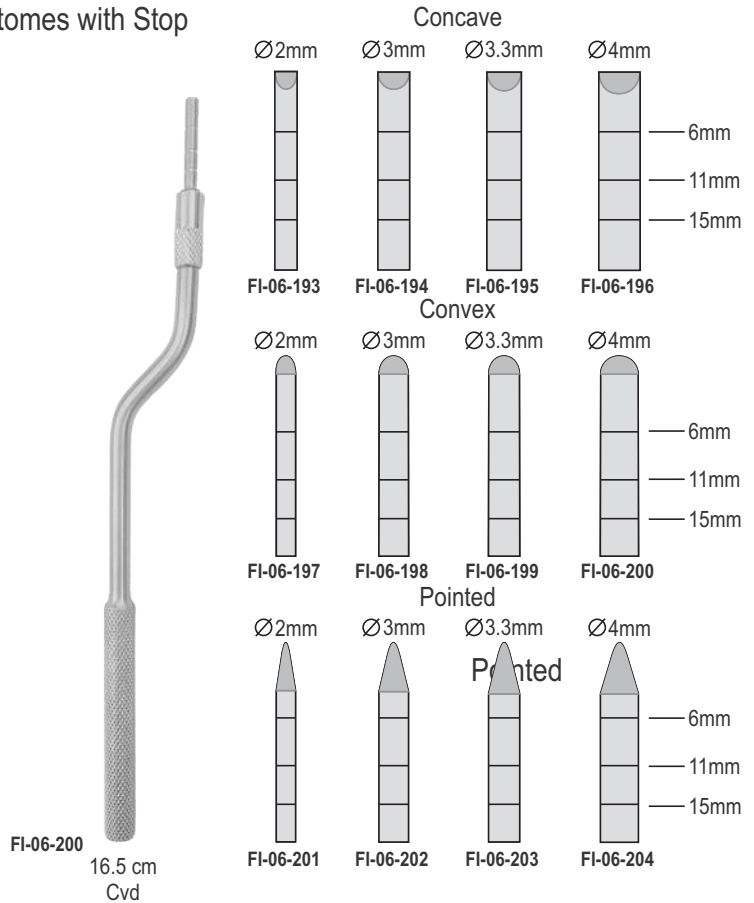
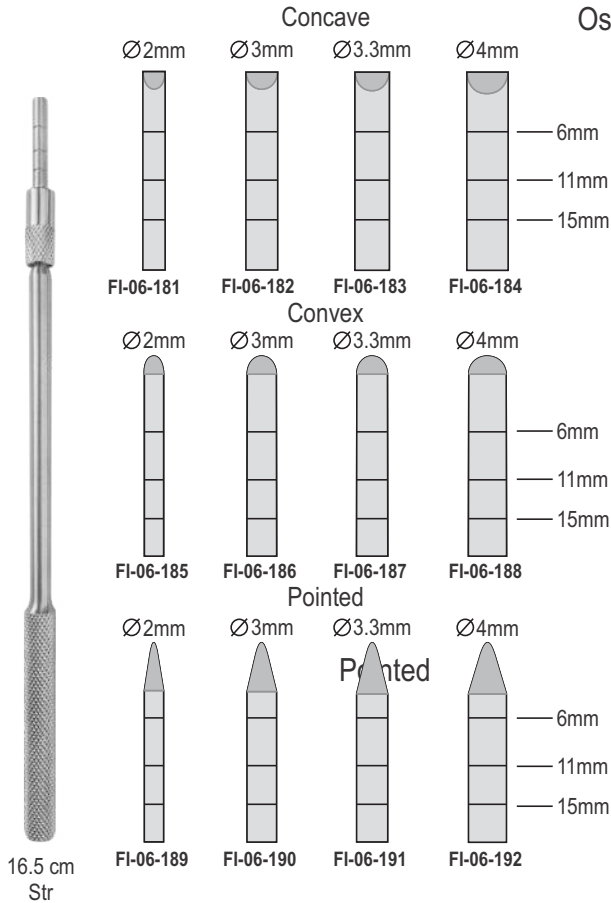
**FI-06-174** **FI-06-175** **FI-06-176** **FI-06-177**



**FI-06-178** **FI-06-179** **FI-06-180**



Osteotomes with Stop



Trephine Drills



**FI-06-225**  
Interior 2 mm  
Exterior 3 mm

**FI-06-226**  
Interior 3 mm  
Exterior 4 mm

**FI-06-227**  
Interior 4 mm  
Exterior 5 mm

**FI-06-228**  
Interior 5 mm  
Exterior 6 mm

**FI-06-229**  
Interior 6 mm  
Exterior 7 mm

**FI-06-230**  
Interior 7 mm  
Exterior 8 mm

**FI-06-231**  
Interior 8 mm  
Exterior 9 mm

**FI-06-232**  
Interior 9 mm  
Exterior 10 mm



**FI-06-233**  
Trephine Drills Stand  
Complete with drills



**FI-06-234**  
Trephine Drills Stand  
Complete with drills

Tissue Punches



**FI-06-235**  
3 mm

**FI-06-236**  
4 mm

**FI-06-237**  
5 mm

**FI-06-238**  
8 mm

Keyes



**FI-06-239**  
3 mm

**FI-06-240**  
4 mm

**FI-06-241**  
5 mm

**FI-06-242**  
6 mm

Keyes

Bone Thickness Gauges



Fig. 1  
Castroviejo  
FI-06-243



Fig. 2  
Castroviejo  
FI-06-244



Fig. 3  
Castroviejo  
FI-06-245



Fig. 4  
Castroviejo  
FI-06-246

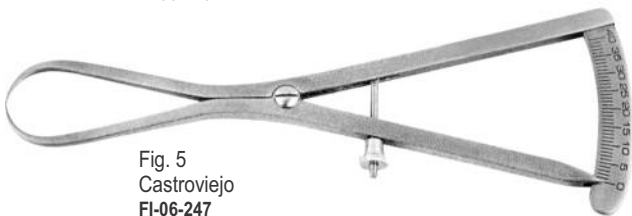


Fig. 5  
Castroviejo  
FI-06-247



FI-06-248  
Bone Thickness Gauge



FI-06-249  
Bone Caliper  
15 cm



60-371-00  
Sinus Rongeur  
Delicate bone cutting forcep  
for opening the sinus window  
4 mm bite, TiN coated

Bone Injectors



Fig. 1  
FI-06-250



Fig. 2  
FI-06-251



Fig. 3  
FI-06-252

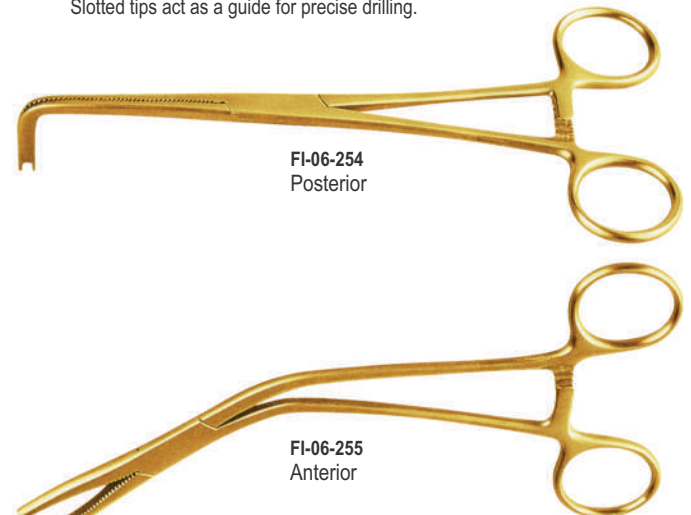


Fig. 4  
FI-06-253



TiN coated bone block clamps

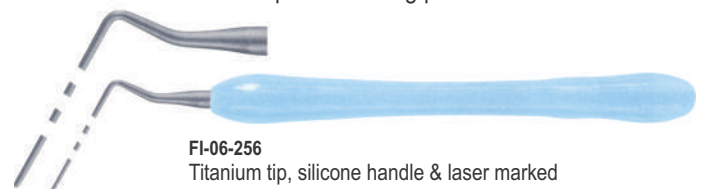
To hold & stabilize block graft against recipient site while placing screws.  
Slotted tips act as a guide for precise drilling.



FI-06-254  
Posterior

FI-06-255  
Anterior

Depth measuring probes



FI-06-256  
Titanium tip, silicone handle & laser marked

Titanium implant periosteal elevators



Fig. 1 FI-06-257 Busar Blue



Fig. 3 FI-06-258 Prichard Blue

Implant periosteal elevators



Fig. 1 FI-06-259 Busar



Fig. 9A FI-06-260 Allen



Fig. 25 FI-06-261 17 cm

Gingivectomy Knives

Hollow handle

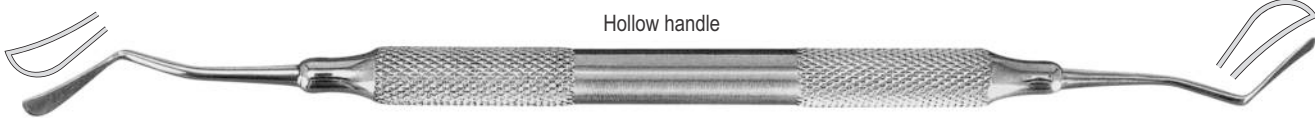


Fig. 15/16 FI-06-262 Kirkland



Fig. 1/2 FI-06-263 Orban

Solid handle



Fig. 15/16 FI-06-264 Kirkland

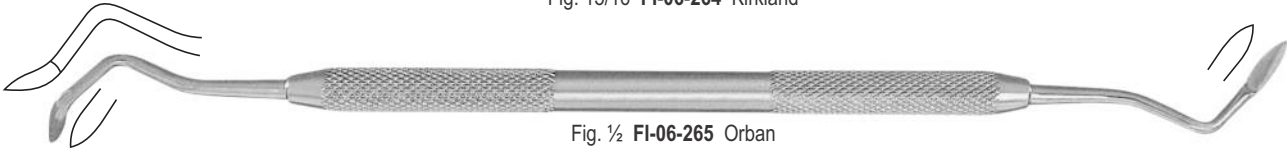


Fig. 1/2 FI-06-265 Orban



Fig. 1 FI-06-266 Orban



Fig. 2 60-382-02 Orban

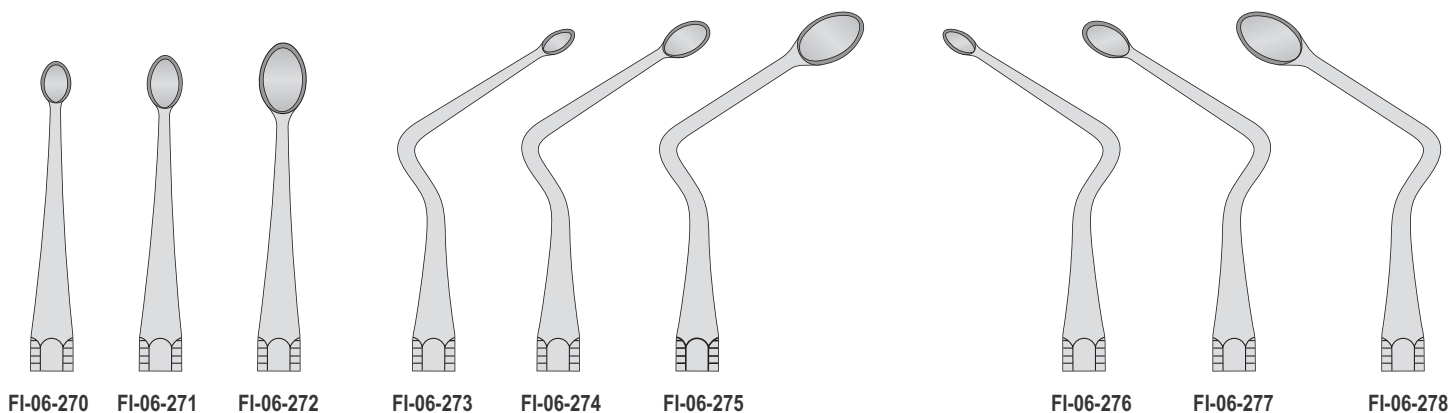
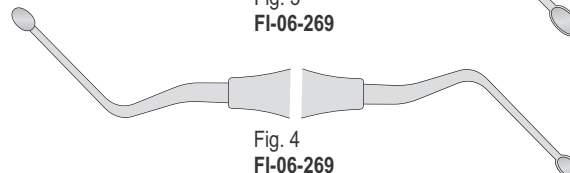
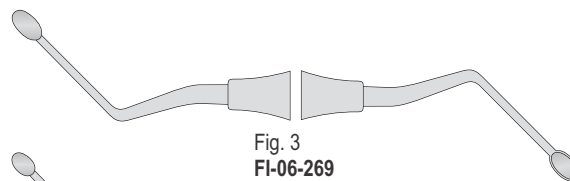
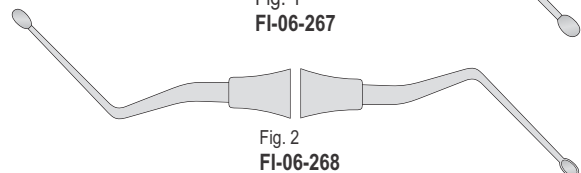
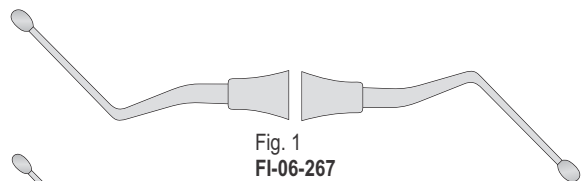
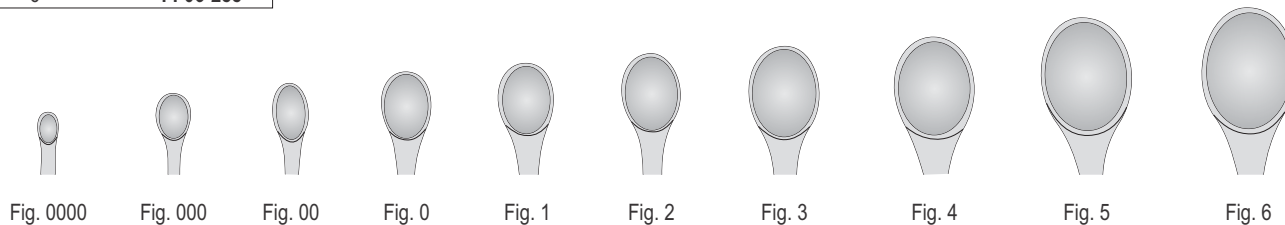
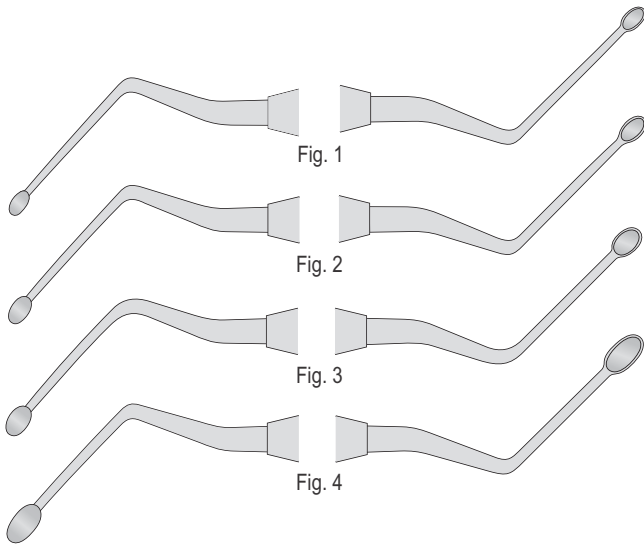
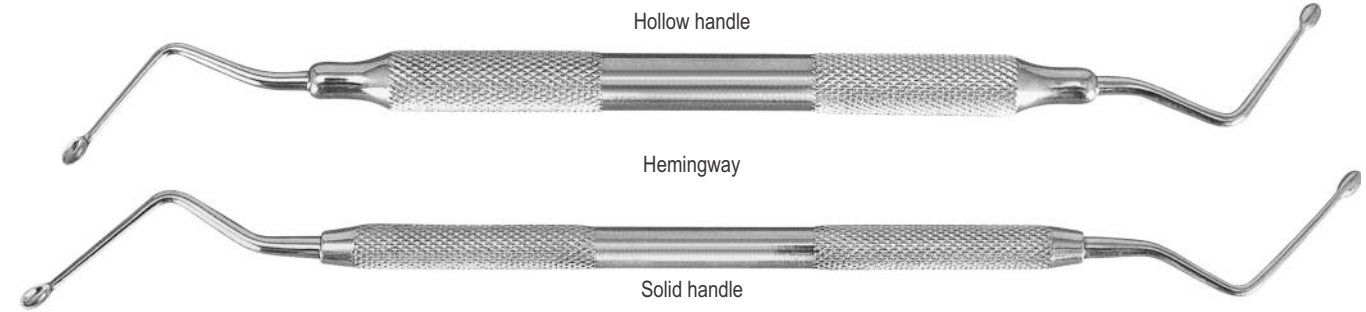
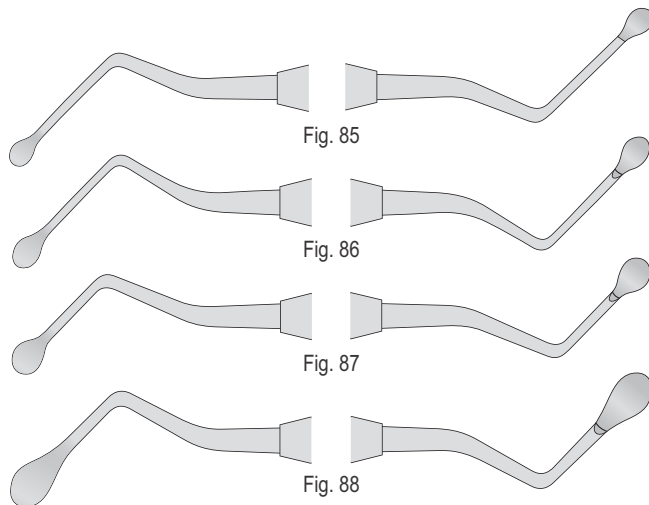
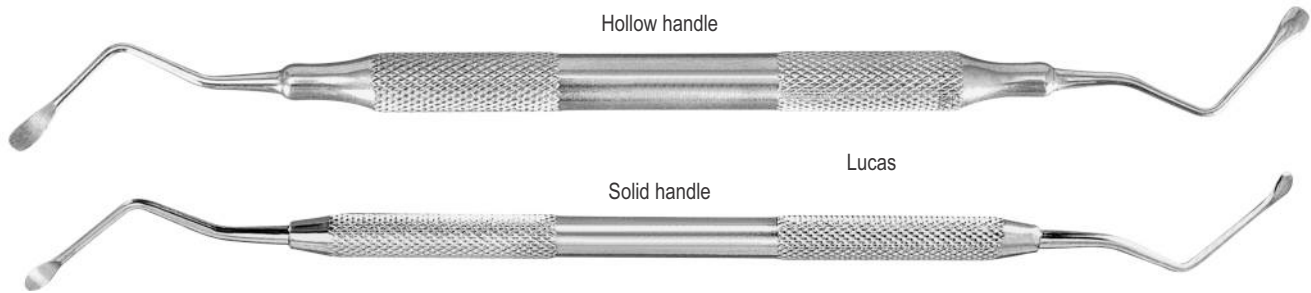


Fig.	Volkman
0000	FI-06-279
000	FI-06-280
00	FI-06-281
0	FI-06-282
1	FI-06-283
2	FI-06-284
3	FI-06-285
4	FI-06-286
5	FI-06-287
6	FI-06-288





	Solid handle	Hollow handle
Fig. 1	FI-06-290	FI-06-294
Fig. 2	FI-06-291	FI-06-295
Fig. 3	FI-06-292	FI-06-296
Fig. 4	FI-06-293	FI-06-297



	Solid handle	Hollow handle
Fig. 85	FI-06-298	FI-06-302
Fig. 86	FI-06-299	FI-06-303
Fig. 87	FI-06-300	FI-06-304
Fig. 88	FI-06-301	FI-06-305

Bone currettes



Molt  
16.5 cm

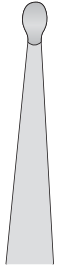


Fig. 1  
FI-06-306

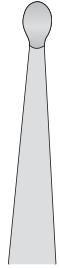


Fig. 2  
FI-06-307

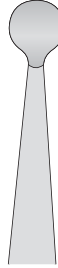


Fig. 4  
FI-06-308

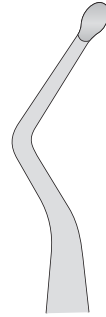


Fig. 5  
FI-06-309



Fig. 6  
FI-06-310

Bone Files



Williger  
14 cm



Fig. 00/0  
FI-06-311



Fig. 0/1  
FI-06-312



Fig. 1/2  
FI-06-313



Bone Files



Fig. 10  
FI-06-314



Fig. 12A  
FI-06-315



Fig. 33  
FI-06-316



Fig. 12  
FI-06-317  
Howard

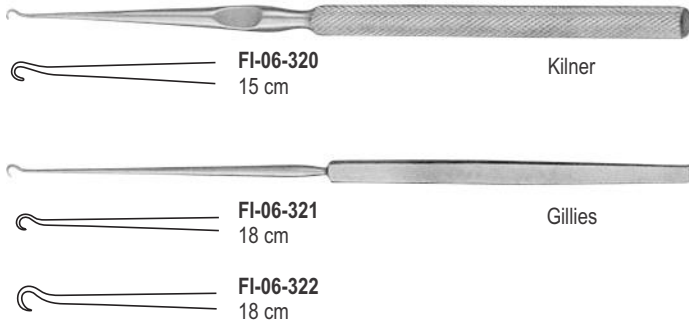


Fig. 45  
FI-06-318  
Miller

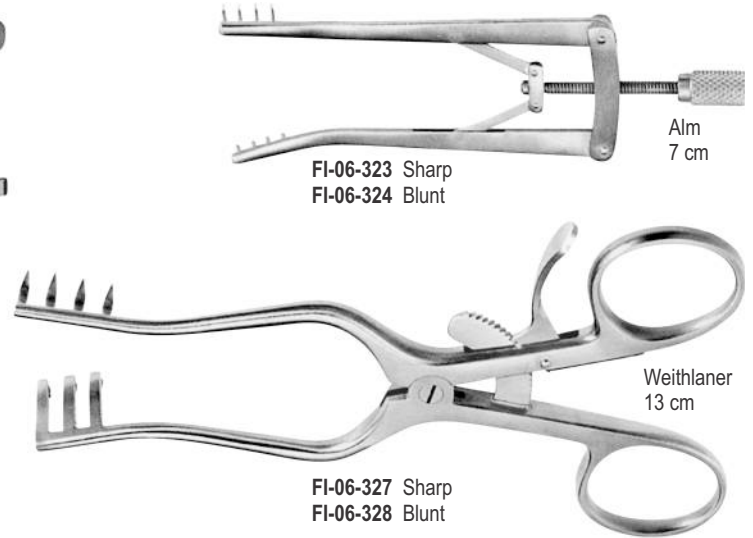


Fig. 64  
FI-06-319  
Miller

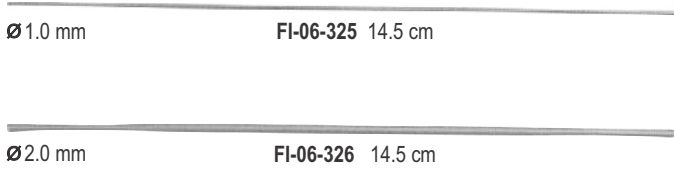
Skin Hooks



Self-Retaining Retractors



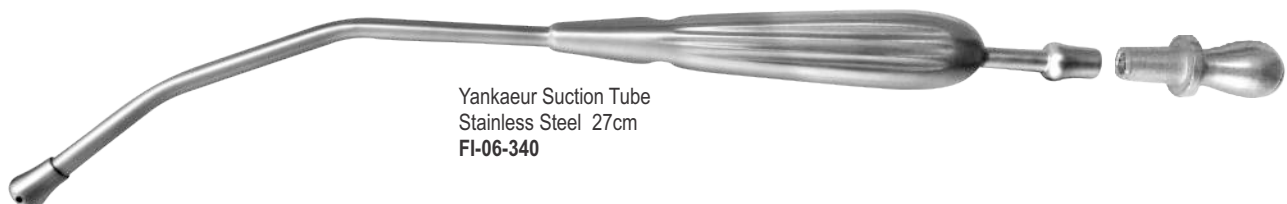
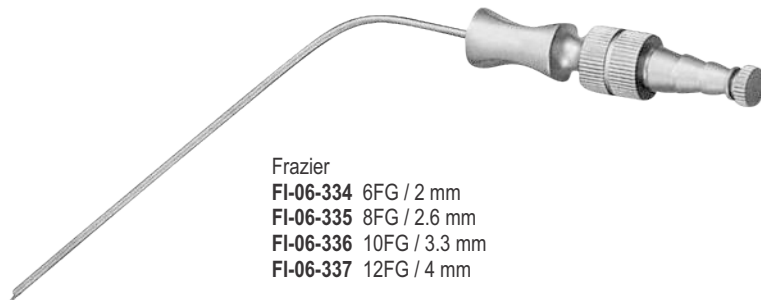
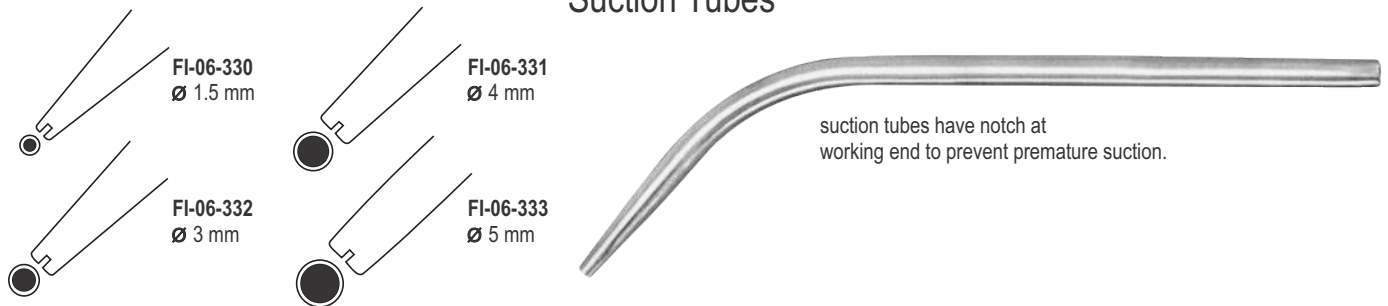
Probes



Suture Forceps



Suction Tubes







07

Page 78-118

## Mirror Handles, Scalers & Knives

Mouth Mirror & Mirror Handles  
Scaler Handles  
Scalpel Blades & Handles  
Micro Scalpel Handles & Blades  
Explorers Double Ended  
Explorers Single Ended  
Probes Single Ended  
Gracey Curettes  
Periodontal Instruments  
Scalers  
Endodontic Instruments  
Filling Instruments  
Cavity Preparation Tips & Amalgam Instruments  
Amalgam Pluggers  
Burnishers  
Composite / Plastic Filling Instruments  
Excavators  
Carvers & Finishing Knives  
Finishing Knives & Cleoid-Discoid  
Wax Modelling Carvers  
Cement Spatulae & Glass Mixing Slabs  
Plaster Knives - Alginate & Plaster Spatulae  
Wax Knives



Fig. 4  
**FI-07-001**  
Ø 22 mm

Fig. 5  
**FI-07-002**  
Ø 24 mm

Fig. 000  
**FI-07-003**  
Ø 10 mm

Fig. 00  
**FI-07-004**  
Ø 12 mm

- Rhodium coated front surface mirror
  - Wide stem offers comfortable cheek retraction
  - Non glare satin finish
- Micro mirrors  
Rhodium front surface

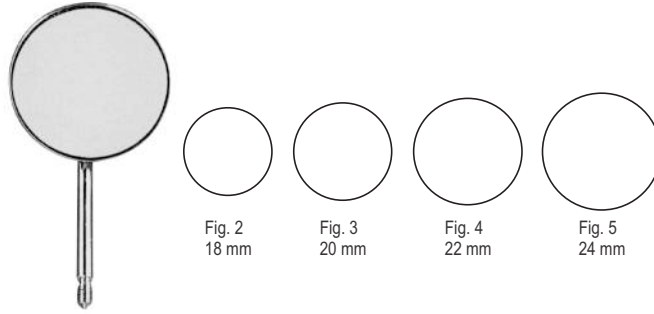


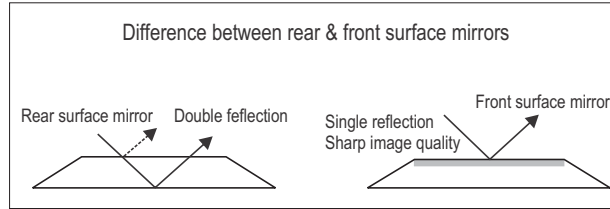
Fig. 2  
18 mm

Fig. 3  
20 mm

Fig. 4  
22 mm

Fig. 5  
24 mm

Fig.	Ø mm	Pack of 12			
		Front surface		Rear surface	
		Rhodium	Chrome	Magnifying	Plane
2	18	<b>FI-07-005</b>	-	<b>FI-07-011</b>	<b>FI-07-015</b>
3	20	<b>FI-07-006</b>	-	<b>FI-07-012</b>	<b>FI-07-016</b>
4	22	<b>FI-07-007</b>	<b>FI-07-009</b>	<b>FI-07-013</b>	<b>FI-07-017</b>
5	24	<b>FI-07-008</b>	<b>FI-07-010</b>	<b>FI-07-014</b>	<b>FI-07-018</b>



### Mirror handles solid



Fig. 1  
**FI-07-019**

Fig. 2  
**FI-07-020**

Fig. 3  
**FI-07-021**

Fig. 4  
**FI-07-022**

### Mirror handles hollow

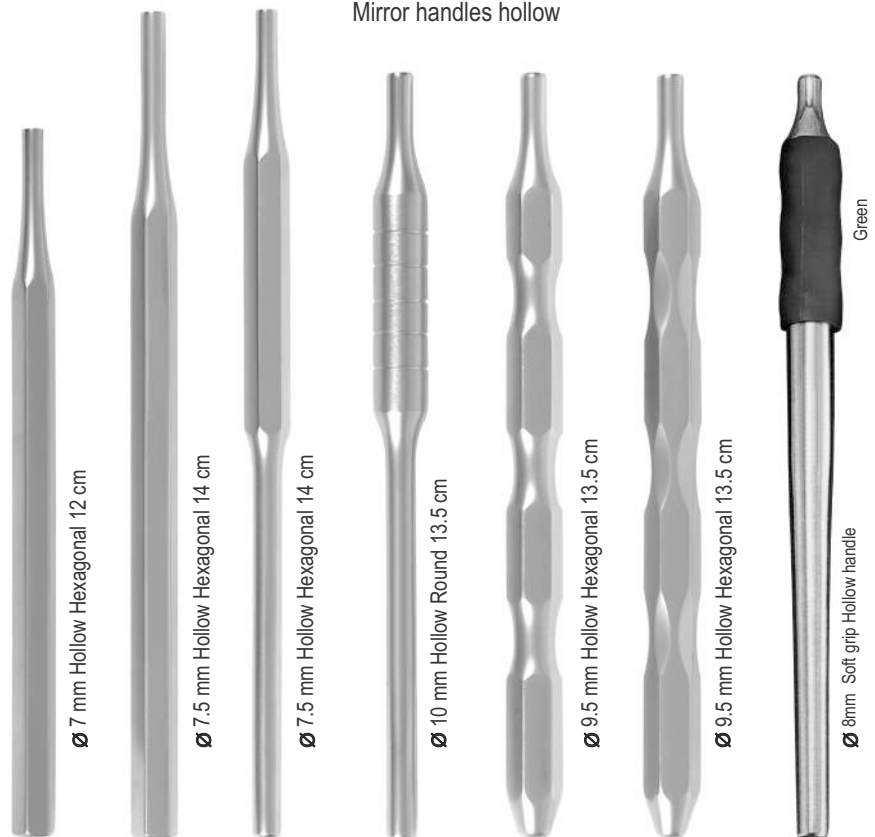


Fig. 1  
**FI-07-023**

Fig. 2  
**FI-07-024**

Fig. 3  
**FI-07-025**

Fig. 4  
**FI-07-026**

Fig. 5  
**FI-07-027**

Fig. 6  
**FI-07-028**

Fig. 7  
**FI-07-029**

Ø 7 mm Hollow Hexagonal 12 cm

Ø 7.5 mm Hollow Hexagonal 14 cm

Ø 7.5 mm Hollow Hexagonal 14 cm

Ø 10 mm Hollow Round 13.5 cm

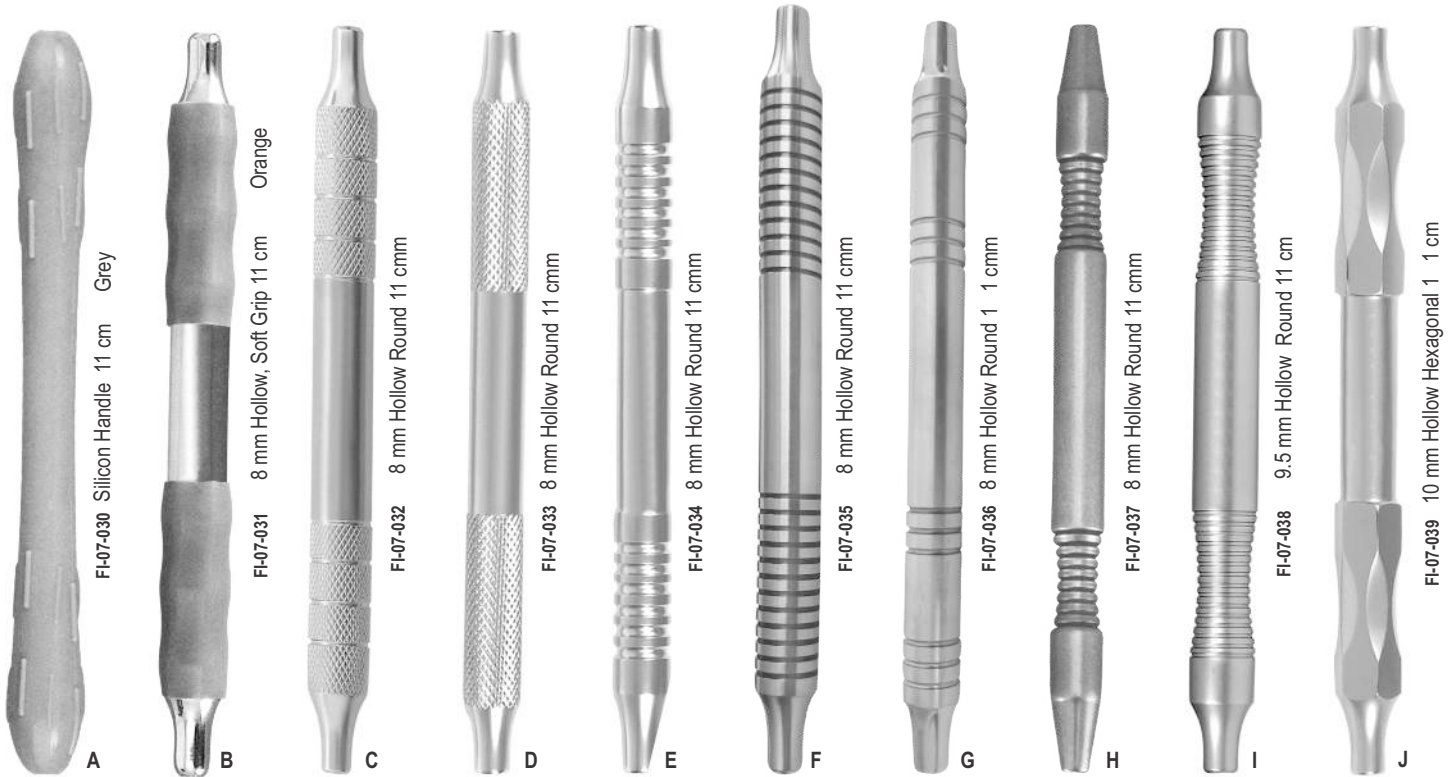
Ø 9.5 mm Hollow Hexagonal 13.5 cm

Ø 9.5 mm Hollow Hexagonal 13.5 cm

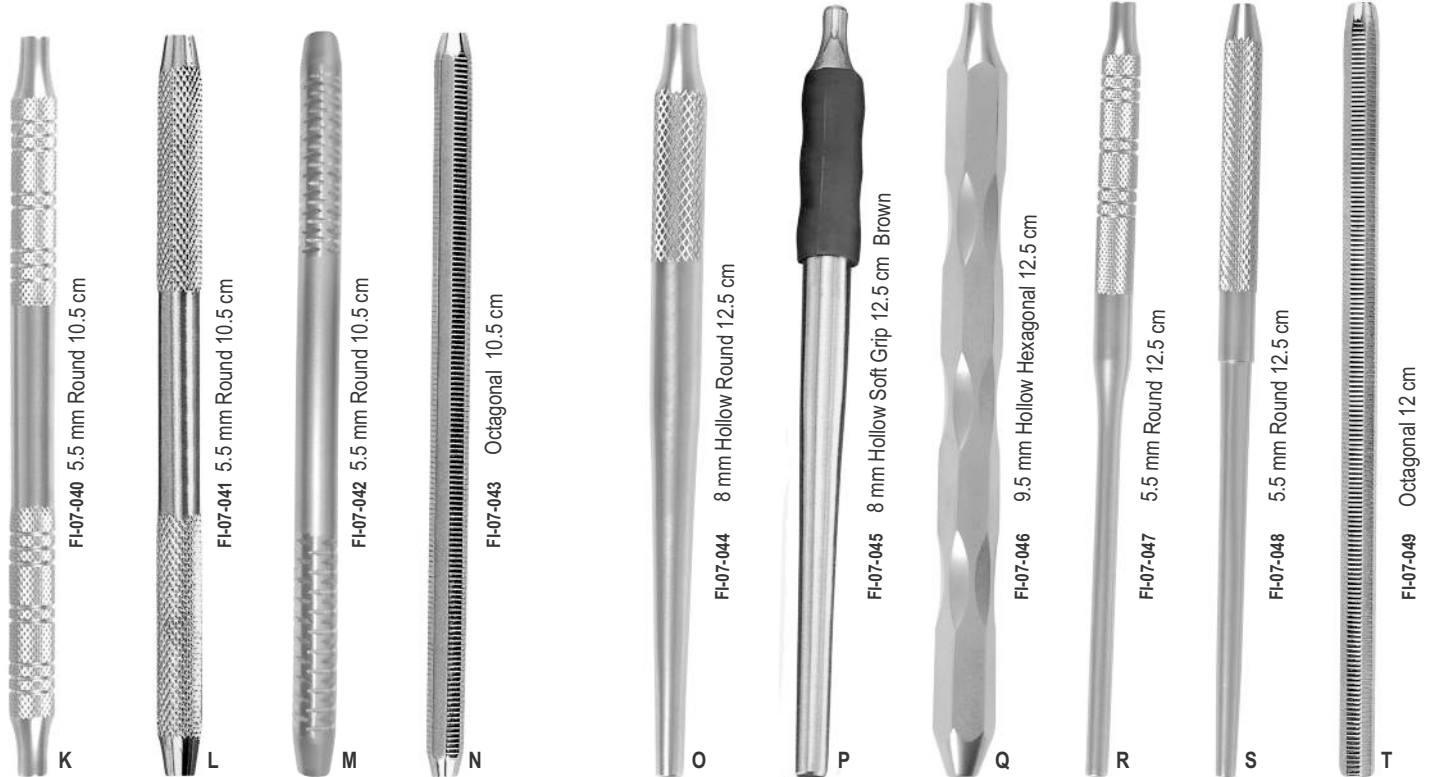
Ø 8mm Soft grip Hollow handle

Green

Double Ended



Double Ended



Single Ended

- Sterile
- Individually Packed
- Box of 100 Pieces



Fig. 10 FI-07-050    Fig. 11 FI-07-051    Fig. 12 FI-07-052    Fig. 12D FI-07-053    Fig. 13 FI-07-054    Fig. 15 FI-07-055    Fig. 15C FI-07-056    Fig. 20 FI-07-057    Fig. 21 FI-07-058    Fig. 22 FI-07-059    Fig. 23 FI-07-060    Fig. 24 FI-07-061    Fig. 25 FI-07-062



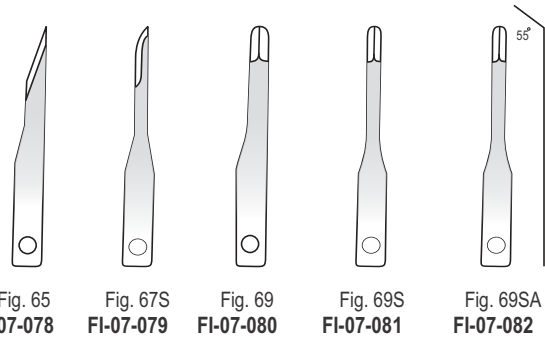
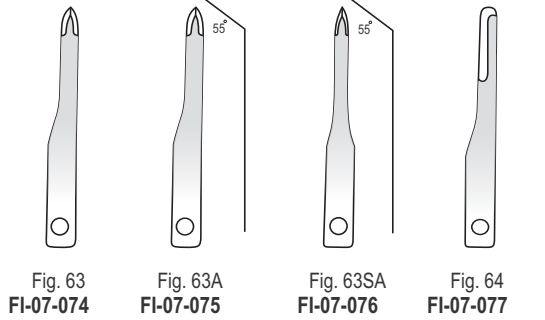
For scalpel No. 10, 11, 12, 12D, 13, 15, 15C

For Blades No. 20, 21, 22, 23, 24, 25

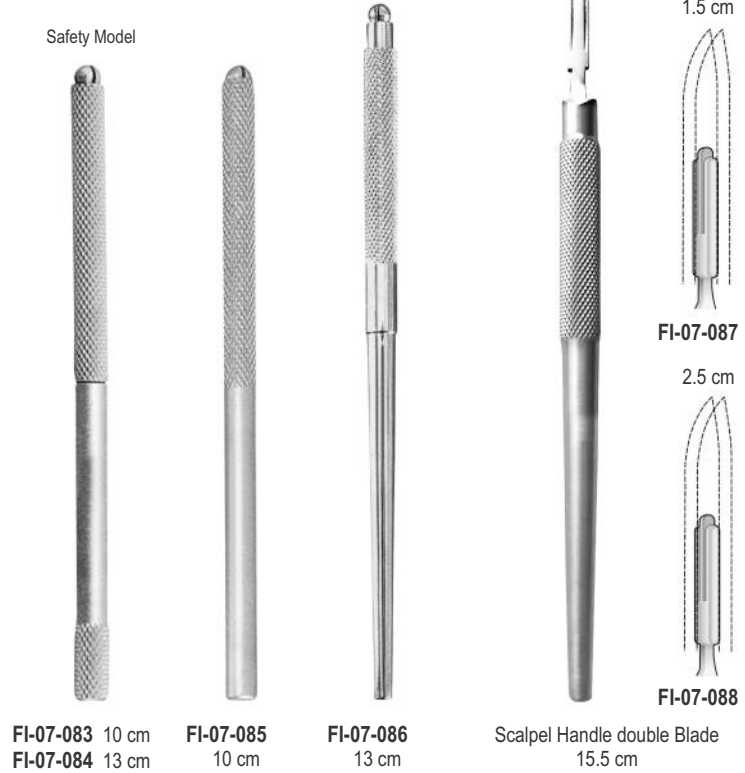
Red

Fig. 3 FI-07-063    Fig. 3G FI-07-064    Fig. 4 FI-07-065    Fig. 3L FI-07-066    Fig. 7K FI-07-067    Fig. 7 FI-07-068    50-130-01 FI-07-069    Fig. 5S FI-07-070    Fig. 5A FI-07-071    Fig. 5 FI-07-072    Fig. 5 FI-07-073

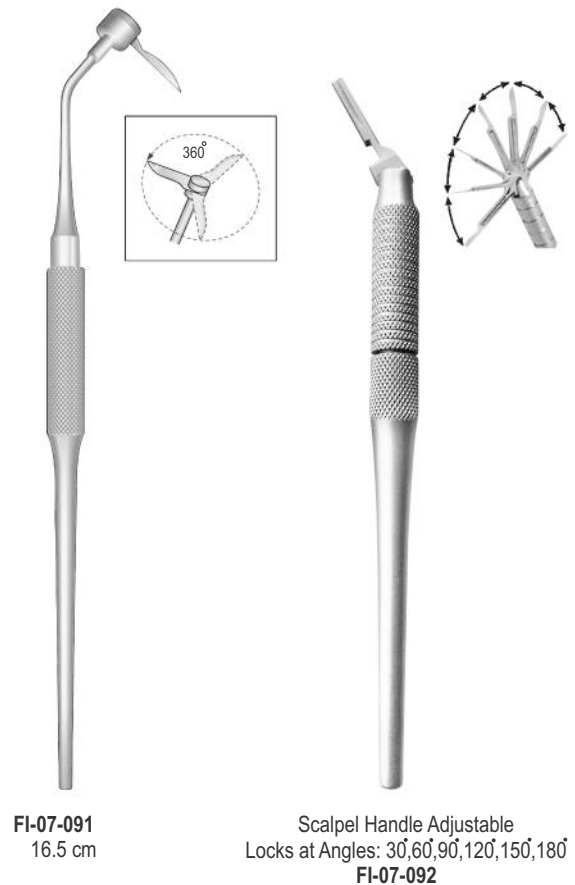
Micro scalpel & micro mirror handles



Safety Model



Scalpel Blade removing Forceps



## Explorers double ended rigid



Fig. 23/17 FI-07-093



Fig. 23/17A FI-07-094

## Explorers double ended rigid



Fig. 23/17 FI-07-094



Fig. 23/17A FI-07-095



Fig. 23/16 FI-07-096

## Explorers double ended Flexible



Fig. 2 FI-07-097

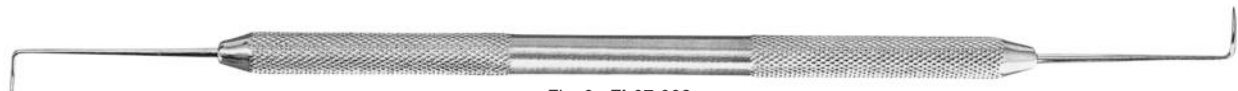


Fig. 3 FI-07-098



Fig. 5 FI-07-099

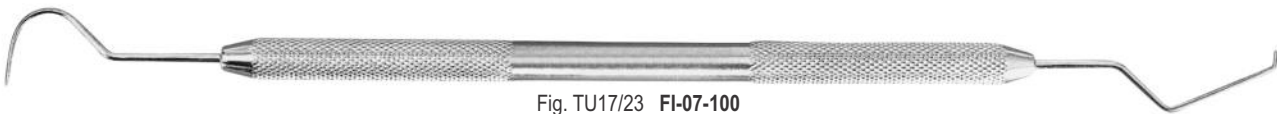


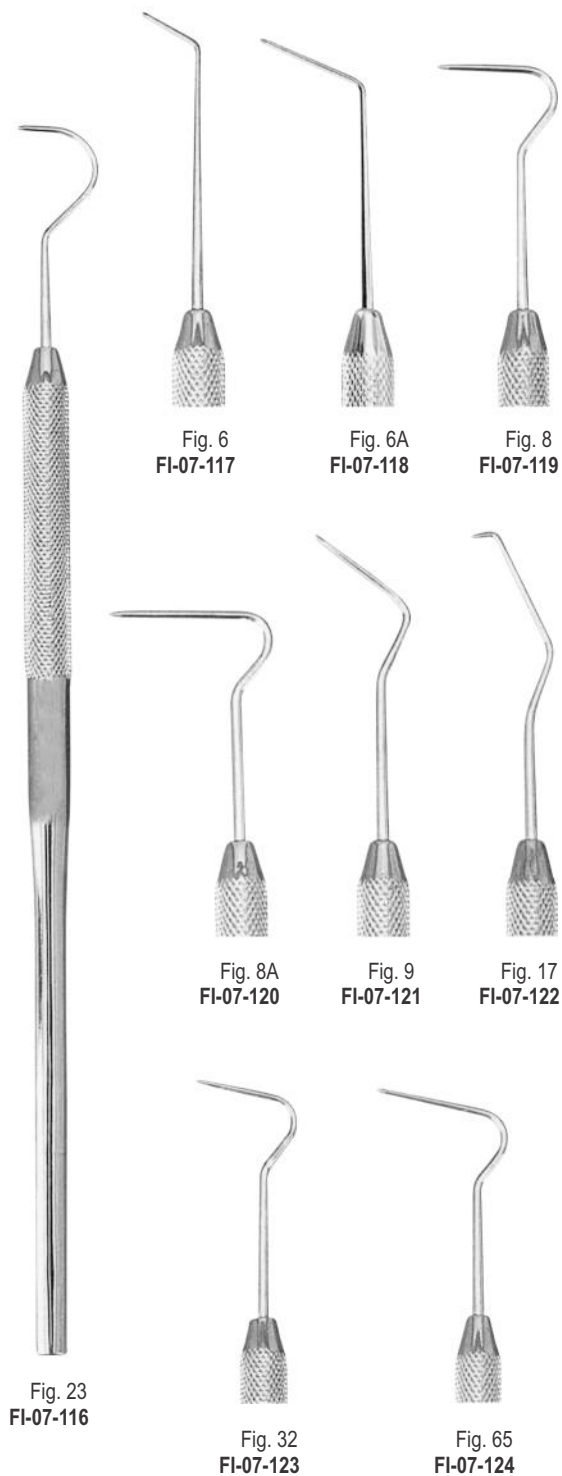
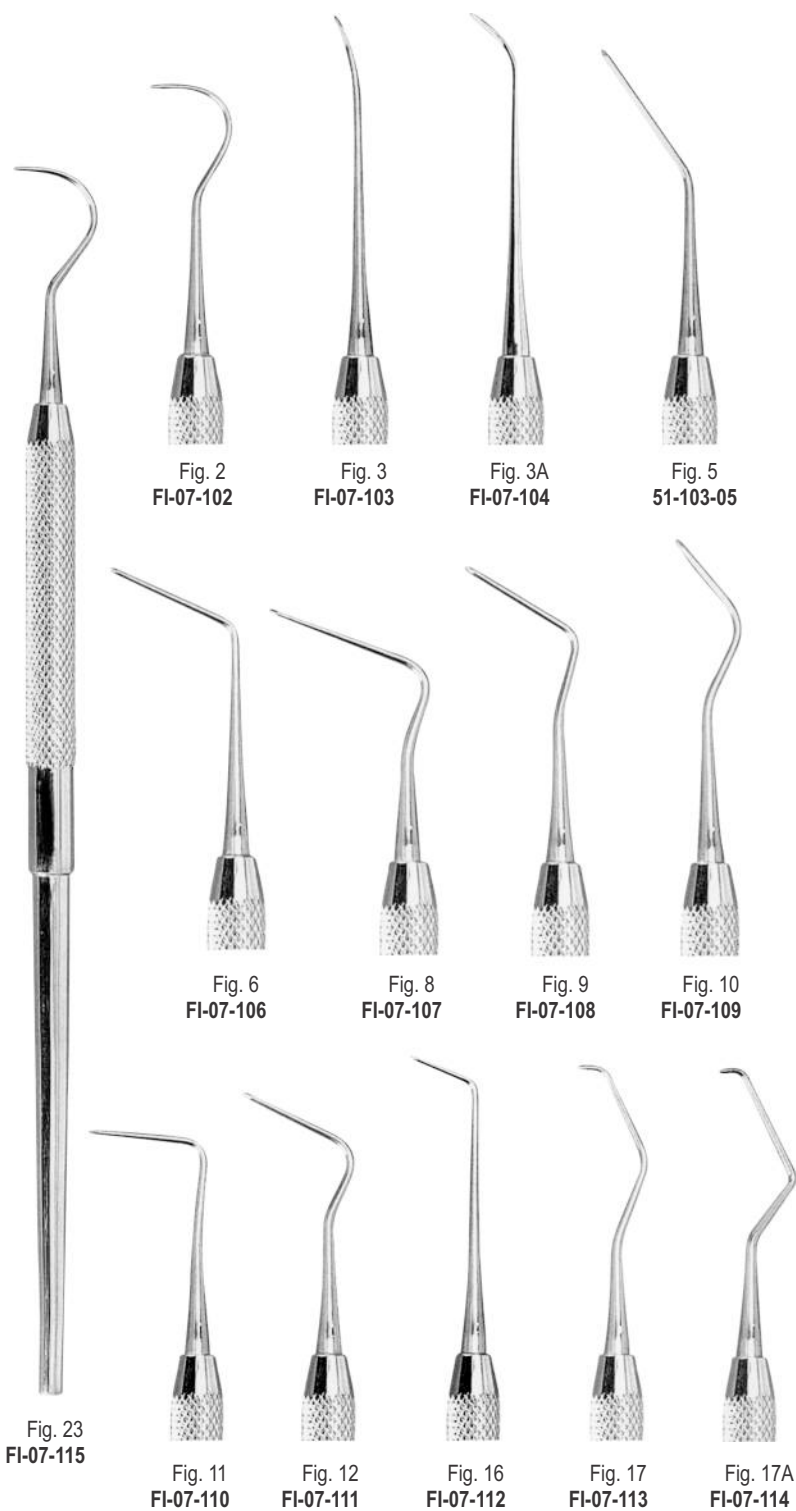
Fig. TU17/23 FI-07-100



Fig. 6/23 FI-07-101

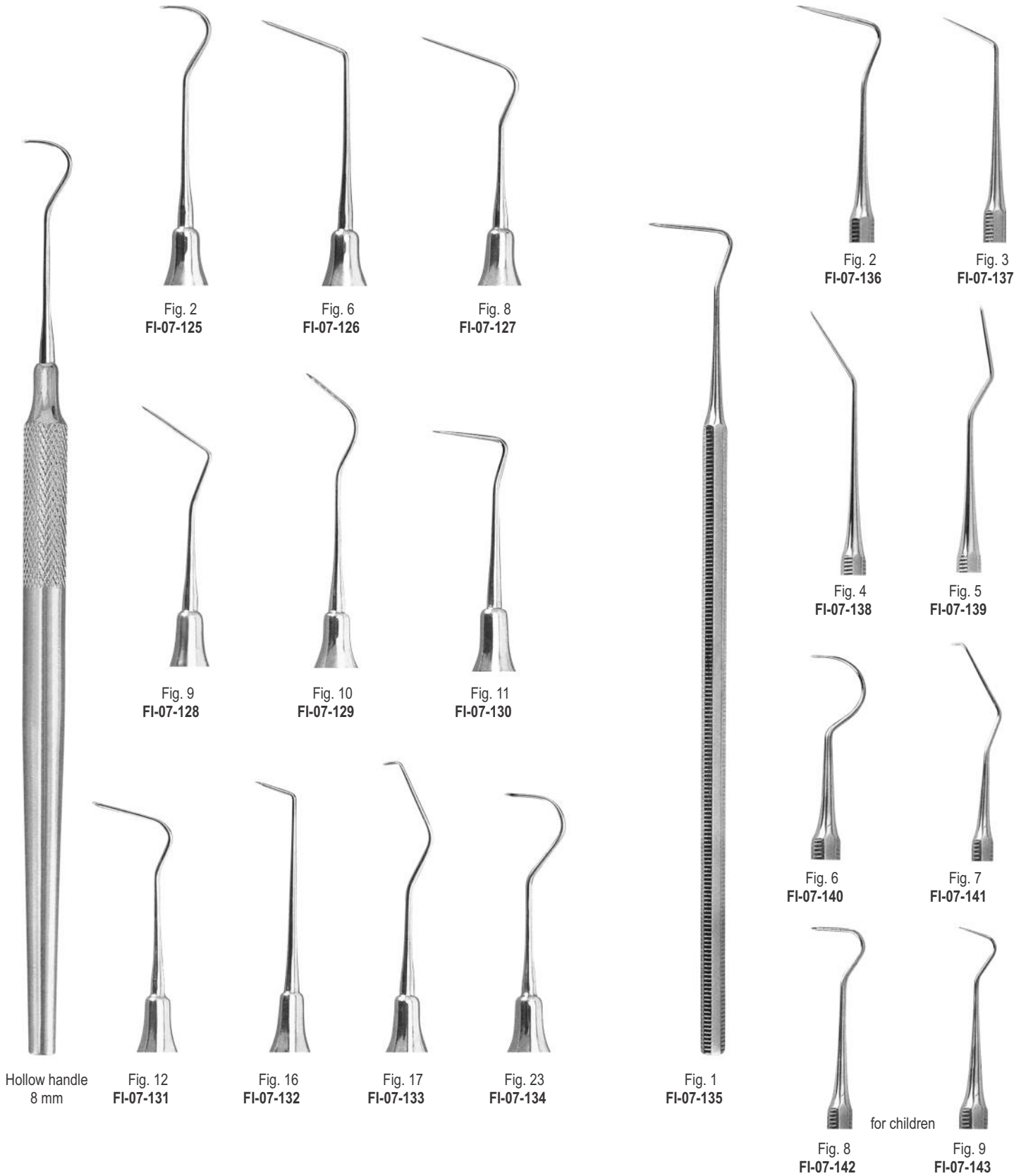
Explorers single ended rigid

Explorers single ended flexible



Explorers single ended rigid

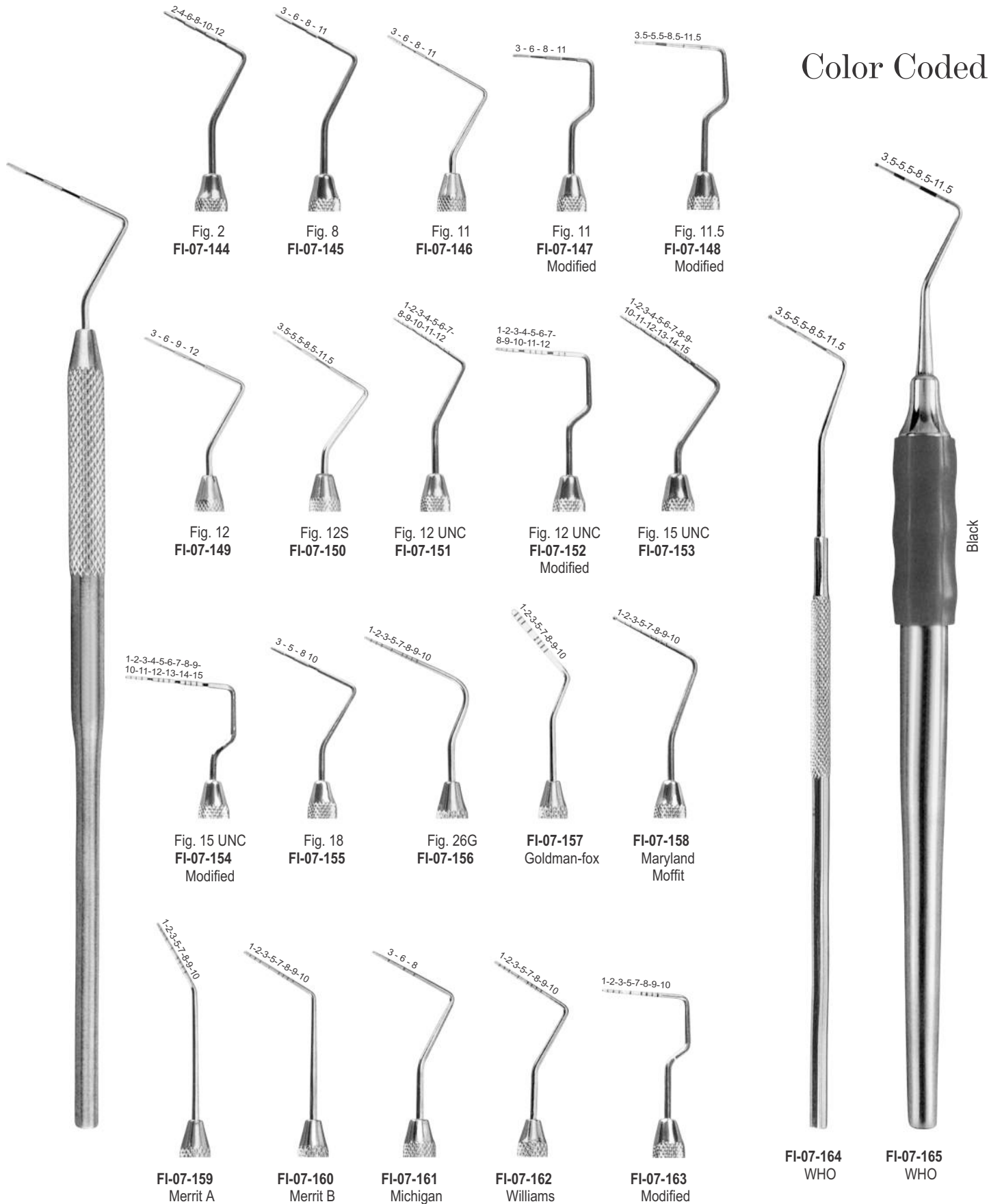
Explorers single ended rigid





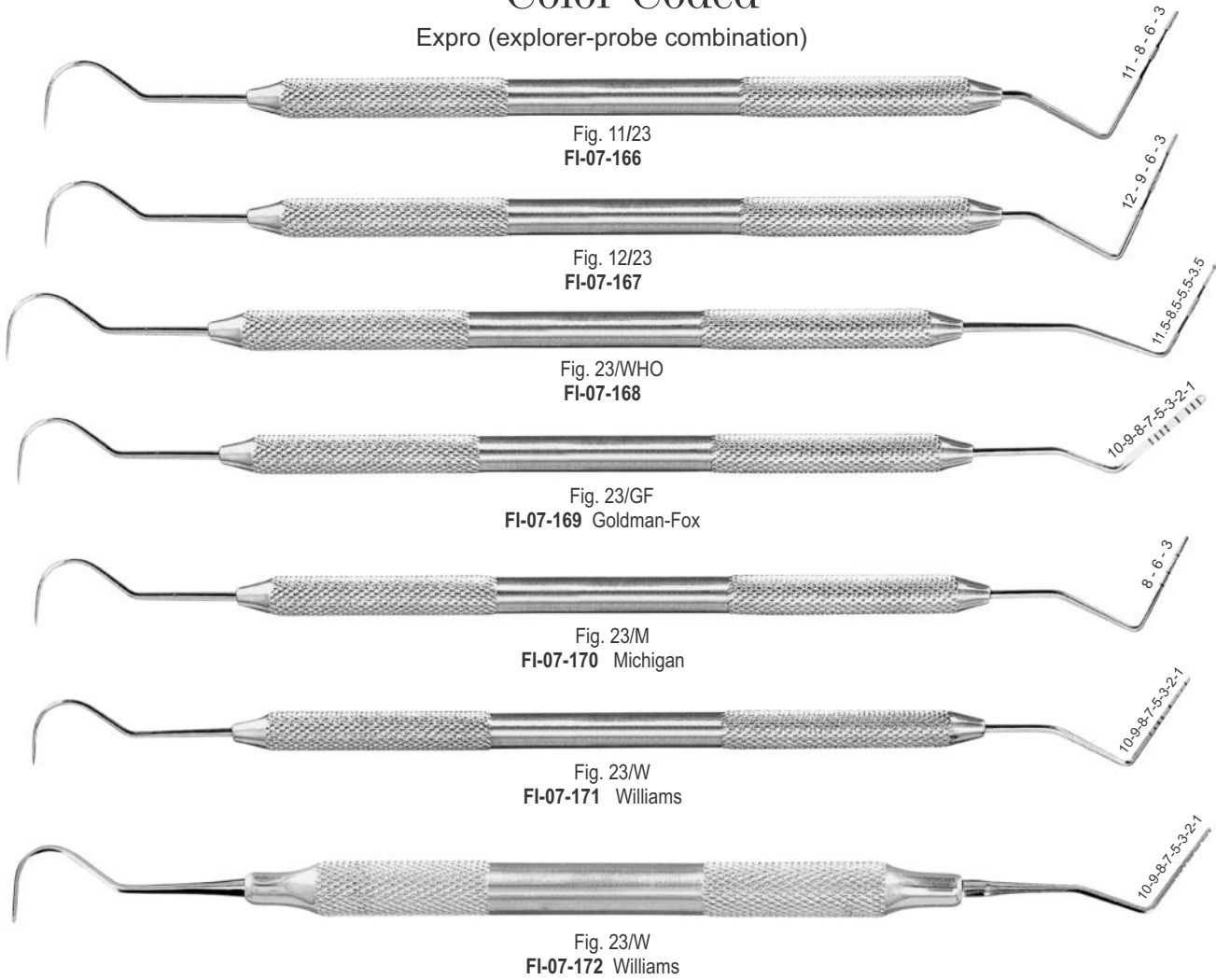
PROBES SINGLE ENDED  
SONDE A TERMINAZIONE SINGOLA

Color Coded

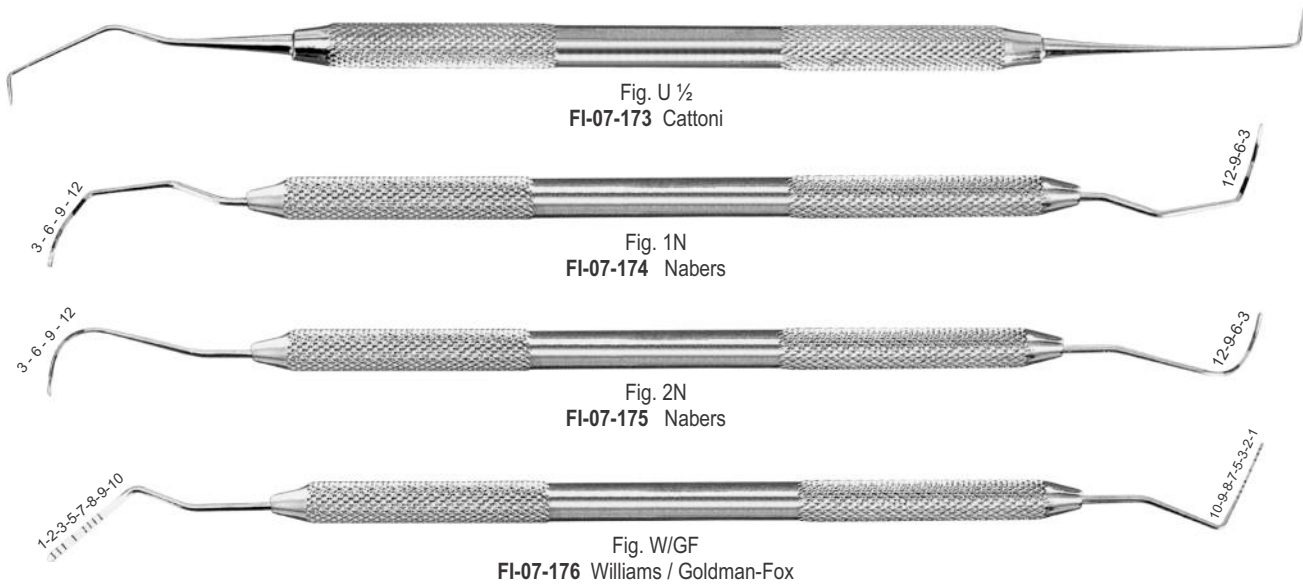


**Color Coded**

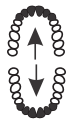
Expro (explorer-probe combination)



Probes double ended



- Ergonomic, large diameter silicone handle for better grip
- Ultra light weight
- Special grade stainless steel tips ensure longer life
- Rigid pattern, thicker tips than standard Gracey

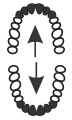


Anterior teeth



Grey

Fig. 1/2  
FI-07-177 Rigid  
FI-07-185 Standard

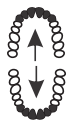


Anterior teeth



Black

Fig. 3/4  
FI-07-178 Rigid  
FI-07-186 Standard

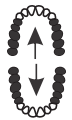


Anterior and Premolars



Yellow

Fig. 5/6  
FI-07-179 Rigid  
FI-07-187 Standard

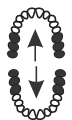


Premolars and Molars



Green

Fig. 7/8  
FI-07-180 Rigid  
FI-07-188 Standard

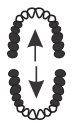


Molars buccal and lingual surfaces



Red

Fig. 9/10  
FI-07-181 Rigid  
FI-07-189 Standard

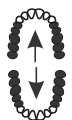


Posterior Mesial surfaces



Orange

Fig. 11/12  
FI-07-182 Rigid  
FI-07-190 Standard



Posterior distal surfaces



Blue

Fig. 13/14  
FI-07-183 Rigid  
FI-07-191 Standard

FI-07-177  
Set of 7 pieces / Rigid

FI-07-184  
Set of 7 pieces / Standard



Fig. 3/4  
**FI-07-193**  
Black  
Anterior teeth



Fig. 5/6  
**FI-07-194**  
Yellow  
Anterior and Premolars



Fig. 7/8  
**FI-07-195**  
Grey  
Premolars and Molars



Fig. 9/10  
**FI-07-196**  
Red  
Molars buccal and lingual surfaces



Fig. 11/12  
**FI-07-197**  
Orange  
Posterior mesial surfaces

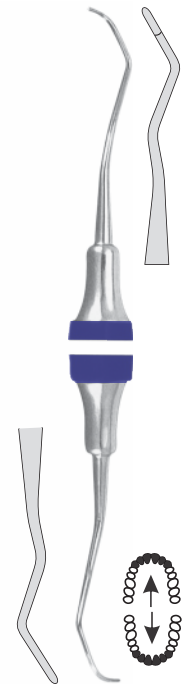


Fig. 13/14  
**FI-07-198**  
Blue  
Posterior distal surfaces

**FI-07-199**  
Set of 7 pieces  
Fig. 1/2, 3/4, 5/6, 7/8, 9/10, 11/12, 13/14

Fig. 1/2  
**FI-07-192**  
Green  
Anterior teeth



Fig. 15/16  
**FI-07-200**  
Coffee  
Posterior mesial surfaces

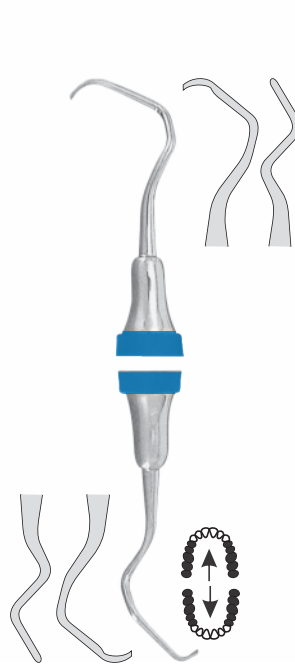


Fig. 17/18  
**FI-07-201**  
Light Blue  
Posterior distal surfaces

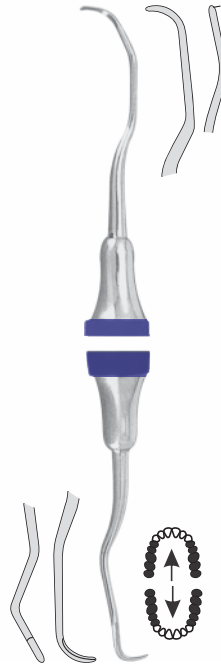


Fig. 11/14  
**FI-07-202**  
Blue  
Mesial/Distal surfaces

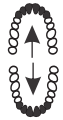


Fig. 12/13  
**FI-07-203**  
Orange  
Mesial/Distal surfaces

Solid handle



Hollow handle



Anterior teeth

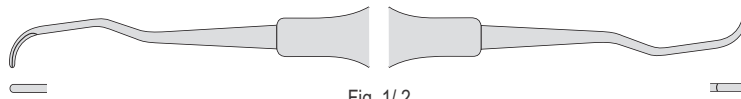
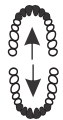


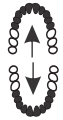
Fig. 1/2



Anterior teeth



Fig. 3/4



Anterior and  
Premolars

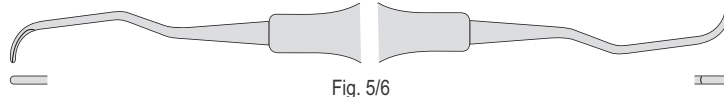


Fig. 5/6



Premolars and  
Molars

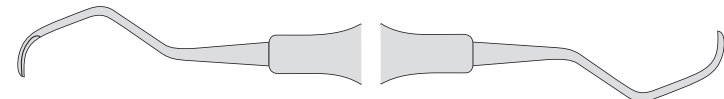
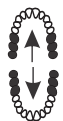


Fig. 7/8



Molars buccal and  
lingual surfaces

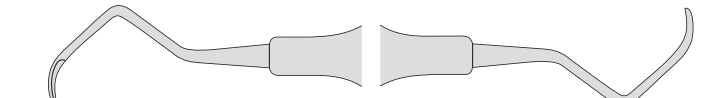
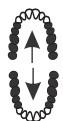


Fig. 9/10



Posterior mesial  
surfaces

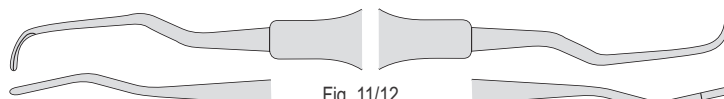


Fig. 11/12



Posterior distal  
surfaces

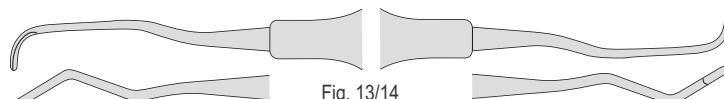


Fig. 13/14

	Solid handle
Fig. 1/2	<b>FI-07-204</b>
Fig. 3/4	<b>FI-07-205</b>
Fig. 5/6	<b>FI-07-206</b>
Fig. 7/8	<b>FI-07-207</b>
Fig. 9/10	<b>FI-07-208</b>
Fig. 11/12	<b>FI-07-209</b>
Fig. 13/14	<b>FI-07-210</b>

**FI-07-211**  
Gracey set of 7 pieces

	Hollow handle
Fig. 1/2	<b>FI-07-212</b>
Fig. 3/4	<b>FI-07-213</b>
Fig. 5/6	<b>FI-07-214</b>
Fig. 7/8	<b>FI-07-215</b>
Fig. 9/10	<b>FI-07-216</b>
Fig. 11/12	<b>FI-07-217</b>
Fig. 13/14	<b>FI-07-218</b>

**FI-07-219**  
Gracey set of 7 pieces

Periodontal chisels



Fig. 1 FI-07-220 TG



Fig. 2 FI-07-221 TG

Universal Curettes Columbia

Solid handle



Hollow handle



			Solid handle	Hollow handle
	Universal	Fig. 13/14	FI-07-222	FI-07-223
	Anterior teeth	Fig. 2R/2L	FI-07-224	FI-07-225
	Posterior teeth	Fig. 4R/4L	FI-07-226	FI-07-227

Hoe scalars

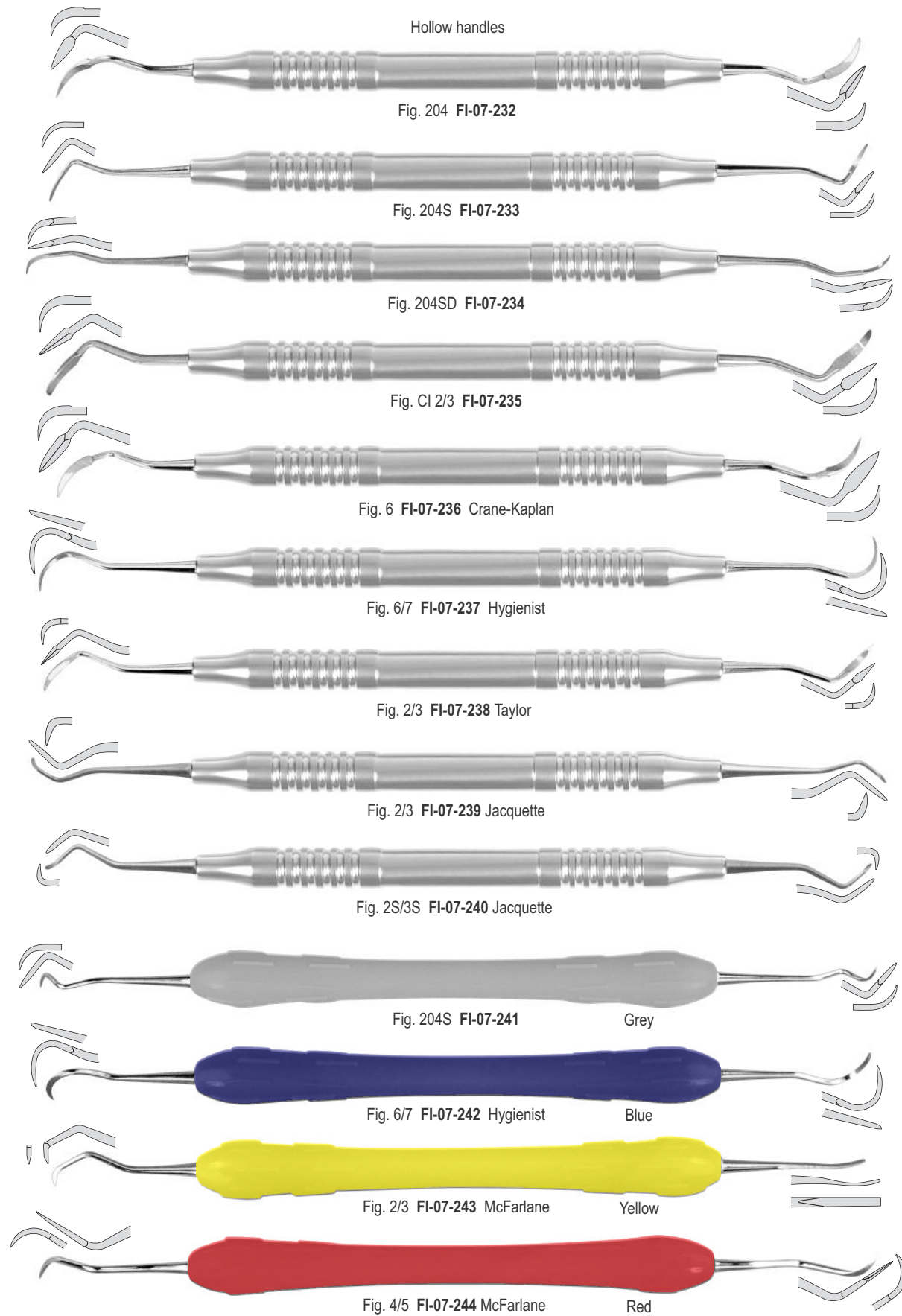
Solid handle



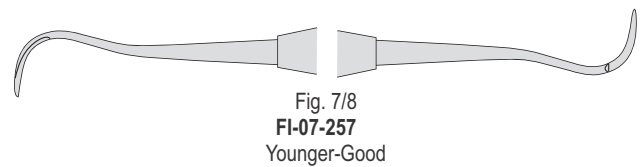
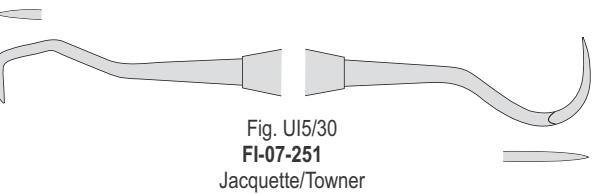
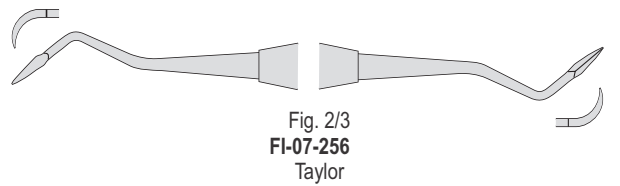
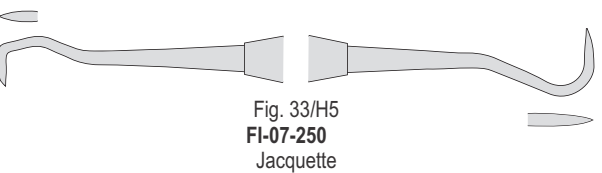
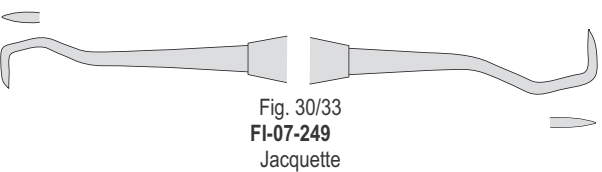
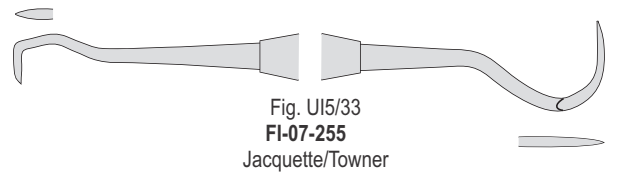
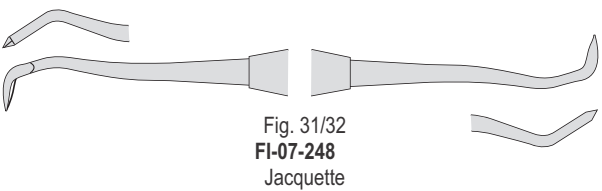
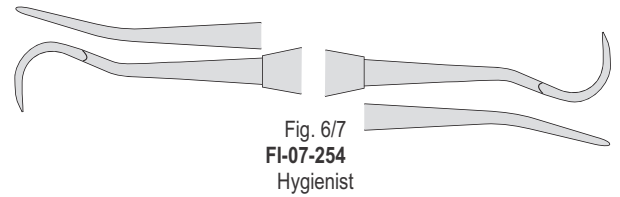
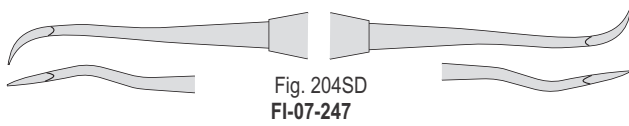
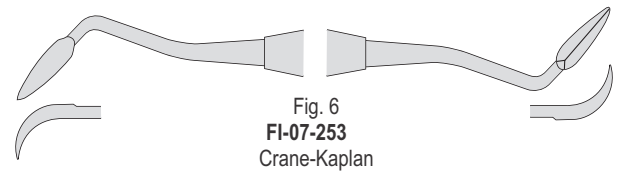
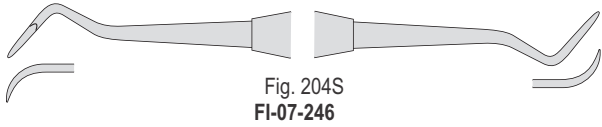
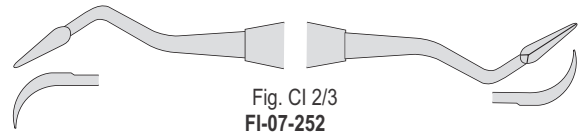
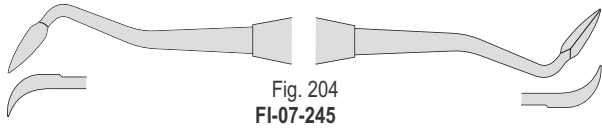
Hollow handle



		Solid handle	Hollow handle
	Goldman-Fox		
Fig. 5		FI-07-227	FI-07-229
Fig. 6		FI-07-230	FI-07-231



Solid handle





Hollow handle

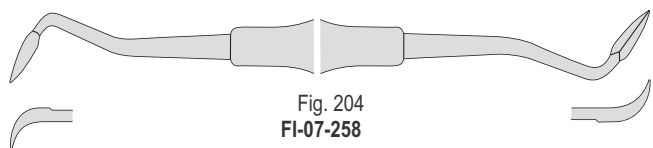
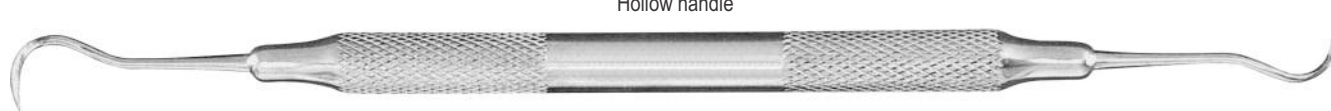


Fig. 204  
FI-07-258

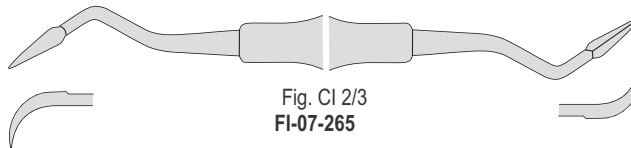


Fig. CI 2/3  
FI-07-265

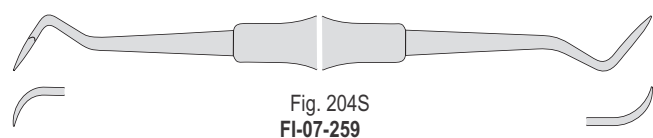


Fig. 204S  
FI-07-259

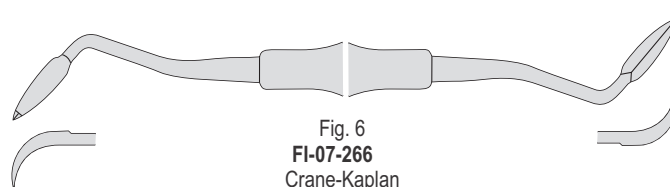


Fig. 6  
FI-07-266  
Crane-Kaplan

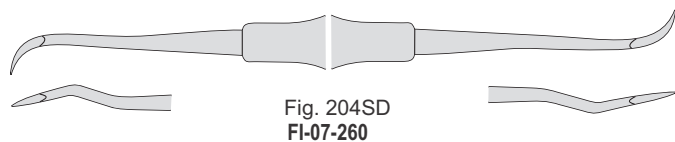


Fig. 204SD  
FI-07-260

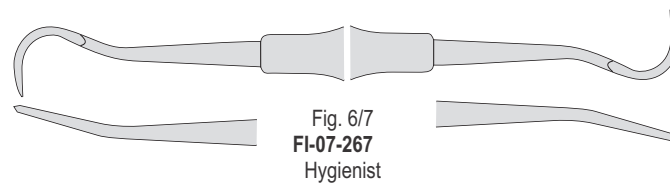


Fig. 6/7  
FI-07-267  
Hygienist

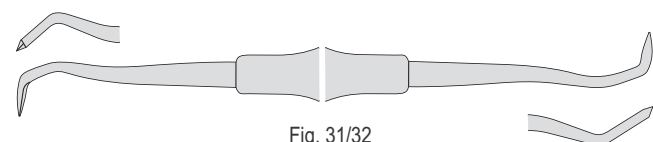


Fig. 31/32  
FI-07-261  
Jacquette

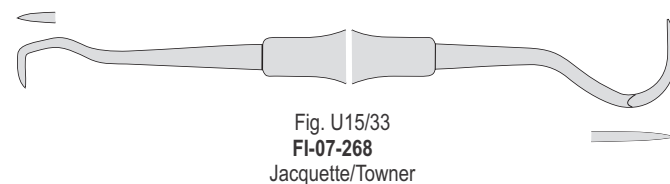


Fig. U15/33  
FI-07-268  
Jacquette/Towner

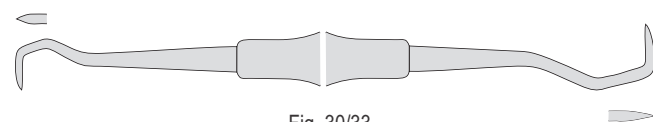


Fig. 30/33  
FI-07-262  
Jacquette

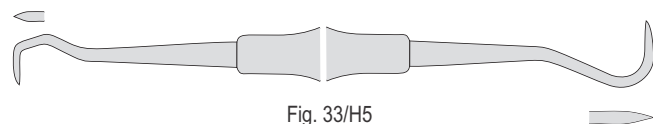


Fig. 33/H5  
FI-07-263  
Jacquette

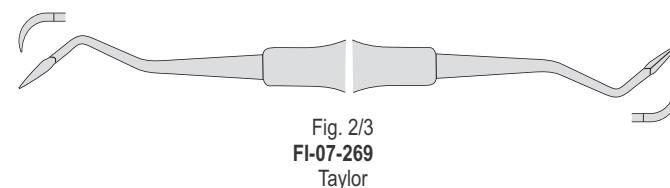


Fig. 2/3  
FI-07-269  
Taylor

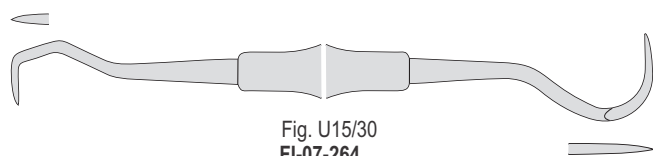


Fig. U15/30  
FI-07-264  
Jacquette/Towner

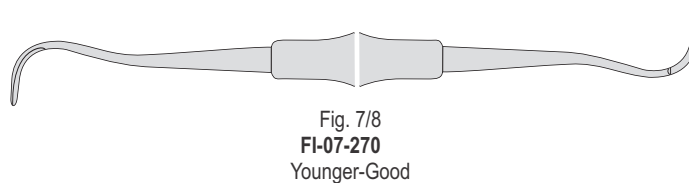
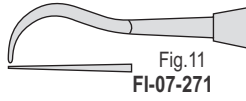


Fig. 7/8  
FI-07-270  
Younger-Good

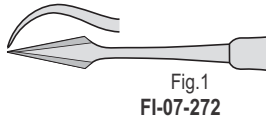
Solid Handle



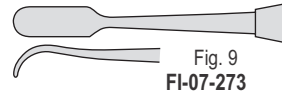
Darby Perry



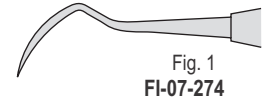
Standard



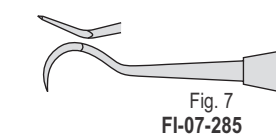
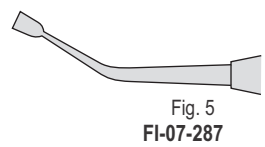
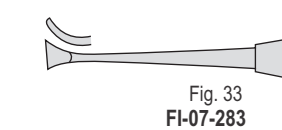
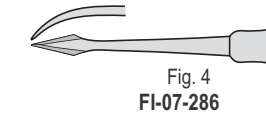
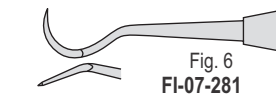
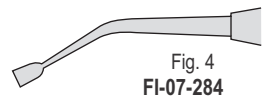
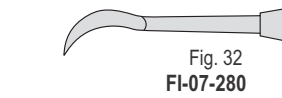
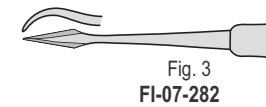
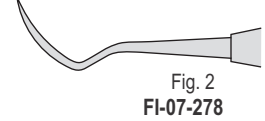
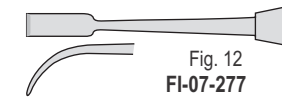
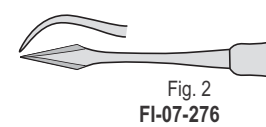
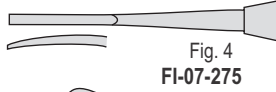
Standard



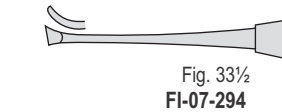
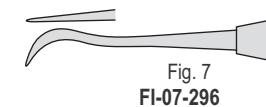
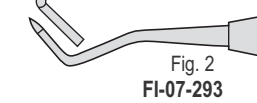
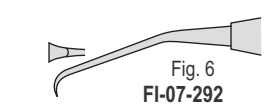
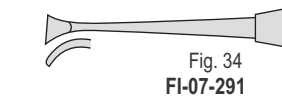
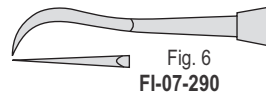
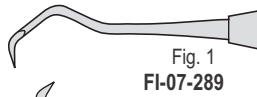
MRU Palma



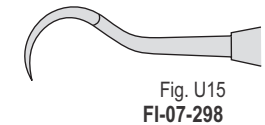
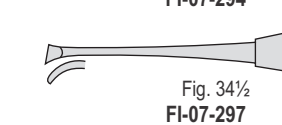
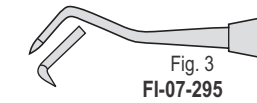
Hygienist



Jacquette



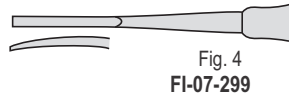
Towner



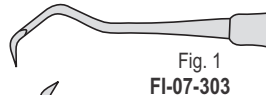
Hollow Handle 8mm



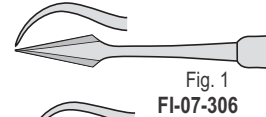
Hygienist



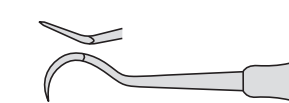
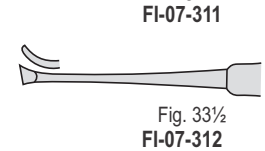
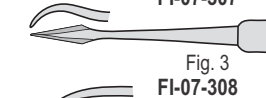
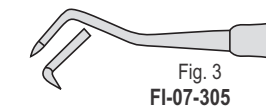
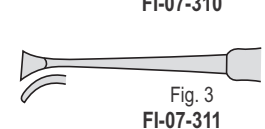
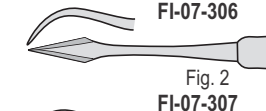
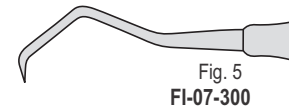
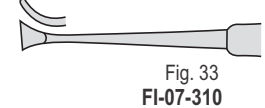
Jacquette



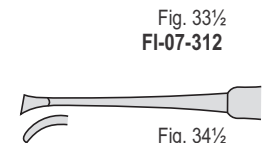
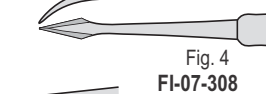
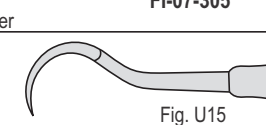
Standard



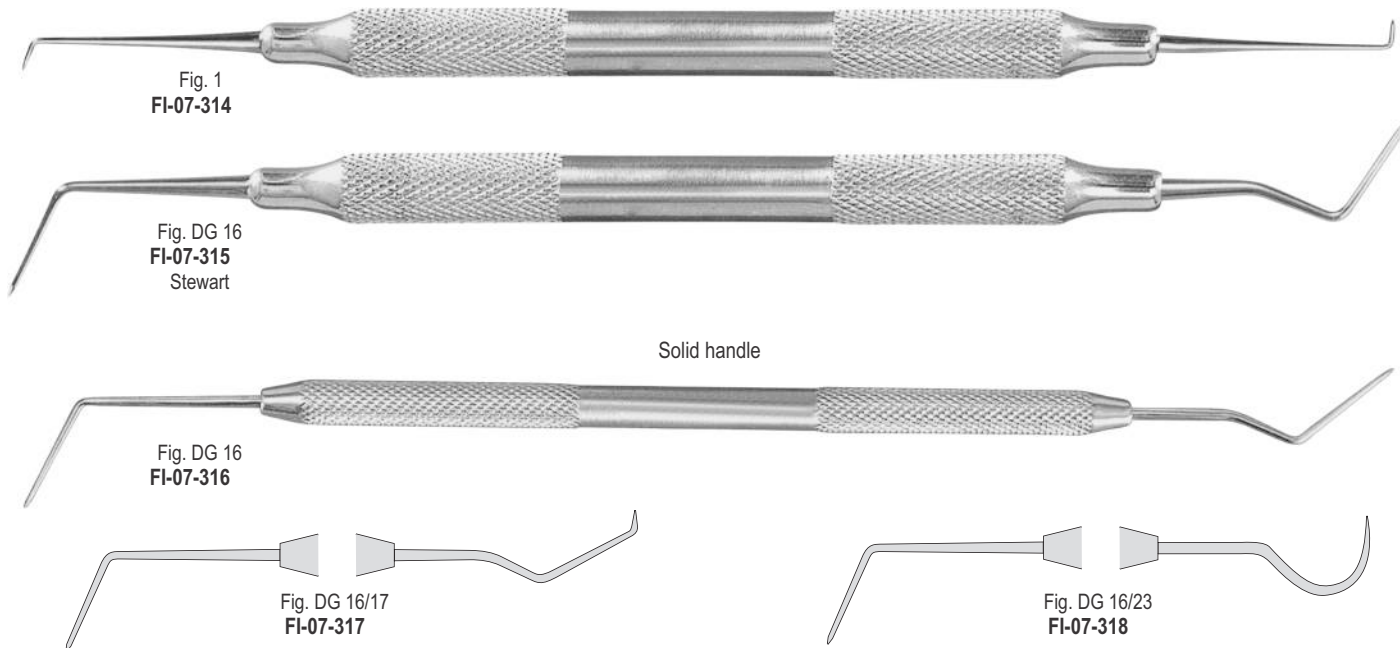
Standard



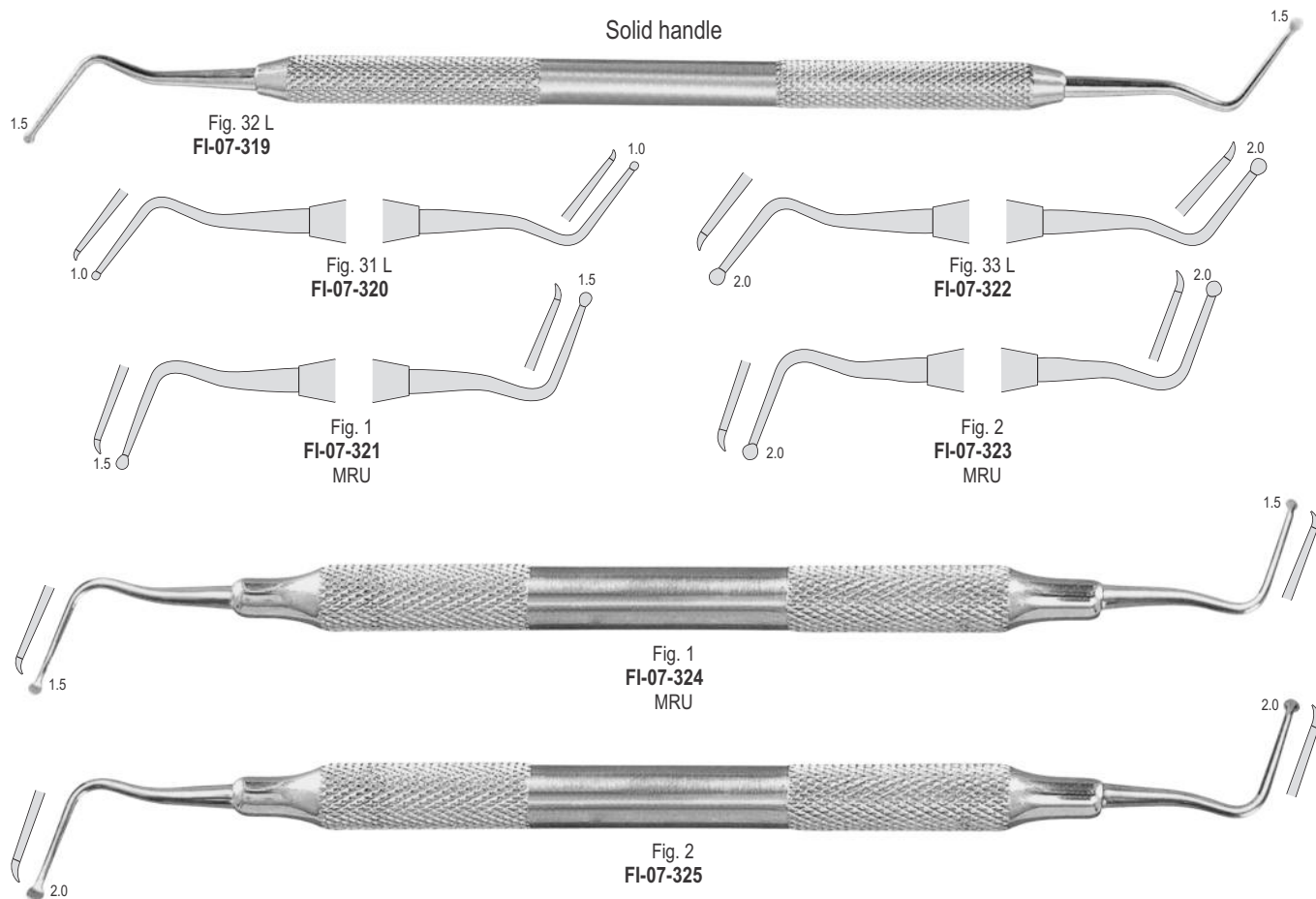
Towner



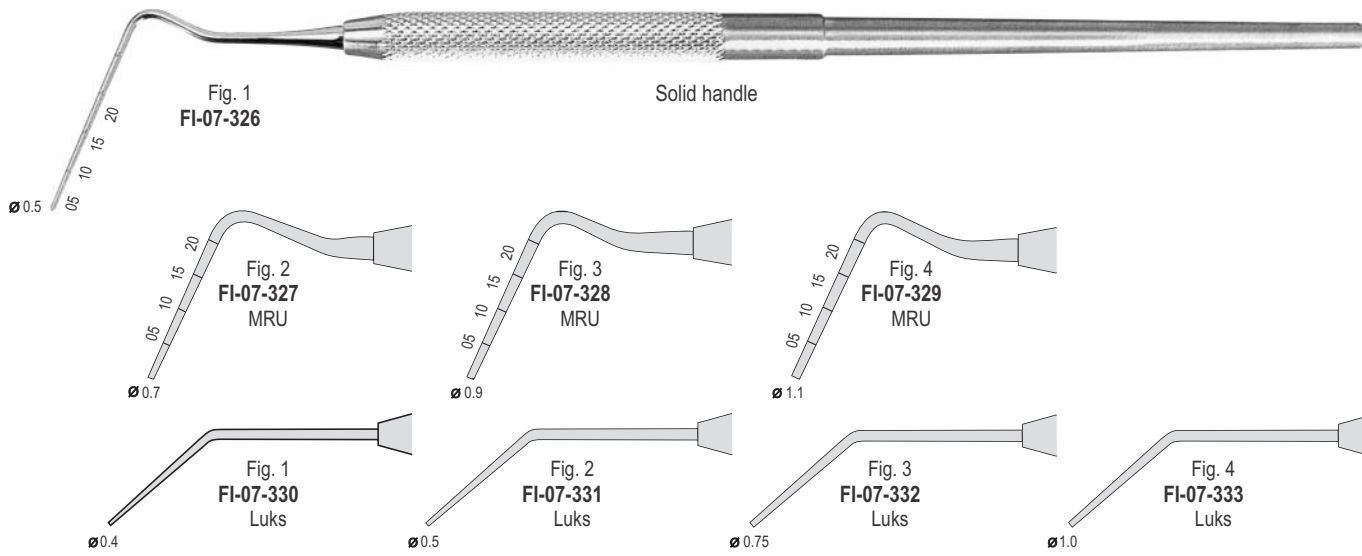
Endodontic explorers



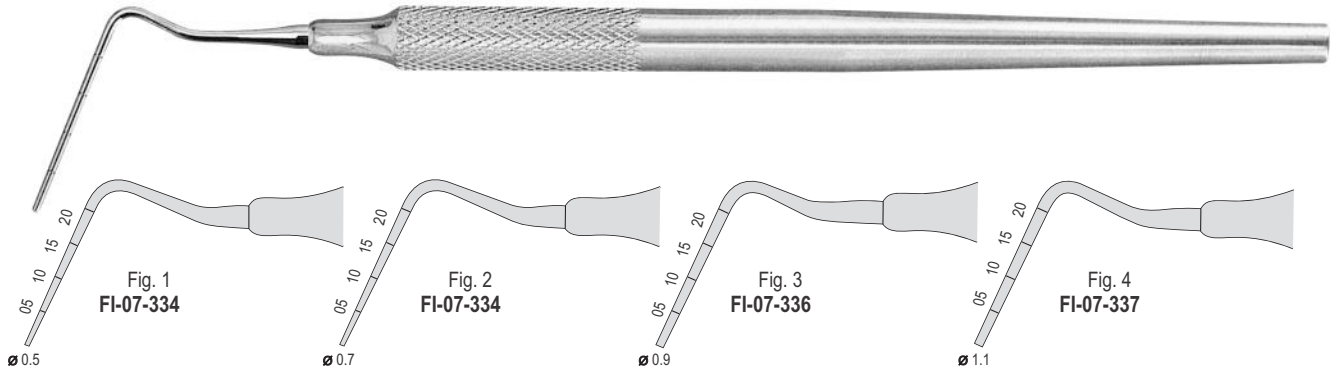
Endodontic excavators



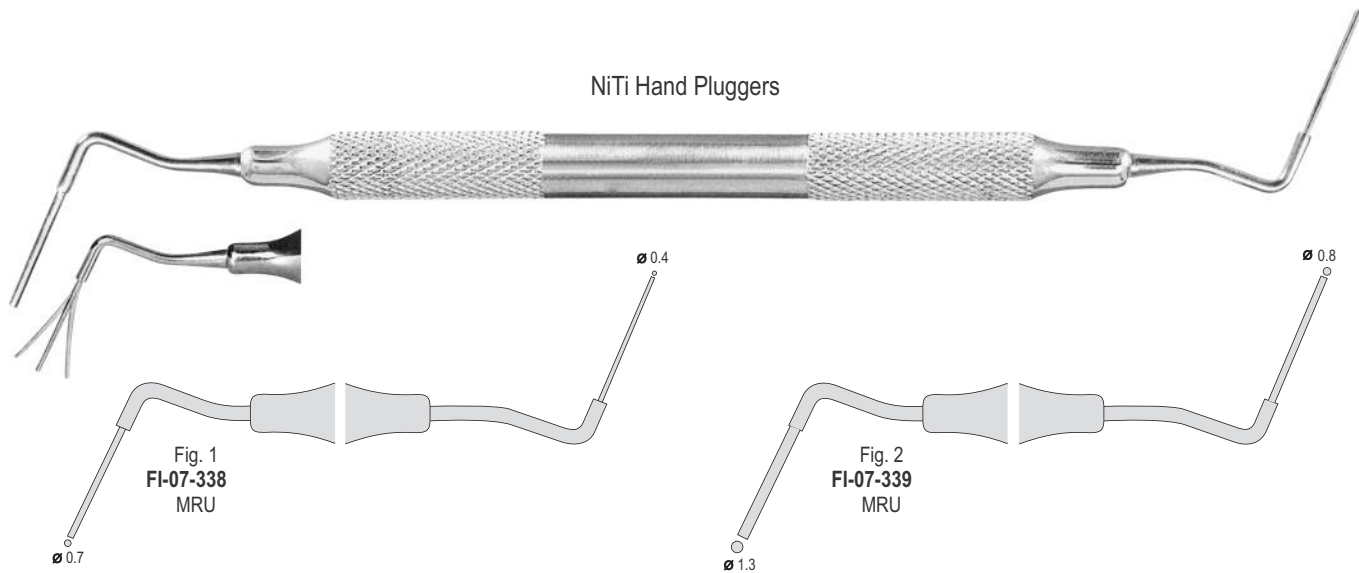
Hand Pluggers



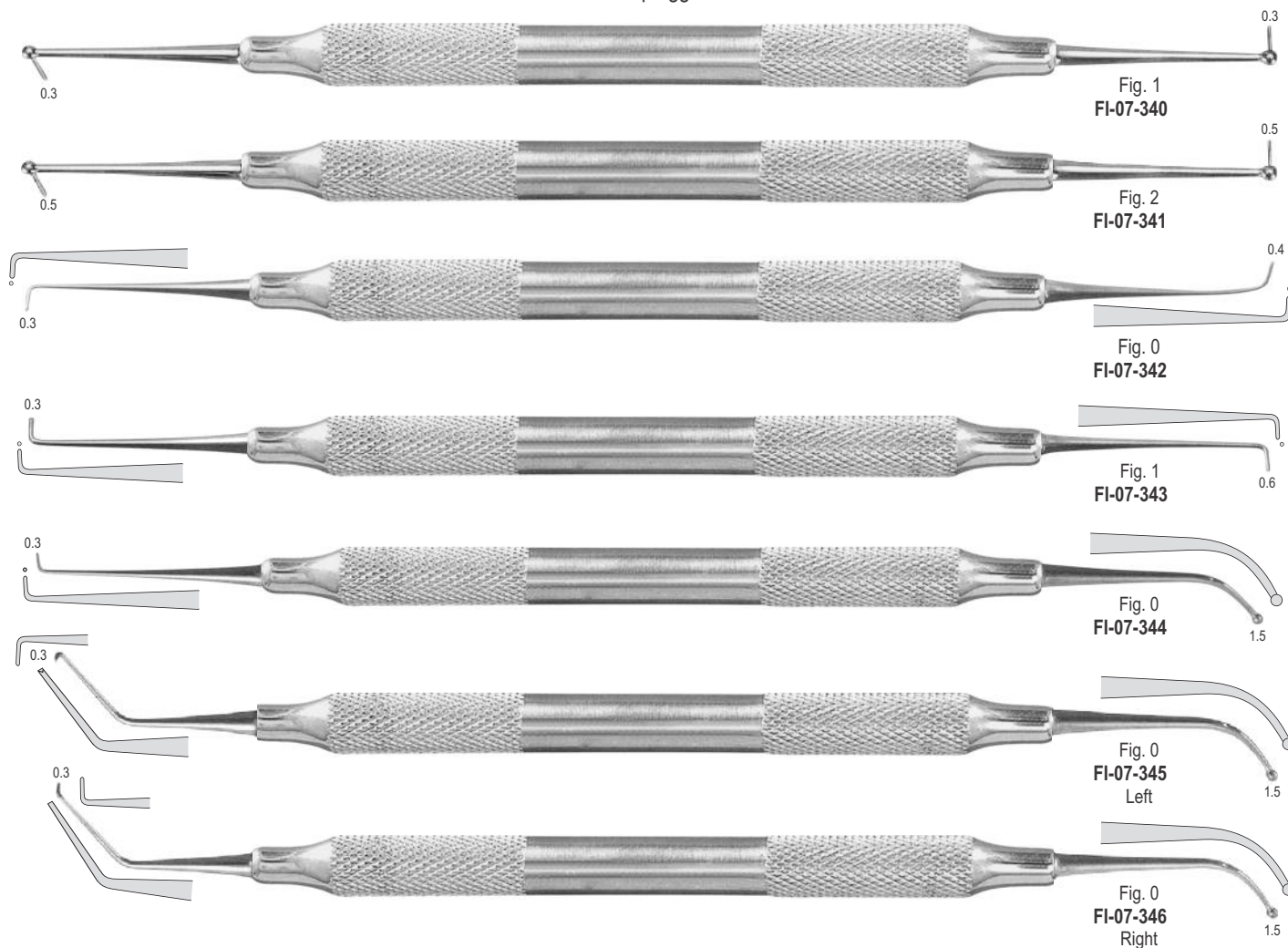
Hollow handle 8mm



NiTi Hand Pluggers

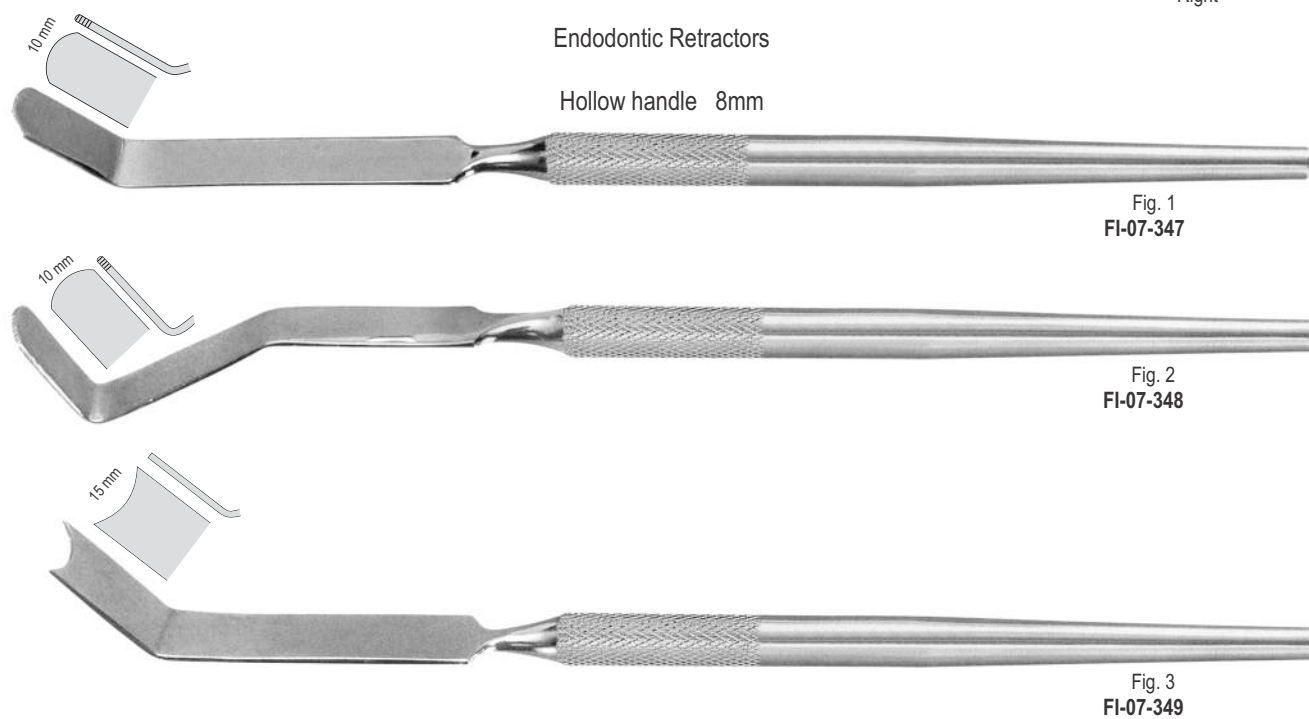


Micro endodontic pluggers/burnishers



Endodontic Retractors

Hollow handle 8mm



Endodontic Curettes

FI-07-350  
Molt



Fig.2/4



Fig.1



FI-07-351  
Ruddle  
Left



Fig.2



FI-07-352  
Ruddle  
Right



Fig.1



FI-07-353  
Ruddle  
Left



Fig.2



FI-07-354  
Ruddle  
Right

Hand Spreaders



Fig. 3  
FI-07-355

Solid handle



Fig. 1  
FI-07-356

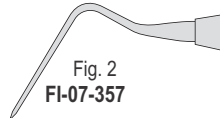


Fig. 2  
FI-07-357



Fig. 4  
FI-07-358

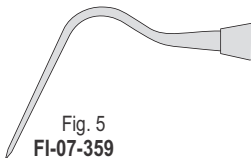


Fig. 5  
FI-07-359



Fig. 6  
FI-07-360

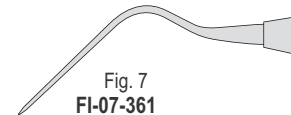


Fig. 7  
FI-07-361

Hollow handle



MRU  
8 mm

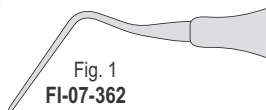


Fig. 1  
FI-07-362

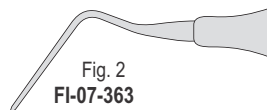


Fig. 2  
FI-07-363

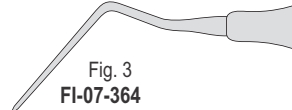


Fig. 3  
FI-07-364

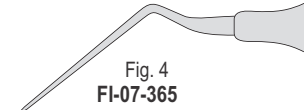
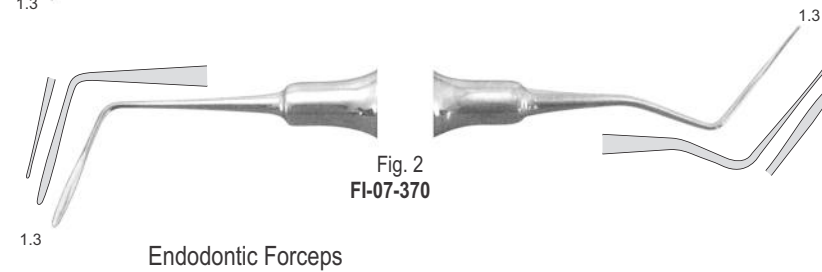
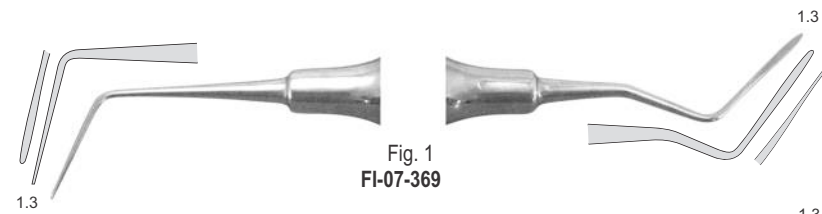
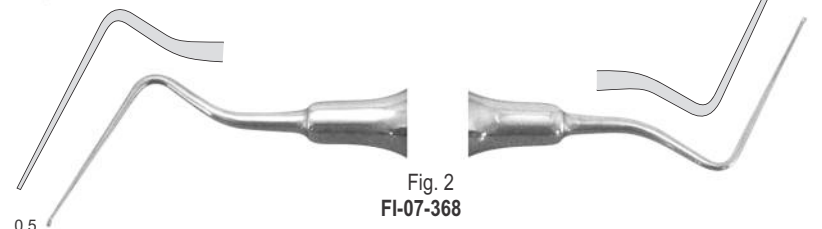
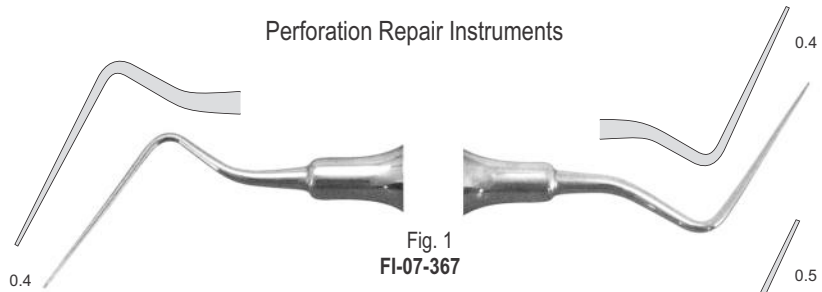


Fig. 4  
FI-07-365

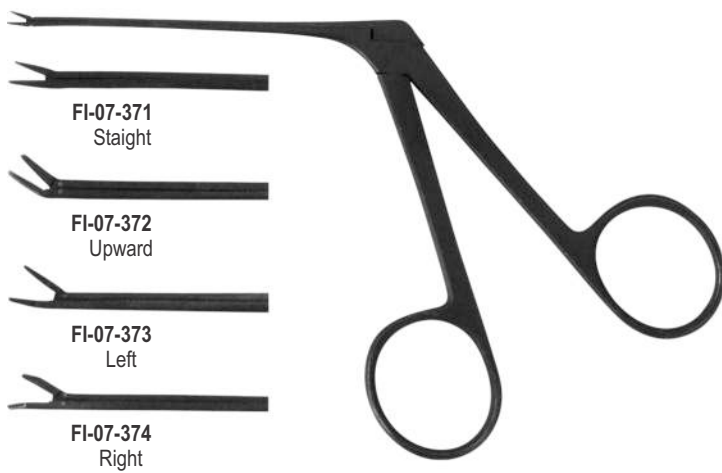


Perforation Repair Instruments



Endodontic Forceps

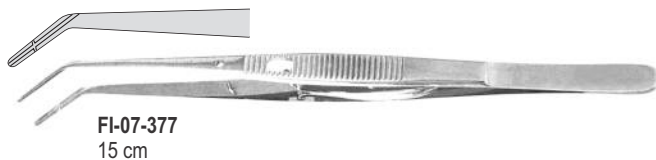
Micro forceps for removing broken files



Silver points and broken files removing forceps



Endodontic Tweezers



Silicone Handle, Ultra Light weight, Non-stick tips, TiN coated

**Pluggers**


Fig. 5A FI-07-378



Fig. 3 FI-07-379 Hollenback



Fig. 1 FI-07-380 Super



Fig. OT FI-07-381 Tanner



Fig. 0/1 FI-07-382



Fig. 1/2 FI-07-383



Fig. 21B FI-07-384 Acorn/Wescott



Fig. 1 FI-07-385 Contact Former



Fig. 2 FI-07-386 Contact Former

**Burnishers**


Fig. 2 FI-07-387 Ladmore



Fig. 3 FI-07-388 Ladmore



Fig. 27/29 FI-07-389



Fig. 1 FI-07-390



Fig. 1L FI-07-391



Fig. 155 FI-07-392



Fig. 156(A6) FI-07-393



Fig. 8A FI-07-394



Fig. 1 FI-07-395 Boghosian





Fig. 2 FI-07-396 Boghosian



Fig. 1 FI-07-397 MRU

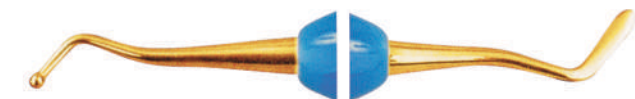


Fig. 2 FI-07-398 MRU



Fig. 1 FI-07-399 Goldstein



Fig. 2 FI-07-400 Goldstein



Fig. 3 FI-07-401 Goldstein



Fig. 4 FI-07-402 Goldstein



Fig. 1 FI-07-403 Goldstein-Mini



Fig. 3 FI-07-404 Goldstein-Mini



Fig. 4 FI-07-405 Goldstein-Mini



Fig. 1 FI-07-406 Goldstein-Micro



Fig. 4/5 FI-07-407 Gregg



Fig. 0 FI-07-408 Heidemann



Fig. 1 FI-07-409 Heidemann



Fig. 2 FI-07-410 Heidemann



Fig. W3 FI-07-411



Fig. 1 FI-07-412



Fig. 6 FI-07-413



Fig. 178 FI-07-414

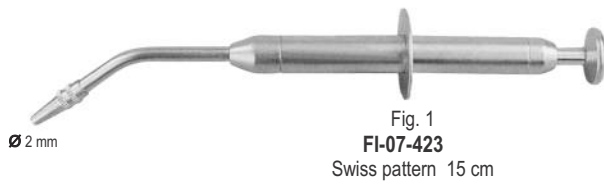
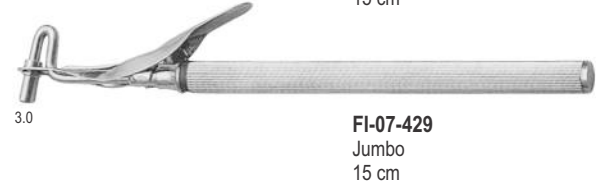
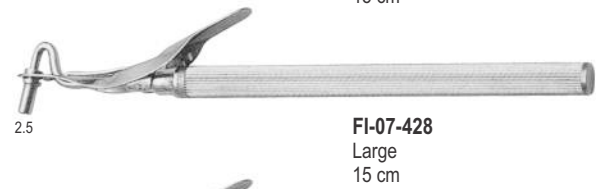
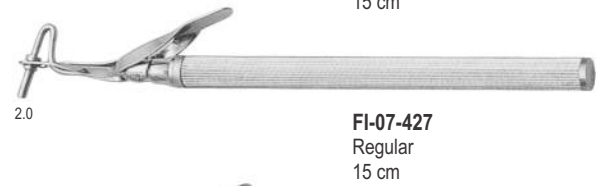
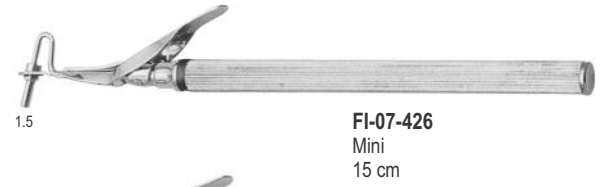
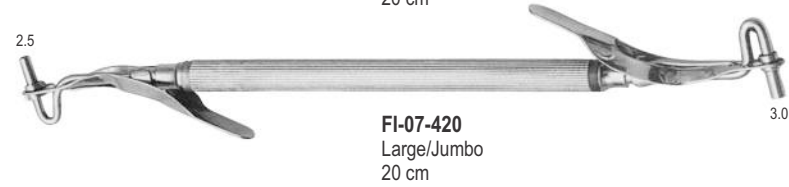
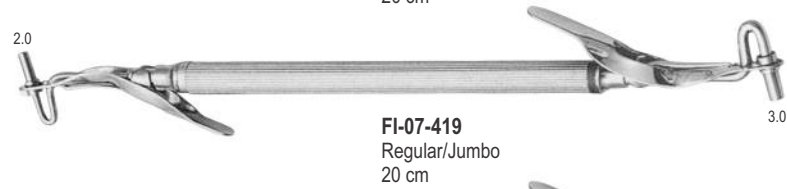
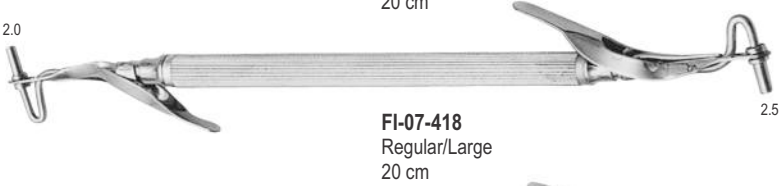
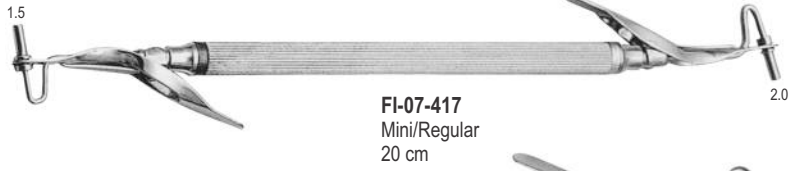


Fig. 49 FI-07-415



Fig. 179 FI-07-416

Amalgam Carriers



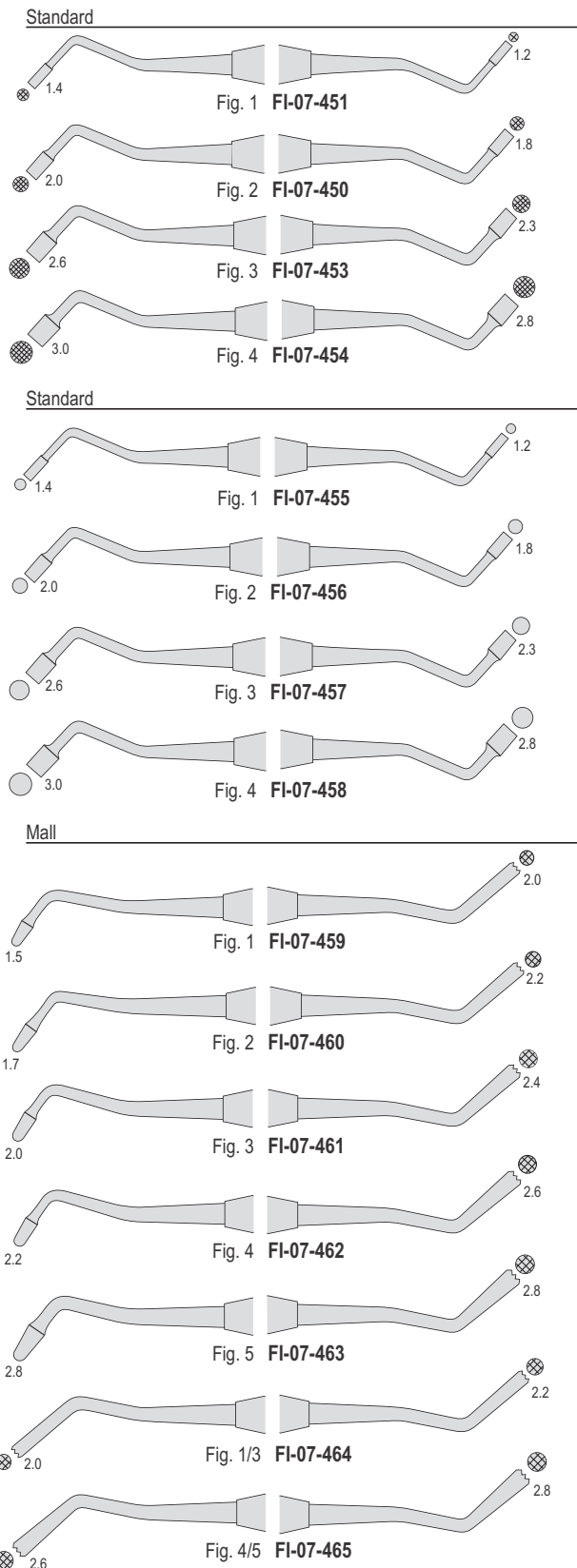
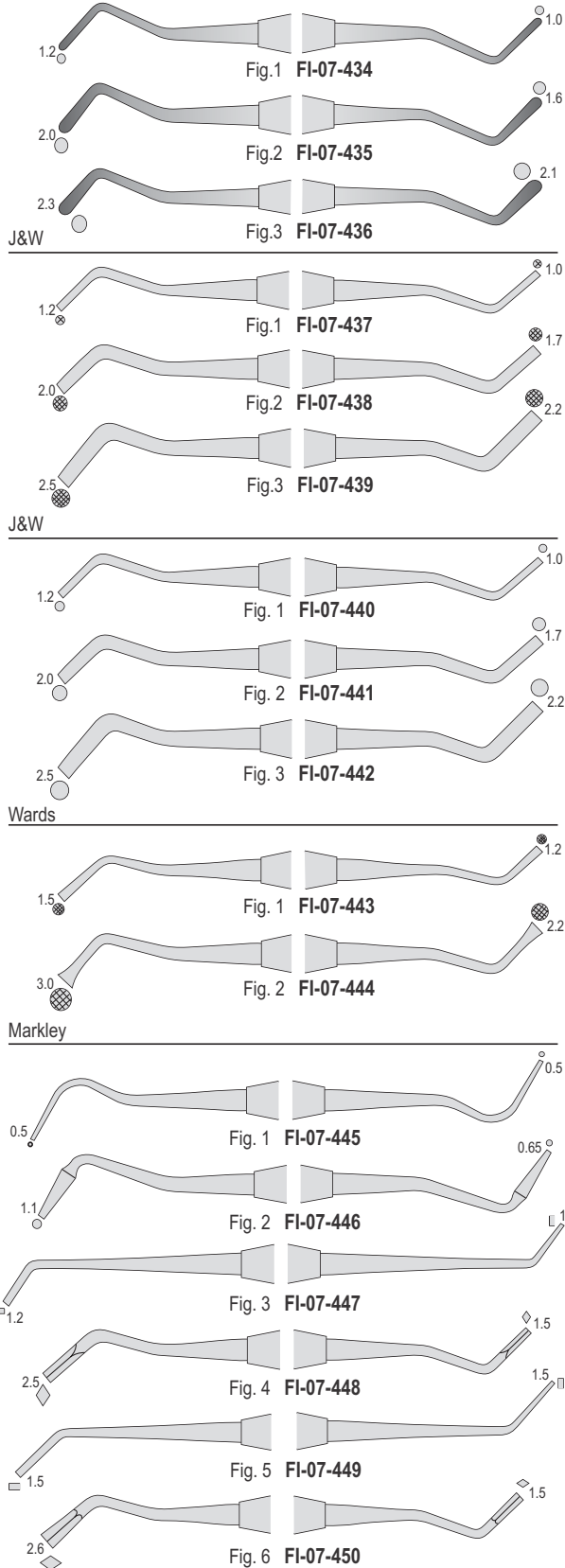
For micro filling



Amalgam well



Solid handle



Super Plugger Hollow 8 mm



Fig. 1 FI-07-466



Fig. 1 FI-07-467



Fig. 2 FI-07-468



Fig. 3 FI-07-469

J&W



Fig. 1 FI-07-470

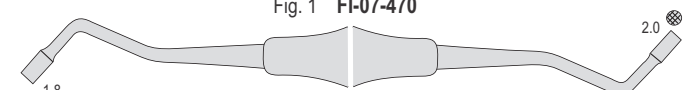


Fig. 2 FI-07-471

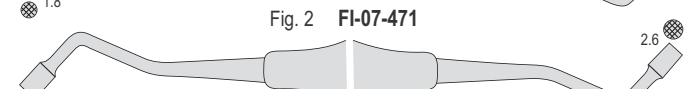


Fig. 3 FI-07-471



Fig. 4 FI-07-472

Markley



Fig. 1 FI-07-473



Fig. 2 FI-07-474

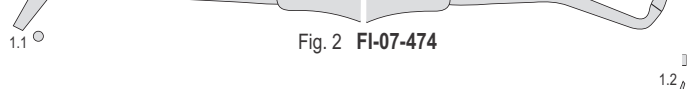


Fig. 3 FI-07-475

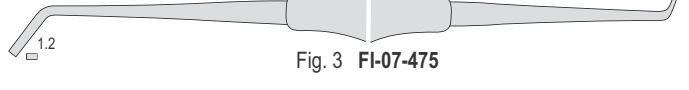


Fig. 4 FI-07-476

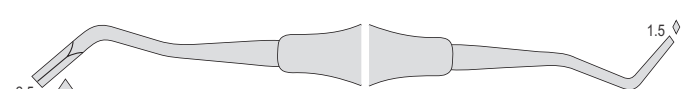


Fig. 5 FI-07-477

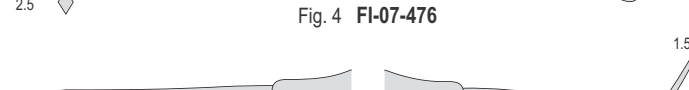


Fig. 6 FI-07-478

Solid handle



Black

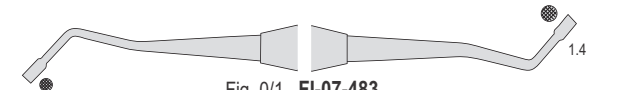


Fig. 0/1 FI-07-483

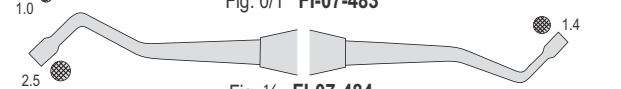


Fig. 1/2 FI-07-484

J&W Palma

J&W Palma

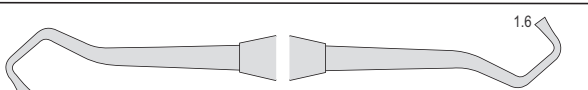


Fig. 1 FI-07-479

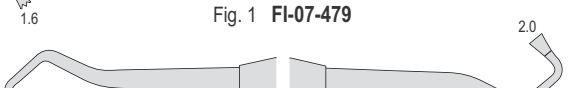


Fig. 2 FI-07-480

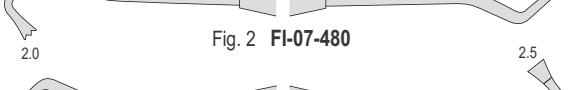


Fig. 3 FI-07-481

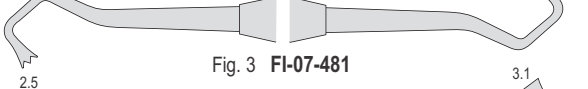


Fig. 4 FI-07-482

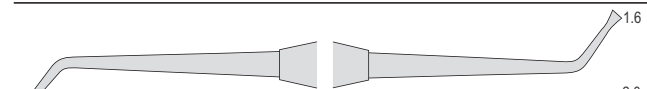


Fig. 1 FI-07-485

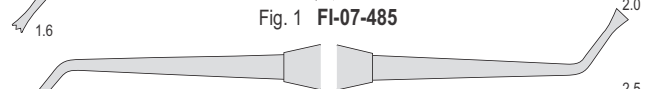


Fig. 2 FI-07-486

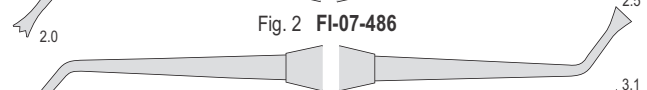


Fig. 3 FI-07-487

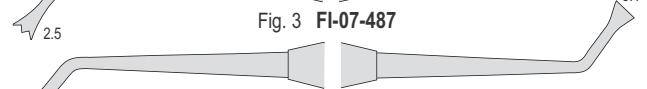
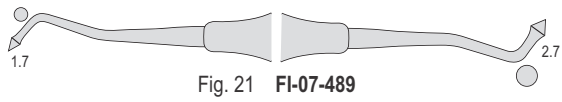


Fig. 4 FI-07-488

Hollow handle 8 mm



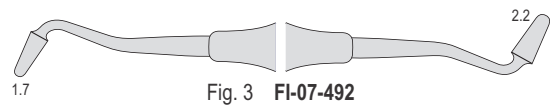
Acorn / Wescott



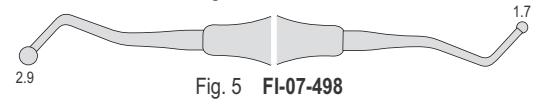
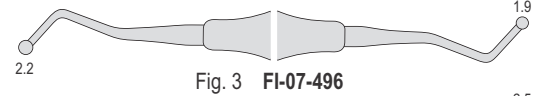
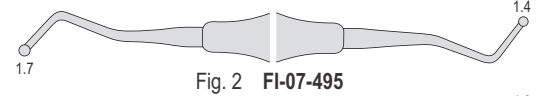
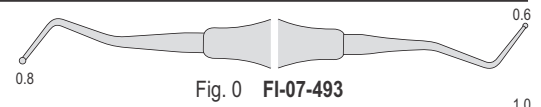
White



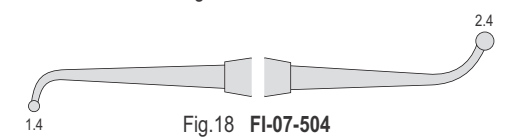
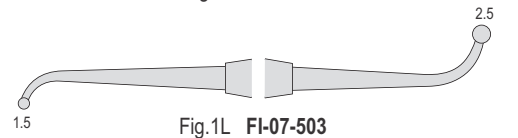
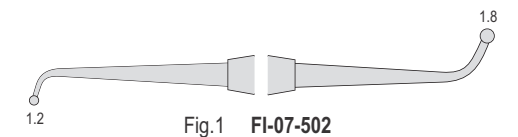
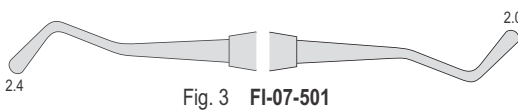
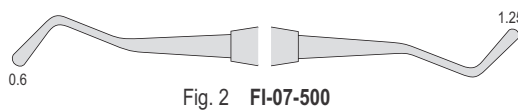
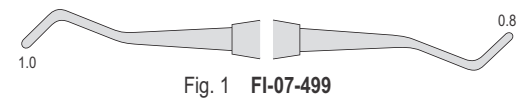
Freedman



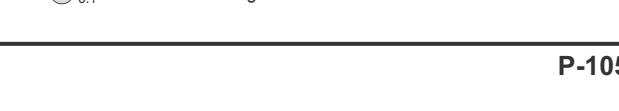
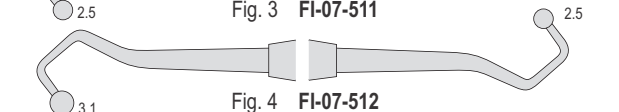
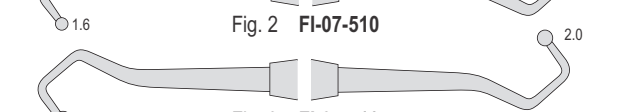
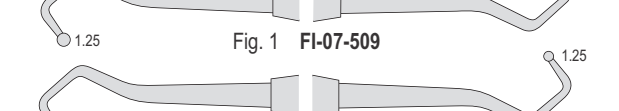
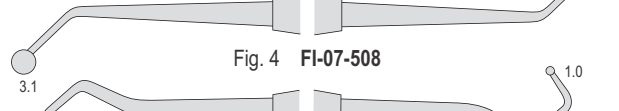
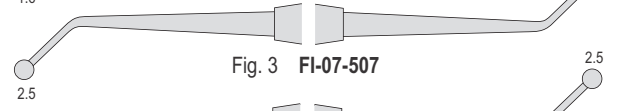
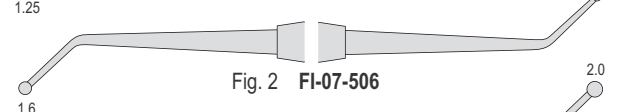
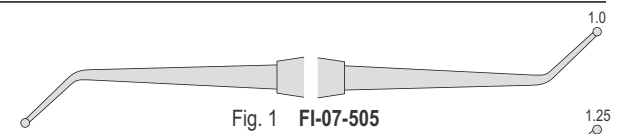
J&W



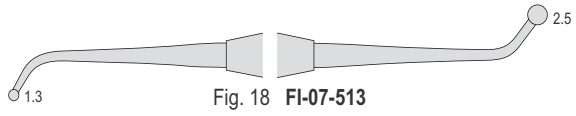
Solid Handle



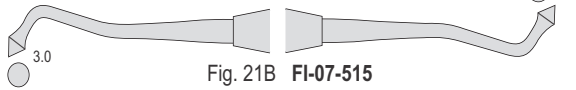
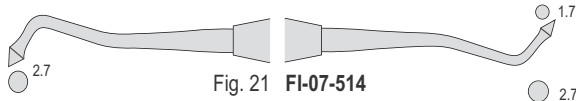
J&W Palma



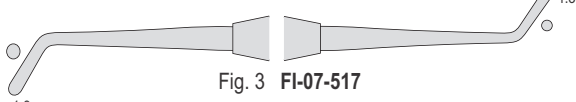
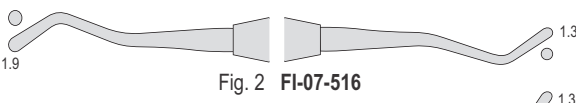
Solid handle



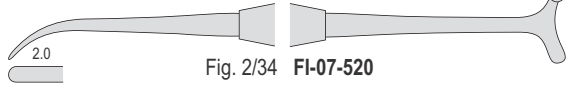
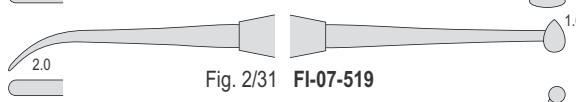
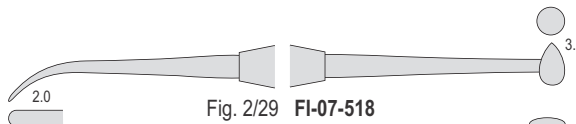
Acom / Wescott



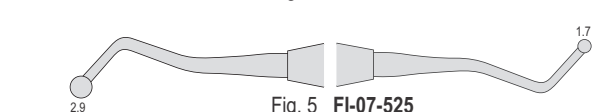
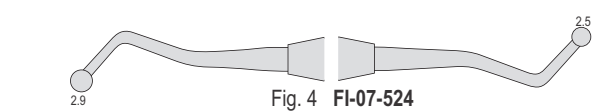
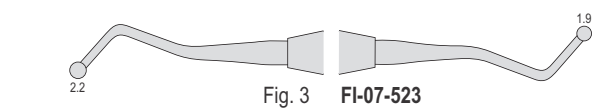
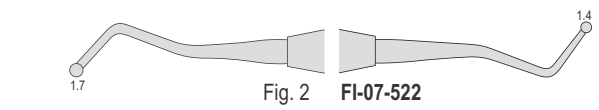
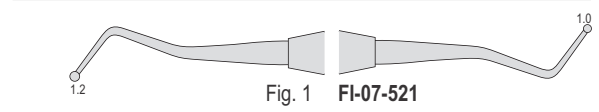
Ladmore



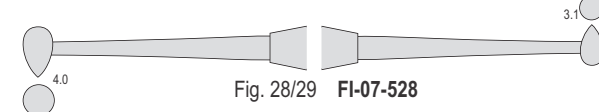
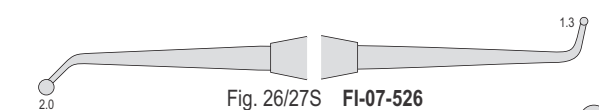
Beavertail / White



J&W



White

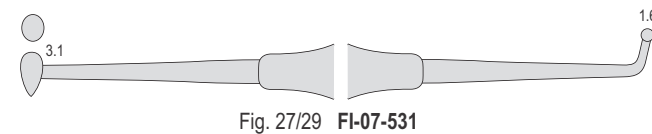


Hollow handle

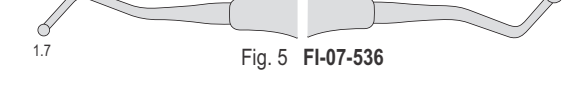
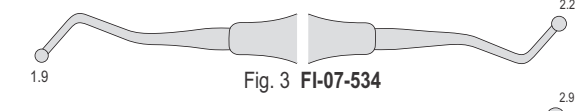
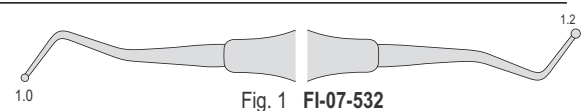
Acom / Wescott



White



J&W



Solid handle

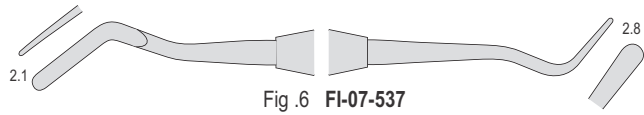
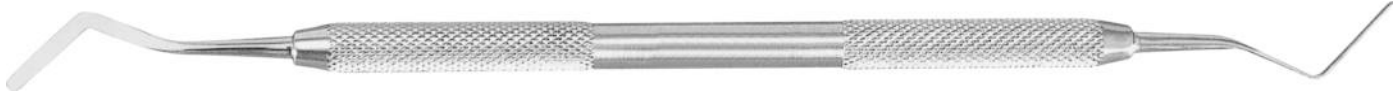


Fig. 6 FI-07-537

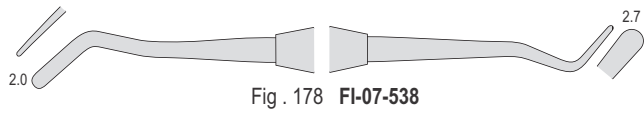


Fig. 178 FI-07-538

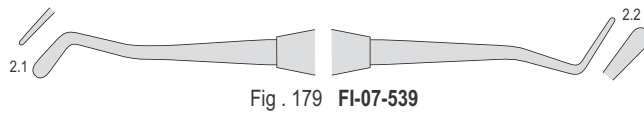


Fig. 179 FI-07-539

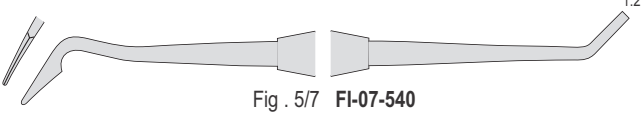


Fig. 5/7 FI-07-540

Gregg

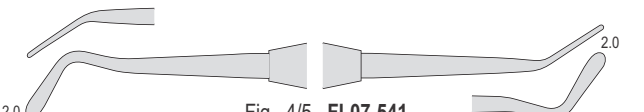


Fig. 4/5 FI-07-541

Woodson

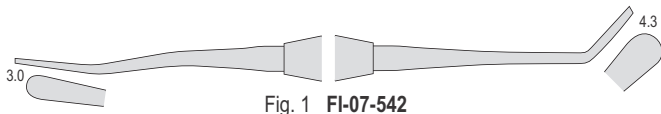


Fig. 1 FI-07-542

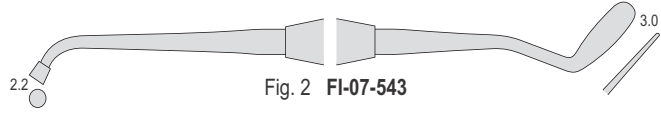


Fig. 2 FI-07-543

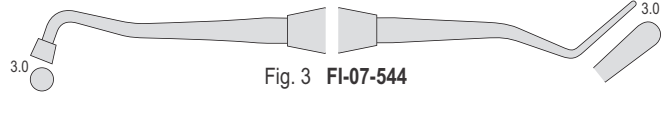


Fig. 3 FI-07-544

Heidemann

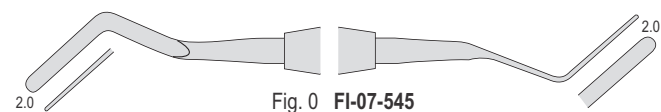


Fig. 0 FI-07-545

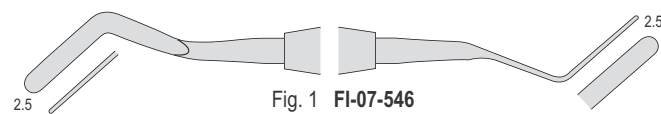


Fig. 1 FI-07-546

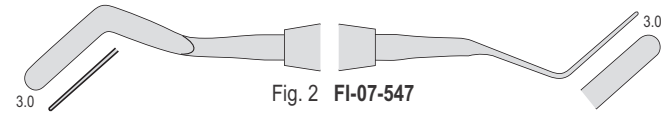


Fig. 2 FI-07-547

J&W

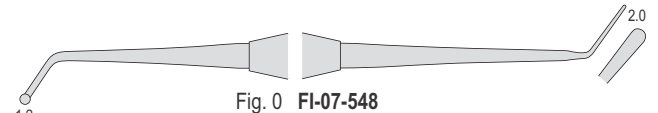


Fig. 0 FI-07-548

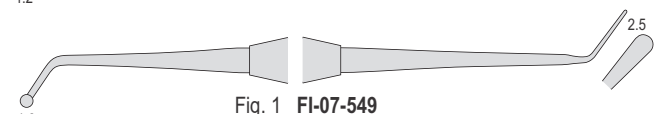


Fig. 1 FI-07-549



Fig. 2 FI-07-550

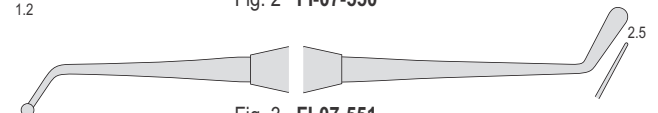


Fig. 3 FI-07-551

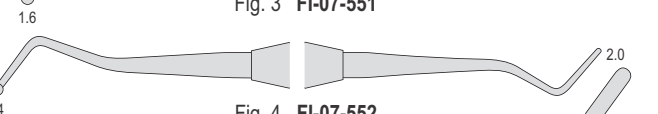


Fig. 4 FI-07-552

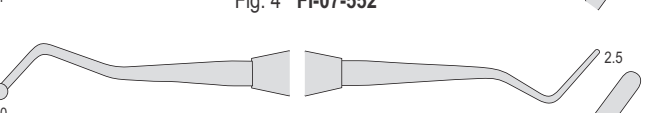


Fig. 5 FI-07-553

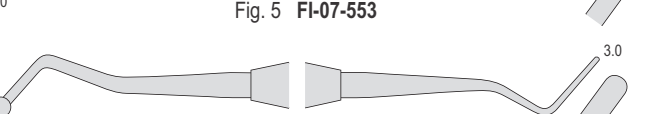


Fig. 6 FI-07-554

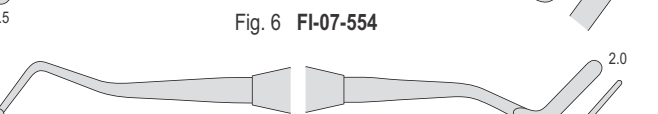


Fig. 7 FI-07-555

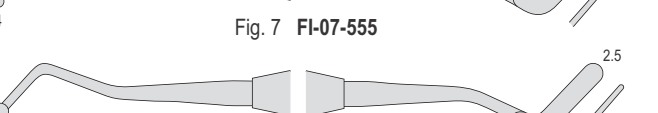


Fig. 8 FI-07-556

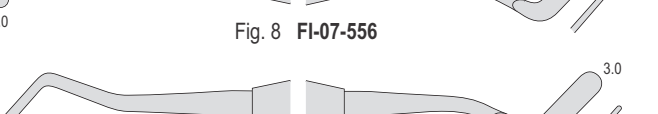


Fig. 9 FI-07-557

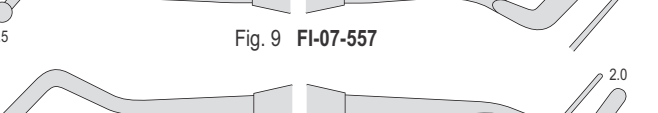


Fig. 10 FI-07-558

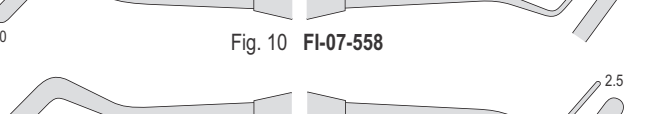


Fig. 11 FI-07-559

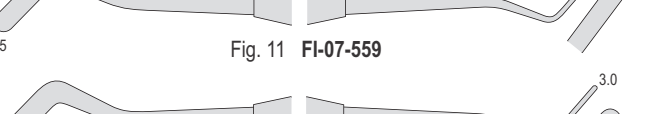
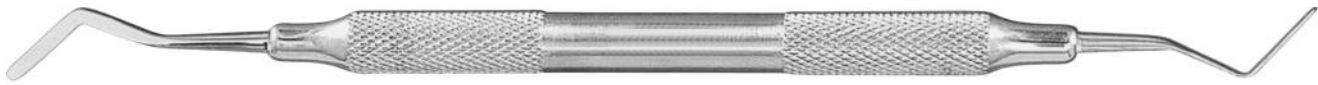
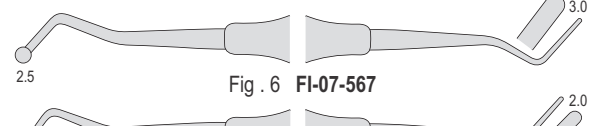
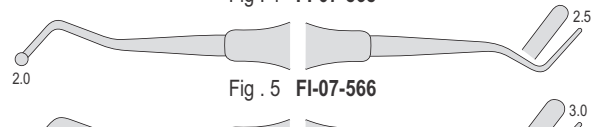
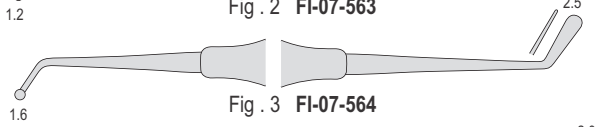
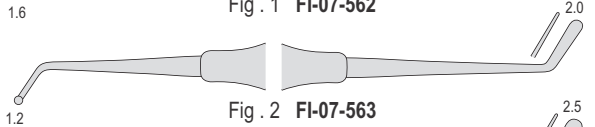
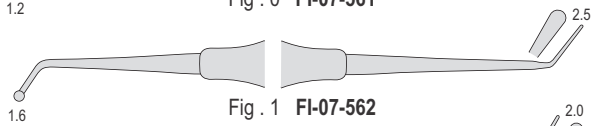
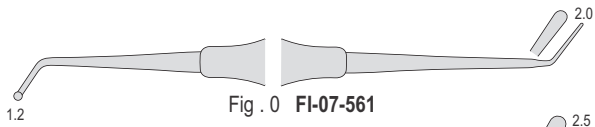


Fig. 12 FI-07-560

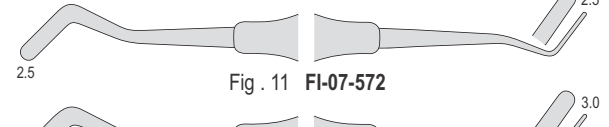
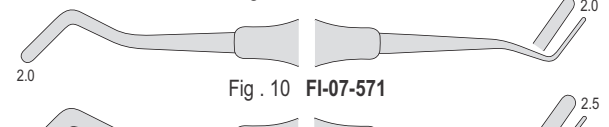
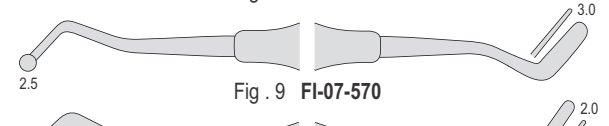
Hollow handle



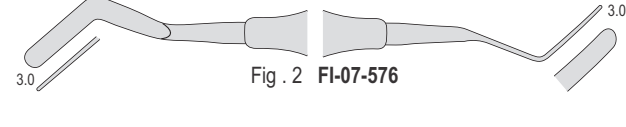
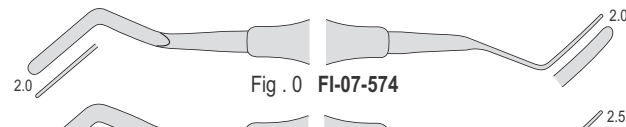
J&W



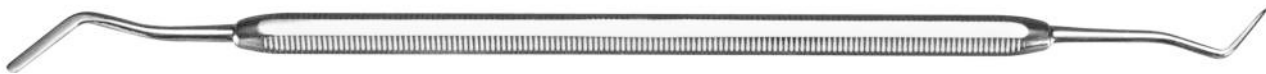
J&W



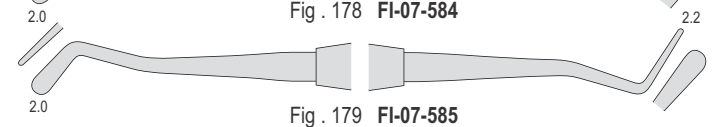
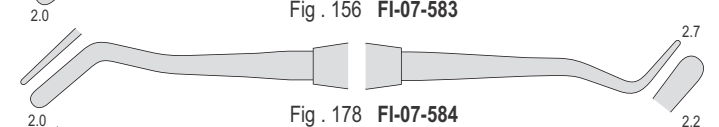
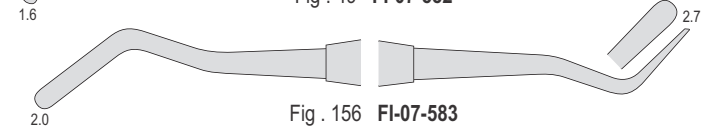
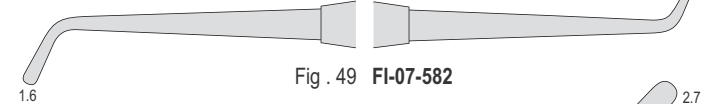
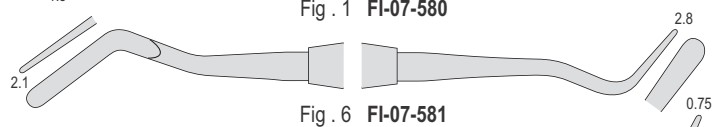
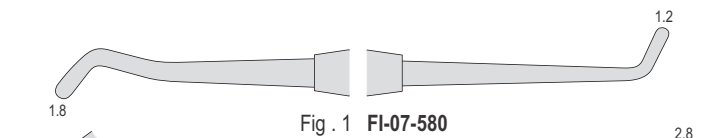
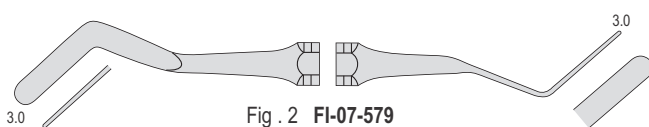
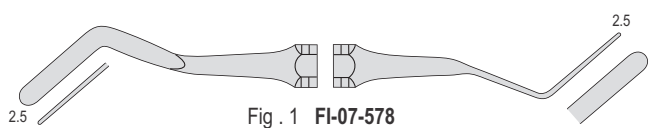
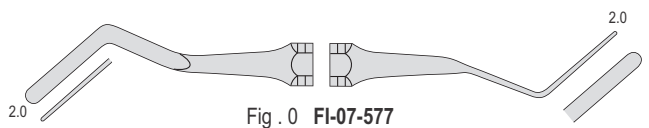
Heidemann



Solid handle



J&W







Blue-Yellow

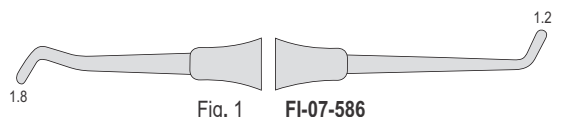


Fig. 1 FI-07-586

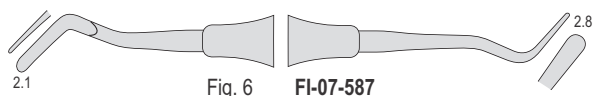


Fig. 6 FI-07-587

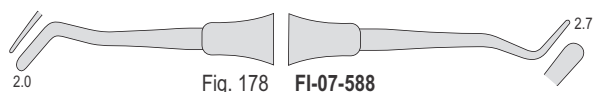


Fig. 178 FI-07-588

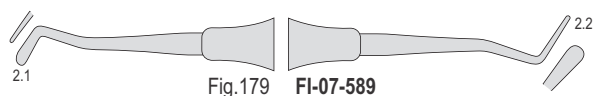


Fig. 179 FI-07-589

Heidemann

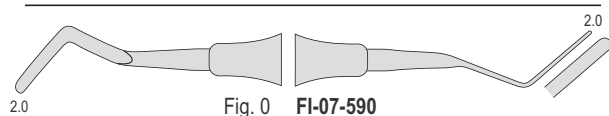


Fig. 0 FI-07-590

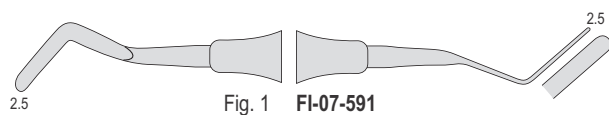


Fig. 1 FI-07-591

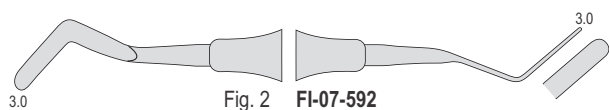


Fig. 2 FI-07-592

J&W

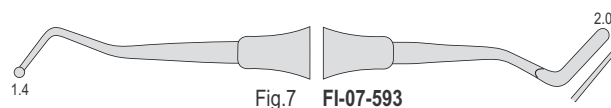


Fig. 7 FI-07-593

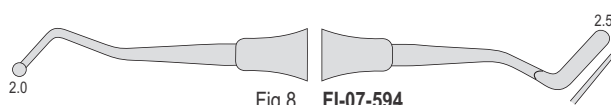


Fig. 8 FI-07-594

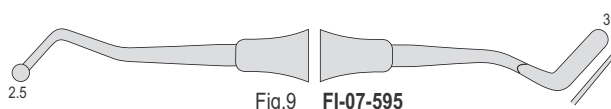


Fig. 9 FI-07-595

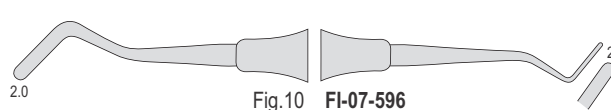


Fig. 10 FI-07-596

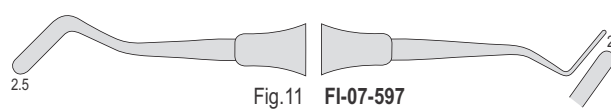


Fig. 11 FI-07-597

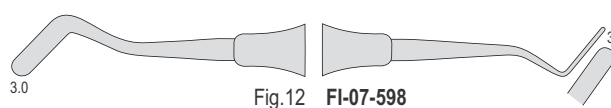


Fig. 12 FI-07-598

Gregg

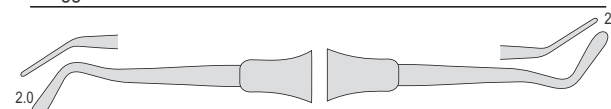
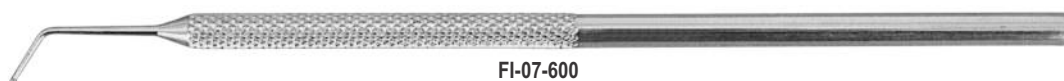


Fig. 4/5 FI-07-599

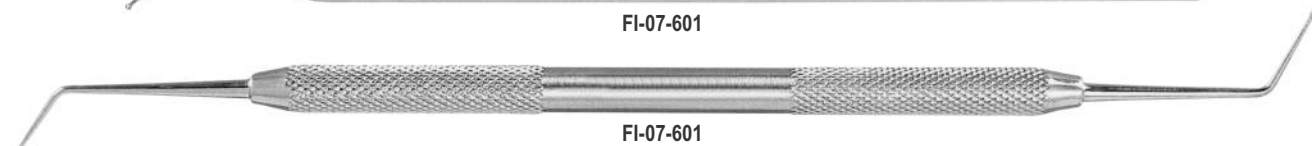
Applicators for calcium hydroxide



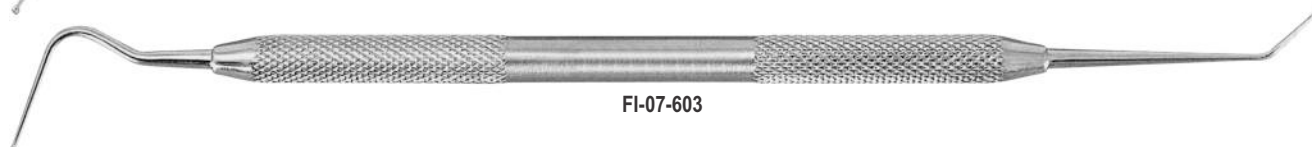
FI-07-600



FI-07-601



FI-07-601



FI-07-603

Applicator for medicaments



FI-07-604

Orban



Blue-Yellow

J&W

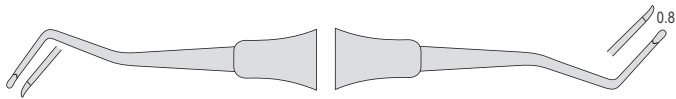


Fig. 0 FI-07-605

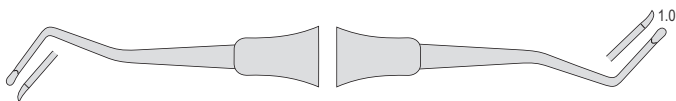


Fig. 1 FI-07-606

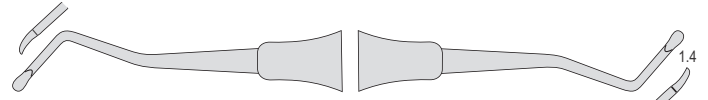


Fig. 2 FI-07-607

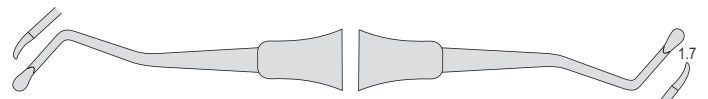


Fig. 3 FI-07-608

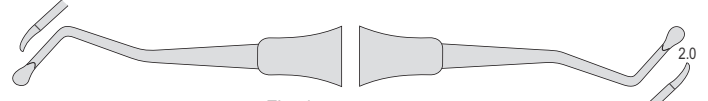


Fig. 4 FI-07-609



Solid handle

J&W



Fig. 0 FI-07-610

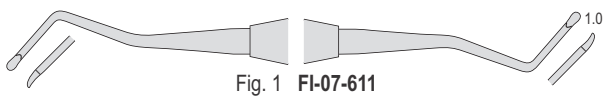


Fig. 1 FI-07-611

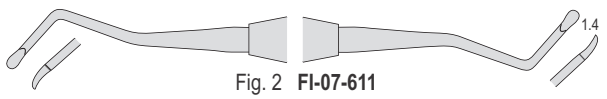


Fig. 2 FI-07-611

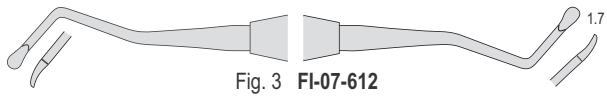


Fig. 3 FI-07-612

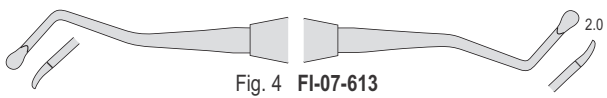


Fig. 4 FI-07-613

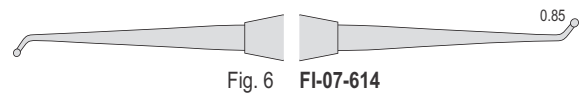


Fig. 6 FI-07-614

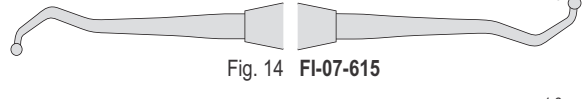


Fig. 14 FI-07-615

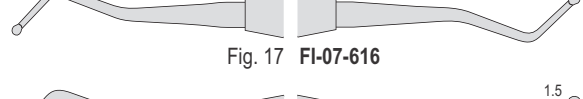


Fig. 17 FI-07-616

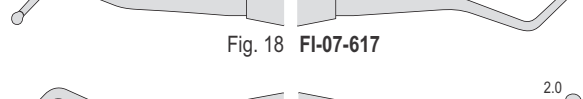


Fig. 18 FI-07-617

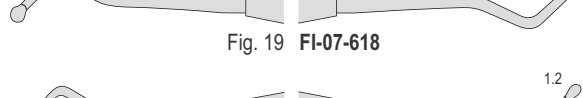


Fig. 19 FI-07-618

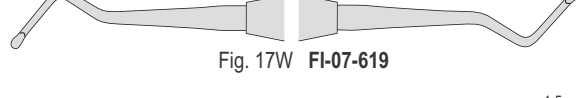


Fig. 17W FI-07-619

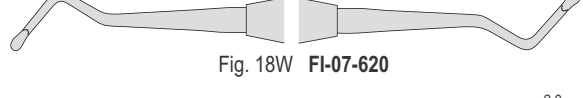


Fig. 18W FI-07-620

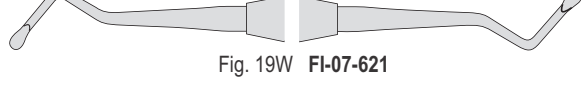
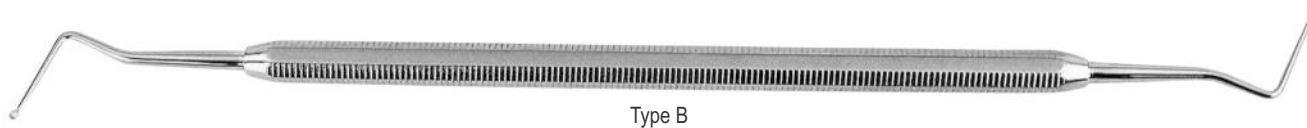
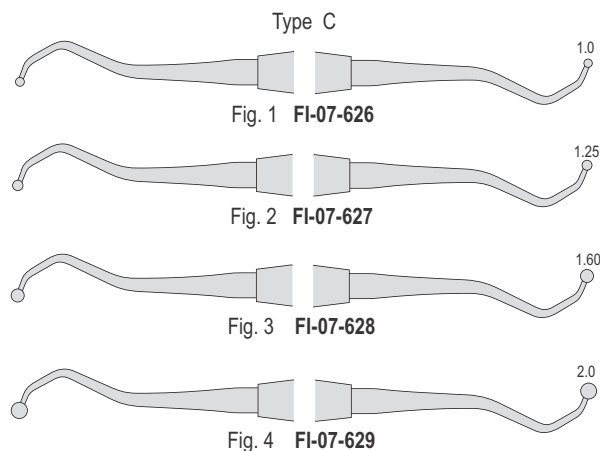
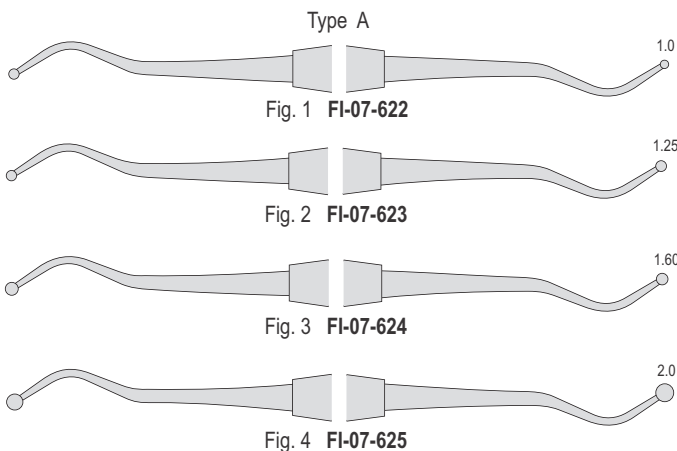


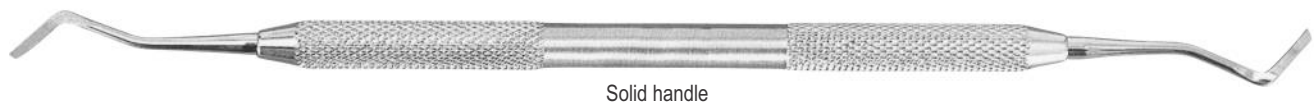
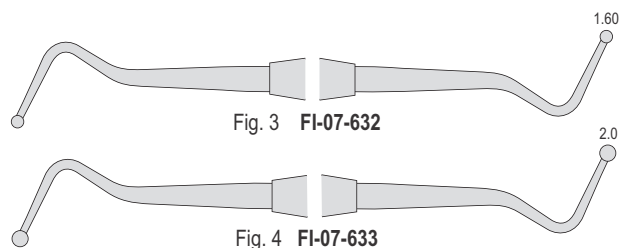
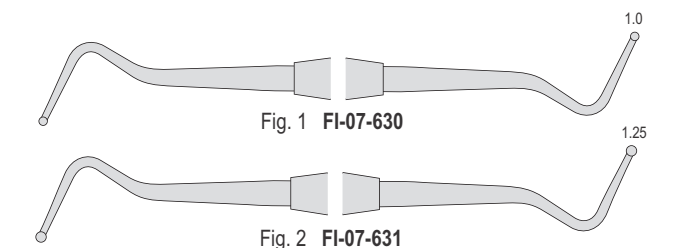
Fig. 19W FI-07-621



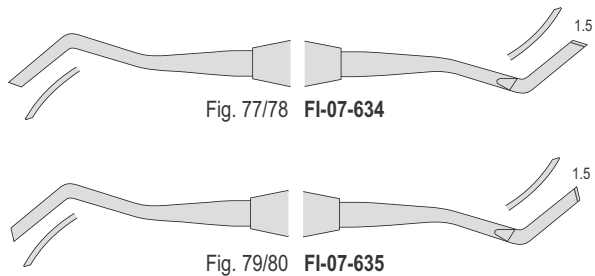
J&W Palma



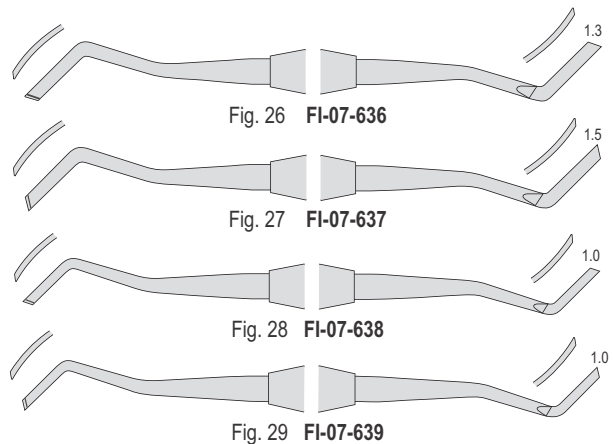
J&W Palma



Blacks



Ferrier



Carvers

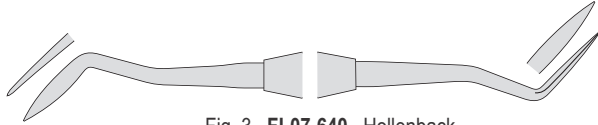


Fig. 3 FI-07-640 Hollenback

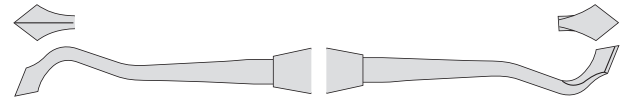


Fig. 2/3 FI-07-644 Frahm

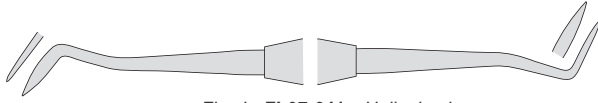


Fig. 4 FI-07-641 Hollenback

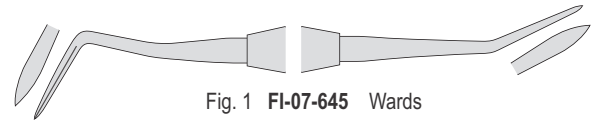


Fig. 1 FI-07-645 Wards

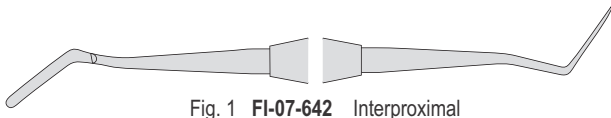


Fig. 1 FI-07-642 Interproximal

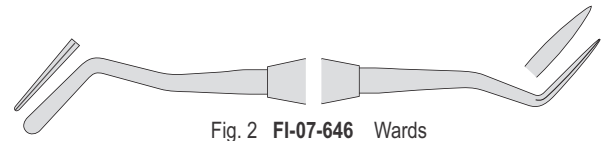


Fig. 2 FI-07-646 Wards

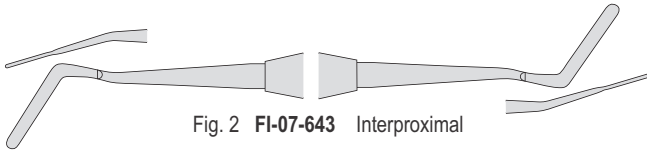


Fig. 2 FI-07-643 Interproximal

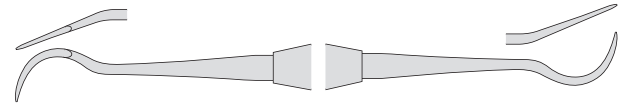


Fig. 8 FI-07-647 Wiland

Carvers



Fig. 3 FI-07-648 Hollenback



Fig. 3 1/2 FI-07-649 Hollenback

Finishing knives

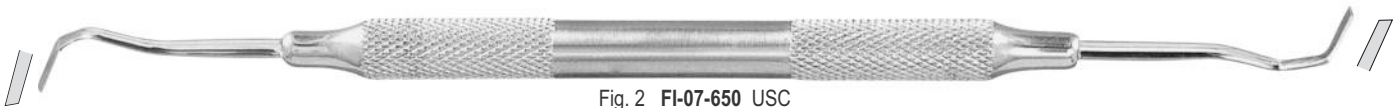


Fig. 2 FI-07-650 USC



Fig. 2S FI-07-651 USC



Fig. 28 FI-07-652 Black



Fig. 29 FI-07-653 Black

Finishing knives

Hollow handle



Fig. 6T FI-07-654 Tanner



Fig. 2 FI-07-655 USC



Fig. 2S FI-07-656 USC

Cleoid - Discoid

Solid handle

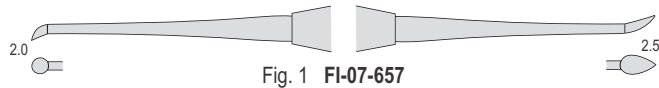


Fig. 1 FI-07-657

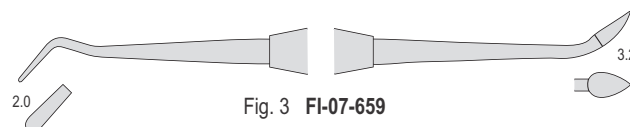


Fig. 3 FI-07-659



Fig. 2 FI-07-658

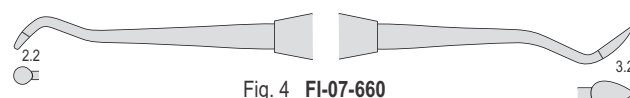


Fig. 4 FI-07-660

Cleoid - Discoid

Yellow-Orange

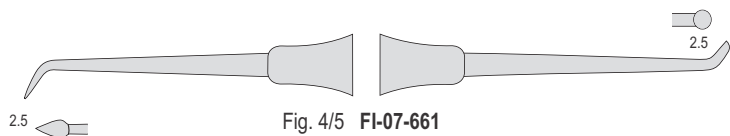


Fig. 4/5 FI-07-661

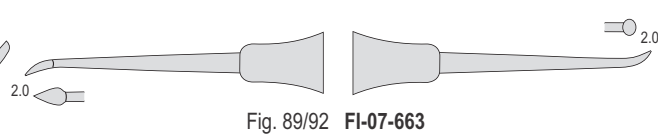


Fig. 89/92 FI-07-663

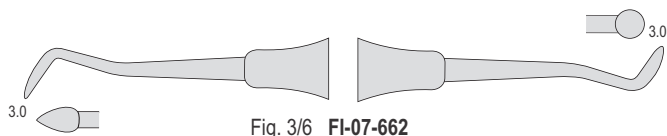


Fig. 3/6 FI-07-662

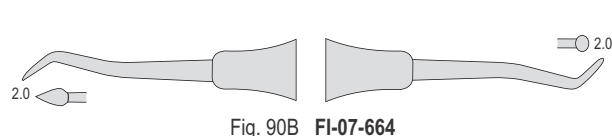


Fig. 90B FI-07-664

Filling removing instrument



Fig. 1 FI-07-665 Yellow-Orange

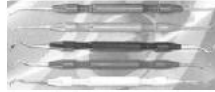
P.K. Thomas



Fig. 1 FI-07-666 Green



Fig. 2 FI-07-667 Yellow



54-B  
Set of 5 Pieces



Fig. 4 FI-07-669 Orange



Fig. 3 FI-07-668 Blue



Fig. 5 FI-07-670 Silver



Fig. 1 FI-07-671



Fig. 2 FI-07-672



FI-07-676  
P.K. Thomas  
Set of 5 Pieces



Fig. 4 FI-07-674



Fig. 3 FI-07-673



Fig. 5 FI-07-675



Fig. 7 FI-07-677 Beale



Fig. 31 FI-07-678 Gritman



Fig. 10 FI-07-680 Lecron



Fig. 10 FI-07-679 Hylin



Fig. 10 FI-07-681 Zahle



Fig. 1 FI-07-682 Vehe



Fig. 31 FI-07-683 Gritman



Fig. 13 FI-07-685



Fig. 12 FI-07-684



Fig. 1 FI-07-686 Beale



Fig. 1 FI-07-687 Roach

Akers Carver



FI-07-688 Akers Complete



FI-07-689 Spoon Only

54-493-00 Handle Only

FI-07-690 Knife Tip Only



FI-07-691 FI-07-692 FI-07-693 FI-07-694 FI-07-695 FI-07-696 FI-07-697 FI-07-698 FI-07-699 FI-07-700 FI-07-701 FI-07-702 FI-07-703



FI-07-704 FI-07-705 FI-07-706 FI-07-707 FI-07-708 FI-07-709 FI-07-710 FI-07-711 FI-07-712 FI-07-713 FI-07-714 FI-07-715 FI-07-716



Fig. 1 FI-07-717 Hollow handle



Fig. 2 FI-07-718 Hollow handle



Fig. 3 FI-07-719 Solid handle



Fig. 1 FI-07-720 Solid handle



Fig. 2 FI-07-721 Solid handle



Fig. 3 FI-07-722



Fig. 00 FI-07-723

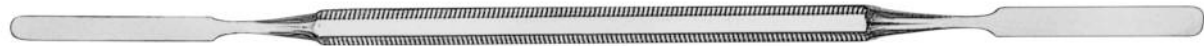


Fig. 0 FI-07-724

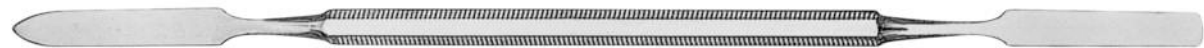


Fig. 1 FI-07-725



Fig. 2 FI-07-726

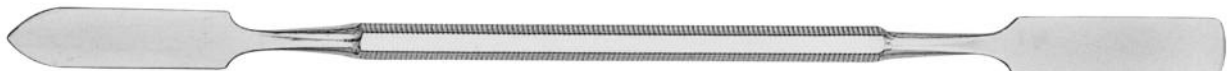


Fig. 3 FI-07-727



Fig. 4 FI-07-728



Weston FI-07-729



FI-07-730



FI-07-731

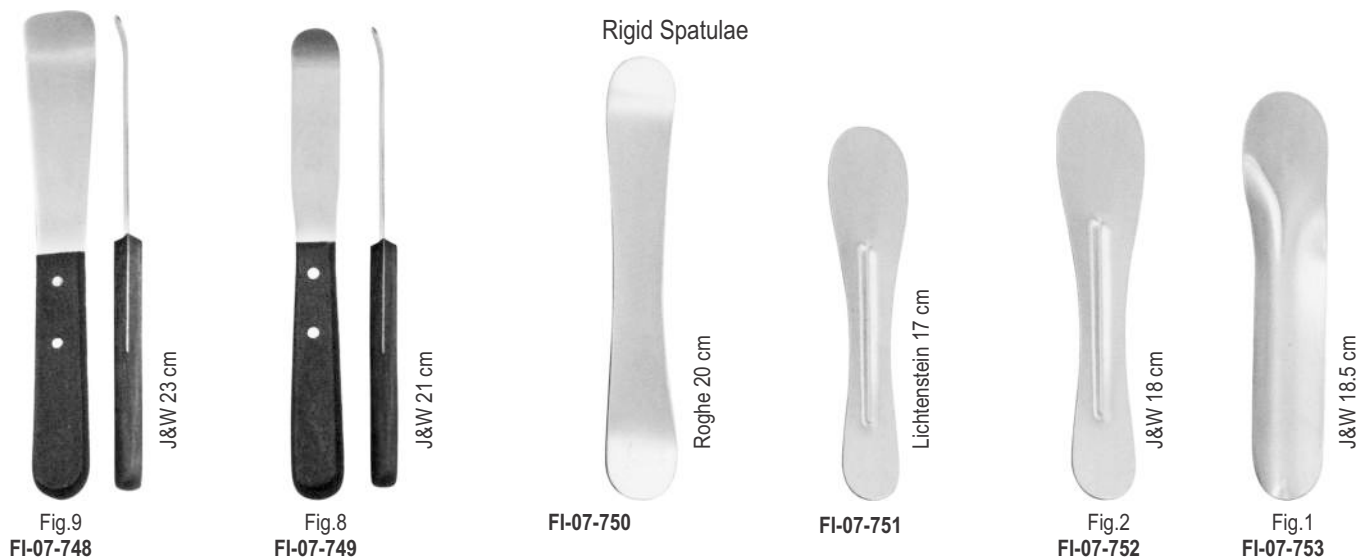




Flexible Spatulae



Rigid Spatulae



Wax knives with plastic handle  
 (Available in different colours)


FI-07-754 Fahnestock 13 cm



FI-07-756 Lessmann 13 cm



FI-07-755 Fahnestock 17.5 cm



FI-07-757 Lessmann 17.5 cm

## Wax knives with wooden handle



FI-07-758 Fahnestock 13 cm



FI-07-760 Lessmann 13 cm



FI-07-759 Fahnestock 17.5 cm



FI-07-761 Lessmann 17.5 cm



FI-07-762 with spoon 13 cm



FI-07-763 with spoon 17.5 cm

## Wax knives Ermert



FI-07-764 Wooden handle

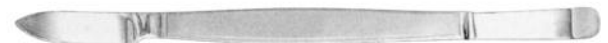


FI-07-765 Plastic handle



FI-07-766 Metal handle

## Wax knives with metal handle



FI-07-767 Fahnestock 13 cm



FI-07-768 Fahnestock 17.5 cm



FI-07-769 Lessmann 13 cm



FI-07-770 Lessmann 17.5 cm



08

Page 119-133

## Crown Removers

Crown Removers & Forceps for Articulating Paper

Crown Spreaders

Rubber Dam Instruments

Matrix Retainers & Rubber Dam Frames

Ligature & Separators Placing Pliers

Elastic Ligature Placing Forceps

Elastic Applicators & Ligature Tuckers

Bracket Positioning Instruments

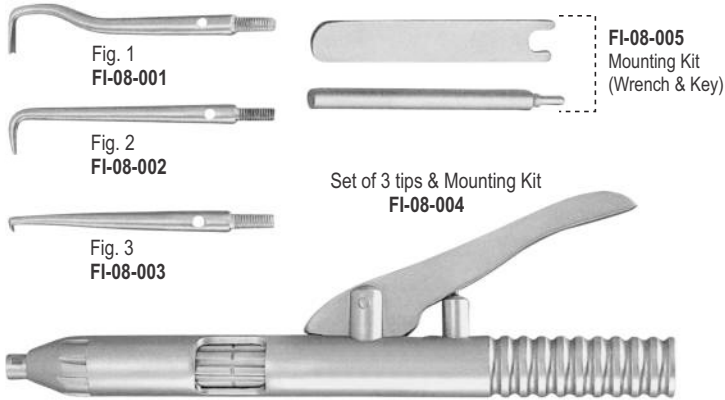
Bracket & Measuring Instruments

Laboratory Instruments

Crown Instruments & Grinding Stones

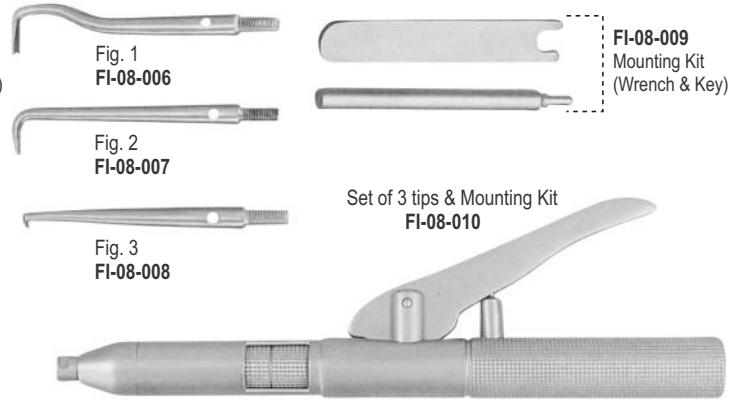
X - Ray Holders & Laboratory Bowls

Automatic Crown & Bridge Remover



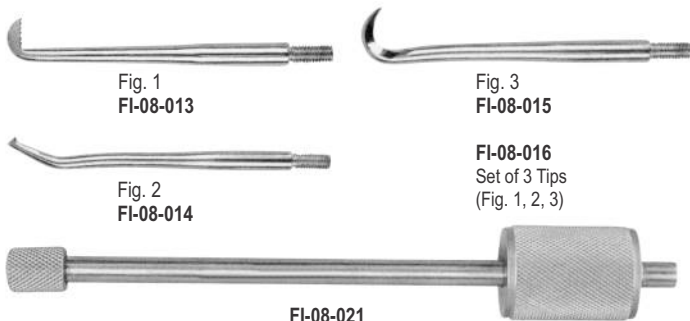
**FI-08-011**  
Contents: 1 Crown Remover, Mounting Kit (Wrench & Key), 3 Tips

Automatic Crown & Bridge Remover



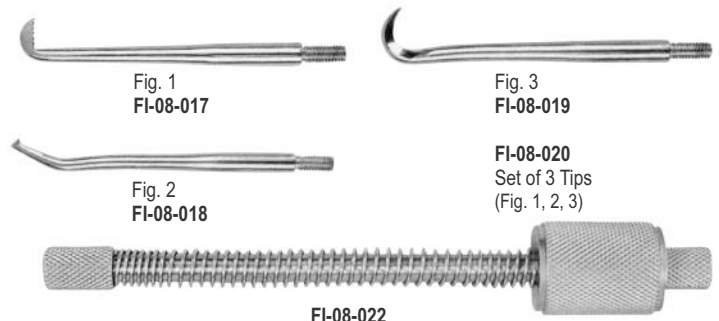
**FI-08-012**  
Contents: 1 Crown Remover, Mounting Kit (Wrench & Key), 3 Tips

Morrel Manual Crown Remover



**FI-08-021**  
Complete with 3 Tips

Morrel Manual Crown Remover with Spring



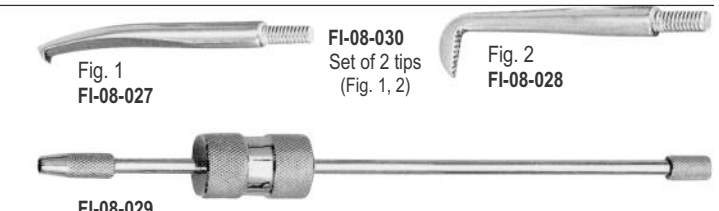
**FI-08-022**  
Complete with 3 Tips

MRU manual crown remover double ended



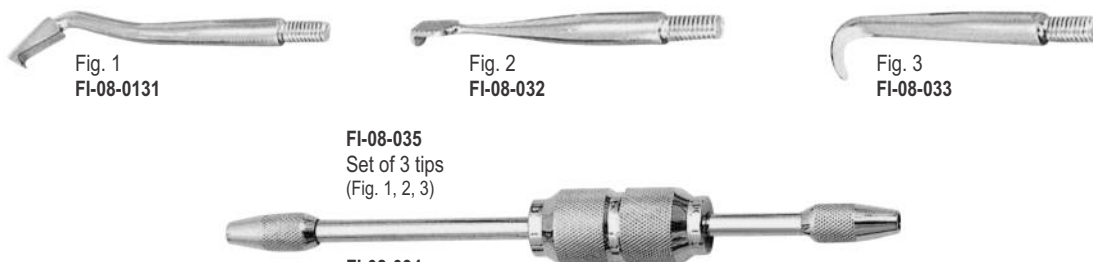
**FI-08-025**  
Complete with 2 tips

MRU manual crown remover single ended



**FI-08-029**  
Complete with 2 tips

MRU manual crown remover double ended



**FI-08-034**  
Complete with 3 tips

**CROWN REMOVERS & CROWN SPREADERS**  
**RIMUOVERE LA CORONA E DIFFONDERE LA CORONA**

Forceps For Articulating Paper

Semi-Automatic Crown & Bridge Remover

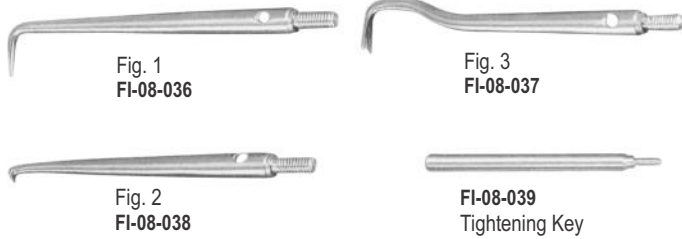


Fig. 1  
FI-08-036

Fig. 3  
FI-08-037

Fig. 2  
FI-08-038

FI-08-039  
Tightening Key

Set of 3 tips & Tightening Key



FI-08-040

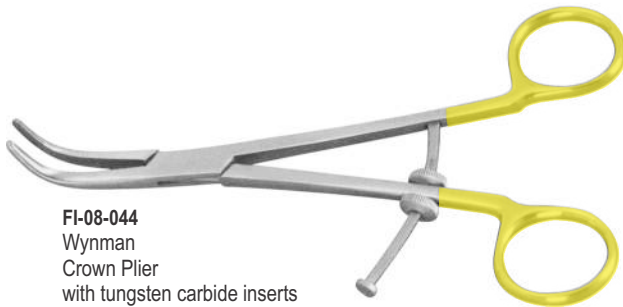
Contents: 1 Crown Remover, Tightening Key, 3 Tips



FI-08-041  
Miller  
15 cm

FI-08-042  
Miller  
15 cm

FI-08-043  
J&W  
15 cm



FI-08-044  
Wynman  
Crown Plier  
with tungsten carbide inserts



FI-08-045  
Furrer Crown Plier  
16 cm



FI-08-046  
Crown spreader



Crown Spreader



Fig. 0  
FI-08-047



Fig. 1  
FI-08-048



Fig. 2  
FI-08-049



Fig. 3  
FI-08-050  
Crown Spreader



**FI-08-051**  
Telescope Crown Plier  
13 cm



**FI-08-052**  
Telescope Crown Plier  
Fine  
15 cm



**FI-08-053**  
Telescope Crown Plier  
Diamond coated  
13 cm



**FI-08-054**  
Telescope Crown Plier  
Diamond coated  
13 cm



**FI-08-055**  
Montfort  
18 cm



**FI-08-056**  
Bohm  
16 cm



**FI-08-057**  
Upper Crown Removing



**FI-08-058**  
Lower Crown Removing



**FI-08-059**  
Upper Crown Removing



**FI-08-060**  
Lower Crown Removing



**FI-08-061**  
 Brewer



**FI-08-062**  
 Ivory



**FI-08-063**  
 Ivory  
 Light Weight



**FI-08-064**  
 Matrix Plier  
 17 cm



**FI-08-065**  
 Stokes



**FI-08-066**  
 Stokes / Palmer



**FI-08-067**  
 Ivory

Rubber Dam Punches



Fig.1  
**FI-08-068**  
 Ainsworth



Fig.2  
**FI-08-069**  
 Ainsworth



Fig. A (14,18A)  
FI-08-070  
Molars, deciduous molars & part erupted teeth.



Fig. AW (14,18A)  
FI-08-071  
Molars with good gingival retraction.



Fig. BW (4,5,8,14)  
FI-08-072  
Molars with good gingival retraction.



Fig. C (6,9,15,212)  
FI-08-073  
Incisors, canines & bicuspid.



Fig. DW (2,7)  
FI-08-074  
Small molars & large bicuspid.



Fig. E (00,0,2,2A,9,15,18A)  
FI-08-075  
All incisors, canines & premolars with limited gingival retraction.



Fig. EW (00,0,2,2A,9,15,18A)  
FI-08-076  
Very stable molar clamp.



Fig. FW (14A)  
FI-08-077  
Very stable molar clamp.



Fig. G (1,2,2A)  
FI-08-078  
Small 3rd molars, deciduous molars, bicuspid & canines.



Fig. GW (14,2A)  
FI-08-079  
Large jaw version of E.



Fig. HW (14W)  
FI-08-080  
Extended arch version of AW.



Fig. JW (26A)  
FI-08-081  
Large molars with deep gingival fit.



Fig. K (3,4,5,7A,8,10,11,26,7,8A)  
FI-08-082  
General winged molar clamp.



Fig. L (0)  
FI-08-083  
Large jaw version of E.



Fig. M (2)  
FI-08-084  
Winged clamp for bicuspid.



Fig. NW  
FI-08-085  
Medium size molar clamp.



Fig. PW (9UW,W5)  
FI-08-086  
Large, bland molar clamp.

Winged  
Premolars



Fig. 00  
FI-08-087



Fig. 0  
FI-08-088



Fig. 1  
FI-08-089



Fig. 2  
FI-08-090



Fig. 2A  
FI-08-091

Winged  
Anterior



Fig. 9  
FI-08-092



Fig. 212  
FI-08-093

Winged  
Molars



Fig. 7  
58-208-07



Fig. 8  
58-208-08



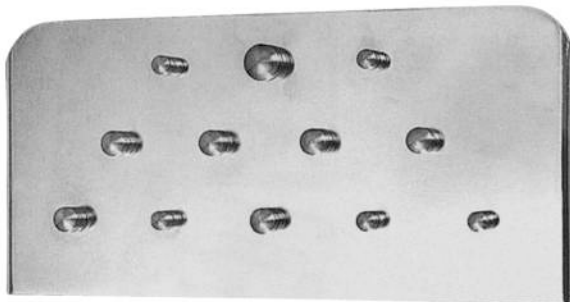
Fig. 8A  
58-208-81



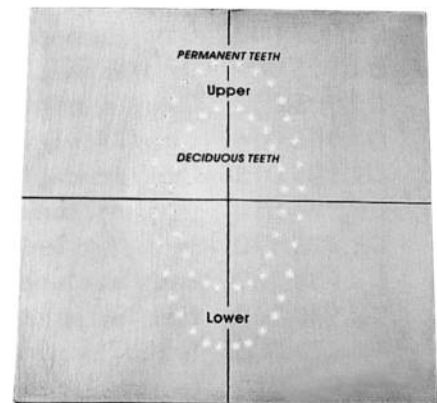
Fig. 14  
58-208-14



Fig. 14A  
58-208-14



FI-08-094  
Rubber Dam Clamps Tray



FI-08-095  
Rubber Dam Template



Matrix bands

Nystrom (Pack of 12)

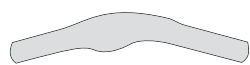


Fig. 2 FI-08-096

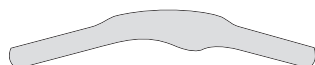


Fig. 4 FI-08-097

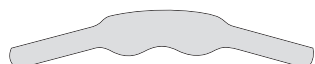


Fig. 5 FI-08-098



Fig. 6 FI-08-099



Fig. 7 FI-08-100

Ivory (Pack of 12)



Fig. 11 FI-08-101  
for children



Fig. 12 FI-08-102  
for children



Fig. 14 FI-08-103



Fig. 15 FI-08-104



Fig. 16 FI-08-105

Tofflemire (pack of 12)



Fig. 101 FI-08-106

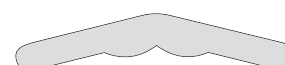


Fig. 102 FI-08-107

Matrix Retainers



FI-08-108  
with cheek protector  
5 mm



Fig. 8  
FI-08-109  
Ivory  
5 mm



Fig. 8  
FI-08-110  
Ivory  
6 mm



Fig. 8  
FI-08-111  
Ivory  
7 mm



FI-08-112  
Tofflemire Junior



FI-08-113  
Tofflemire Senior



FI-08-114  
Tofflemire universal



FI-08-115  
Nystrom  
Left



FI-08-116  
Nystrom  
Right



Fig. 12A  
FI-08-117  
Ivory

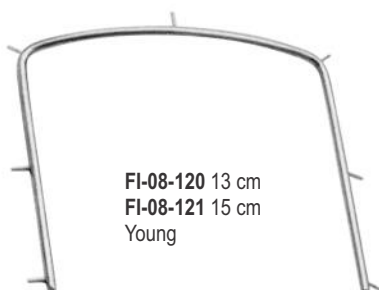


Fig. 12  
FI-08-118  
Ivory

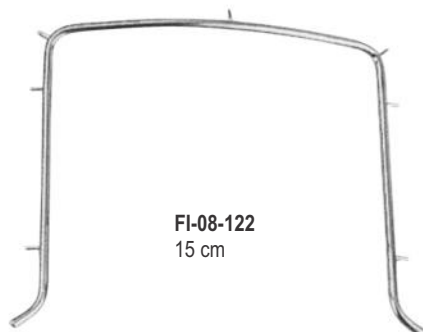


FI-08-119  
Strip clamp  
straight

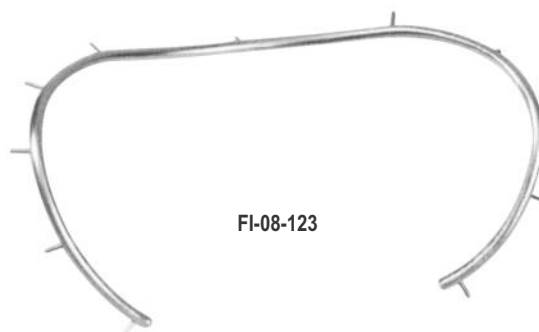
Rubber Dam Frames



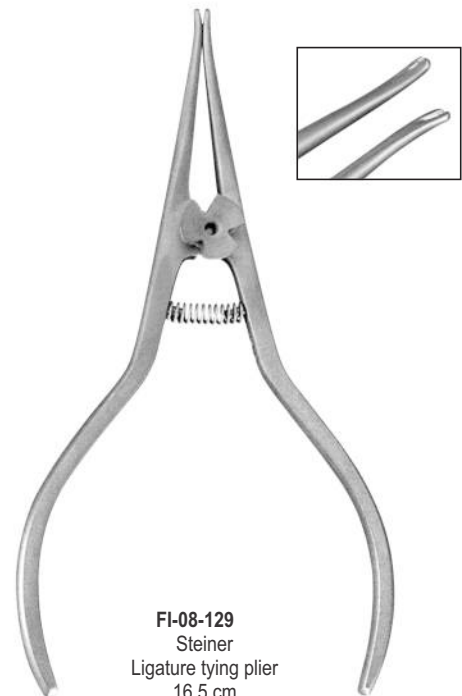
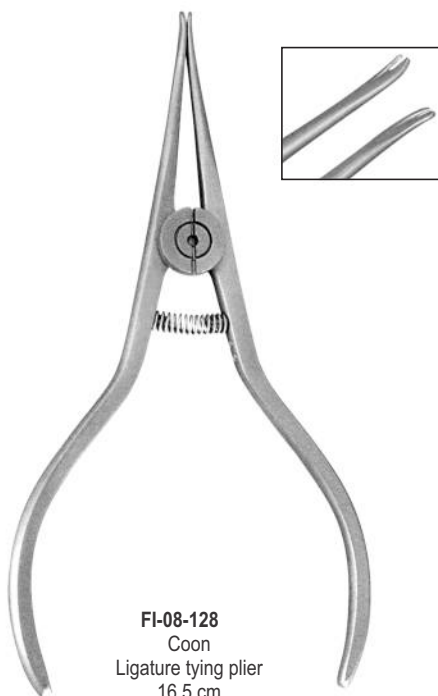
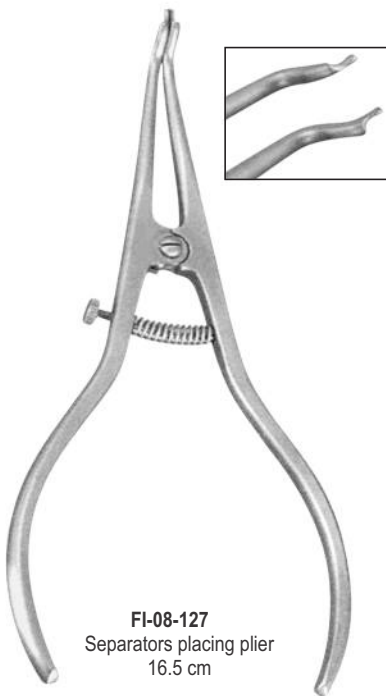
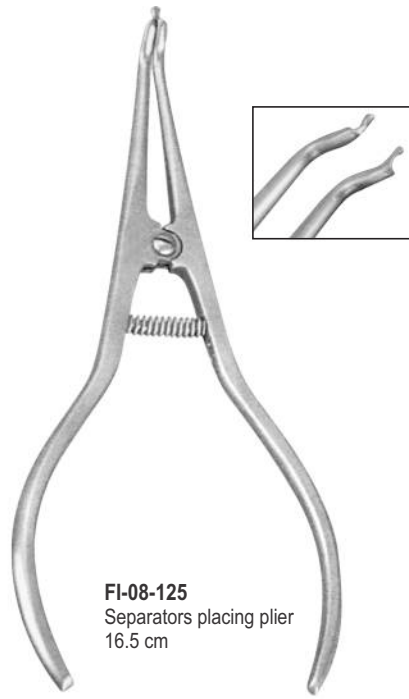
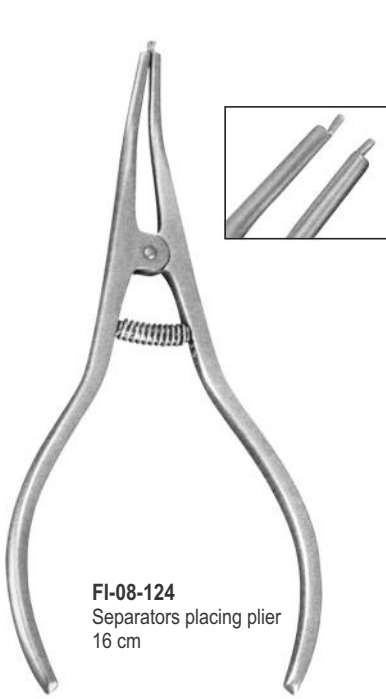
FI-08-120 13 cm  
FI-08-121 15 cm  
Young



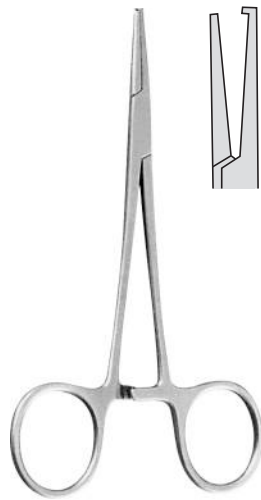
FI-08-122  
15 cm



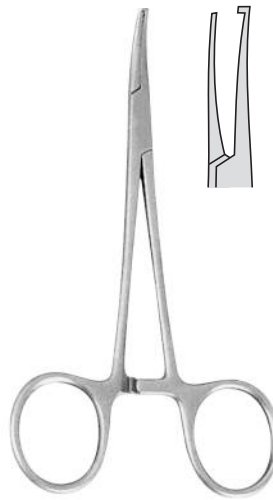
FI-08-123



ELASTIC LIGATURE PLACING FORCEPS  
 PINZA PER POSIZIONAMENTO DI LEGATURA ELASTICA



FI-08-130  
 Str 12 cm



FI-08-131  
 Cvd 12 cm



FI-08-132  
 14 cm



FI-08-133  
 12 cm



FI-08-134  
 14 cm



FI-08-135  
 Elastomeric ligature  
 removing tweezer



Ligature plier  
 14 cm

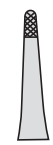


Fig.1  
 FI-08-136



Fig.2  
 FI-08-137



Fig.3  
 FI-08-138



Smaha  
 Ligature plier  
 14 cm



FI-08-139  
 Str



FI-08-140  
 Cvd



FI-08-141  
 Ligature plier  
 14 cm



With tungsten  
 carbide insert

Elastic Ligature Applicators

For easy placement of elastic ligatures under bracket tie wings



FI-08-142



FI-08-143

Elastomeric Ligature Removing Instruments

Multi-purpose instruments, ligature tucker & elastomeric ligature remover



FI-08-144



FI-08-145

Ligature Tuckers

Solid handle



FI-08-146



FI-08-147



FI-08-148



Disc safety guards set  
Protects patients gums, lips and cheeks from rotating discs



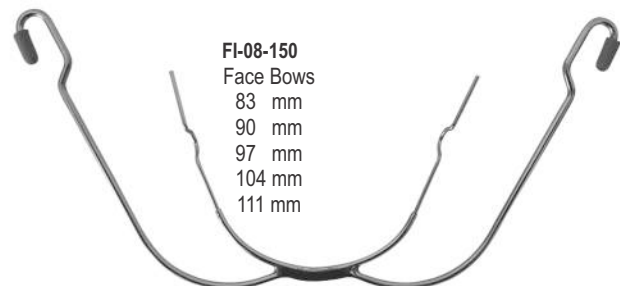
22 mm



16 mm



8 mm



FI-08-150  
Face Bows  
83 mm  
90 mm  
97 mm  
104 mm  
111 mm

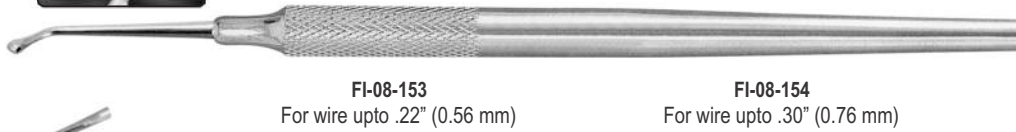
FI-08-149  
Contents  
1 x Shaft  
1 x 8mm Guard  
1 x 16mm Guard  
1 x 22mm Guard

Distal End Bending Instruments



**FI-08-151**  
For wire upto .22" (0.56 mm)

**FI-08-152**  
For wire upto .30" (0.76 mm)



**FI-08-153**  
For wire upto .22" (0.56 mm)

**FI-08-154**  
For wire upto .30" (0.76 mm)

Lingual Torquing Key



**FI-08-155**

NiTi Ice Instrument 11.5 cm



**FI-08-156**

Turns NiTi wire soft and flexible immediately for faster wire placement



Bracket Placer for Posterior Teeth



**FI-08-157**

Reverse action buccal tube tweezer



**FI-08-162** 12.5 cm

**FI-08-163** 13.5 cm

Buccal tube tweezer



**FI-08-164** 12 cm

**FI-08-165** 13.5 cm

Keat

MRU Bracket Positioning Gauges  
Anodized Aluminium



**FI-08-158** For .018" slot brackets



**FI-08-159** For .022" slot brackets

Bracket Placing Tweezers



**FI-08-166** 13.5 cm



**FI-08-167** 13.5 cm



**FI-08-168** 11 cm



**FI-08-160**

Manual interdental stipper handle

Bracket Tweezers with Slot Aligner



**FI-08-169** 13.5 cm

Fig. 1



**FI-08-170** 13.5 cm

Fig. 2



**FI-08-171** 13.5 cm

Fig. 3



**FI-08-161**

Boone

Universal for both .018" or .022" slot brackets  
four different MRU for bracket positioning:  
3.5, 4, 4.5, & 5 mm Stainless Steel



**FI-08-172**  
Band Seater 15 cm



**FI-08-173**  
Mershon band pusher 14 cm



**FI-08-174**  
Band seating



**FI-08-175**  
Molar Band Seater  
14cm

Back view

Scaler & band pushing Instruments  
(6 mm Solid Handles)



**FI-08-176** Director/Pusher



**FI-08-177** Pusher/Scaler # 300S



**FI-08-178** Ligature Director /Scaler



**FI-08-179** Ligature Director D.E



**FI-08-180** Adhesive remover

Measuring Instruments



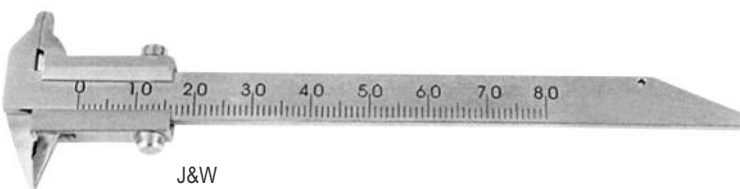
**Bernklau**  
**FI-08-181** Orthodontic ruler  
Perfect for all diagnostic measurements,  
both intraoral and on the model



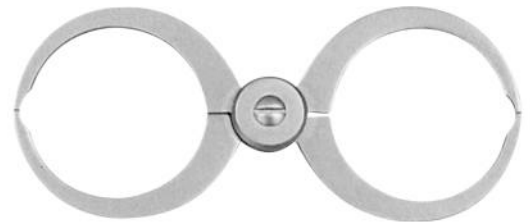
Ruler stainless steel  
**FI-08-182** 15 cm / 6"  
**FI-08-183** 30 cm / 12"



**Beerendonk**  
**FI-08-184**  
Dental vernier with long & fine tips for intraoral measurements



**J&W**  
**FI-08-185**  
Double sided, for inner & outer measurements



Orthodontic bow compass  
**FI-08-186**

Turrets  
For forming archwires, without torque,  
for wires .016" to .022" (0.41mm to 0.56mm)



**FI-08-186**  
Made of Stainless steel



**FI-08-187**  
Made of anodized Aluminum  
Disinfectable

Furnace Tongs



FI-08-188  
31 cm



FI-08-189  
40 cm



FI-08-190  
56 cm



FI-08-191 20 cm Str  
FI-08-192 20 cm Cvd  
Plaster Cutter

Calipers



Fig.1  
FI-08-193  
Boley  
Measuring range  
0-100 mm



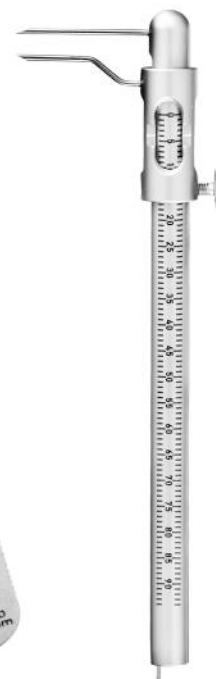
Fig.2  
FI-08-194  
Boley  
Measuring range  
0-100 mm



FI-08-195  
Iwanson for Wax  
Measuring range  
0-10 mm



FI-08-196  
Iwanson for Metal  
Measuring range  
0-10 mm



FI-08-197  
Micro Boley Gauge

Modeling saw & blades



FI-08-198



FI-08-199  
0.25 x 3 mm  
Pack of 12 pcs



FI-08-200  
0.25 x 5 mm  
Pack of 12 pcs



FI-08-201  
0.12 x 5 mm  
Pack of 12 pcs

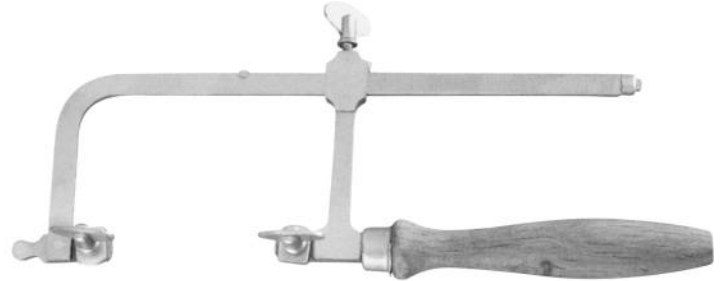


FI-08-202 Soldering Tweezer  
Str 16 cm



FI-08-203  
Soldering Tweezer  
Cvd 16 cm

Fret saw & blades



FI-08-204

FI-08-205  
Saw blades for metal  
Pack of 12 pcs

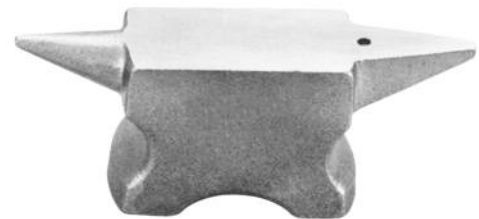
FI-08-206  
Saw blades for plaster  
Pack of 12 pcs



Fig.1  
FI-08-207  
Riveting Mallet 22 cm

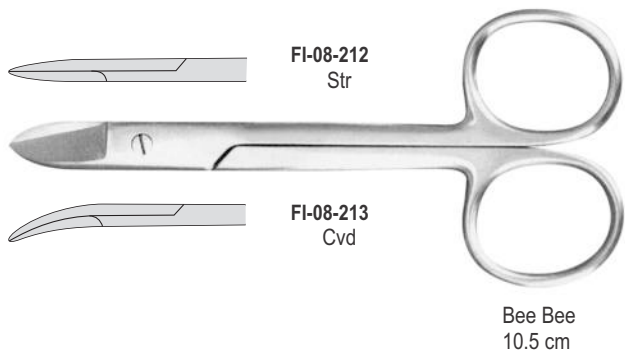
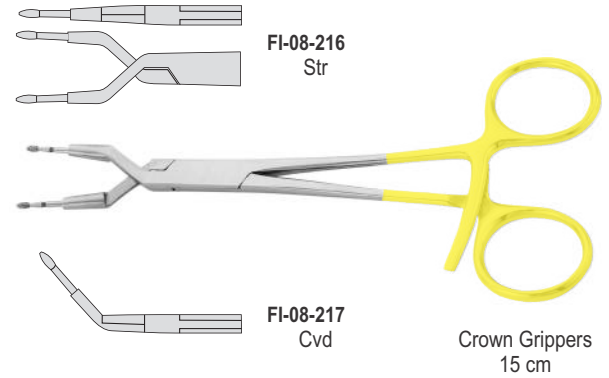
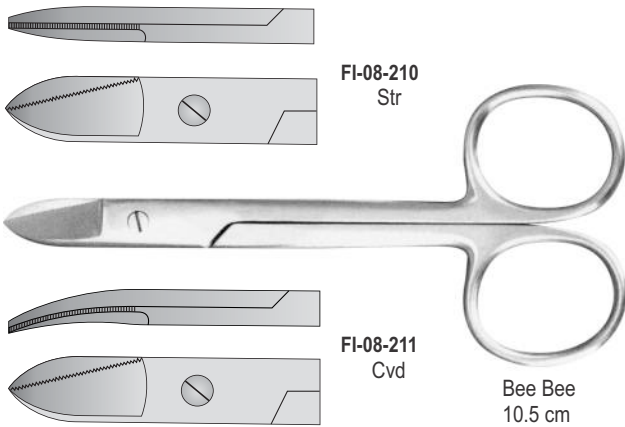


Fig.2  
FI-08-208  
Riveting Mallet 22 cm



FI-08-209  
Anvil  
Carbon Steel  
L 110 x W 30 x H 40 mm





Grinding stones



**FI-08-218**  
Rectangular  
For knives, curettes, scalers etc., medium grit, pink



**FI-08-219**  
Taper round corners  
For knives, curettes, scalers etc., Fine grit, white



**FI-08-220**  
Round  
For curettes, coarse grit, green



**FI-08-221**  
Conical  
For elevators & luxators, fine grit, white

Bib chains



Fig. 1  
FI-08-222  
Ball chain



FI-08-223  
Plastic chain

Bowls for plaster & alginate



Silicone  
Green  
FI-08-224 10 cm  
FI-08-225 12 cm  
FI-08-226 14 cm  
FI-08-227 16 cm



Polyethylene  
White  
FI-08-228 10 cm  
FI-08-229 12 cm  
FI-08-230 14 cm

X-Ray holders



Fig. 1  
FI-08-231



Fig. 6  
FI-08-232  
6 Clips



Fig. 10  
FI-08-233  
10 Clips



Fig. 14  
FI-08-234  
14 Clips



FI-08-235  
Bur Changer  
Square Key



FI-08-236  
Bur Changer  
Hexagonal Key



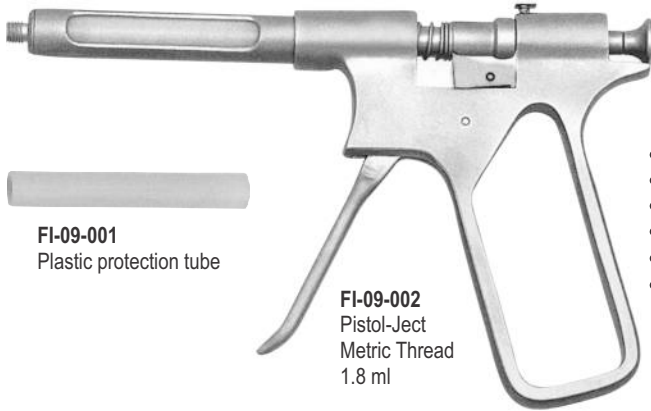
09

Page 134-138

## Dental Syringes

Intraligamental Syringes

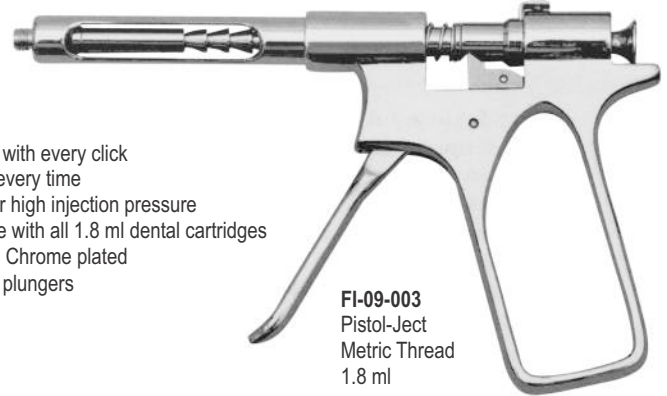
Self & Manual Aspirating Syringes



**FI-09-001**  
Plastic protection tube

**FI-09-002**  
Pistol-Ject  
Metric Thread  
1.8 ml

- Injects 0.02 ml with every click
- Exact dosage every time
- Lever action for high injection pressure
- Suitable for use with all 1.8 ml dental cartridges
- Made of brass, Chrome plated
- Stainless steel plungers



**FI-09-003**  
Pistol-Ject  
Metric Thread  
1.8 ml

### Disc System

#### Dual self aspiration system:

Disc system syringe has dual aspiration feature to achieve self aspiration.

#### Aspiration before injection:

Insert syringe in tissue and press Thumb disc to achieve aspiration.

#### Aspiration during injection:

Automatic aspiration occurs whenever pressure on the plunger is released.



**FI-09-004**  
Disc System  
Metric Thread  
1.8 ml

### Projection System

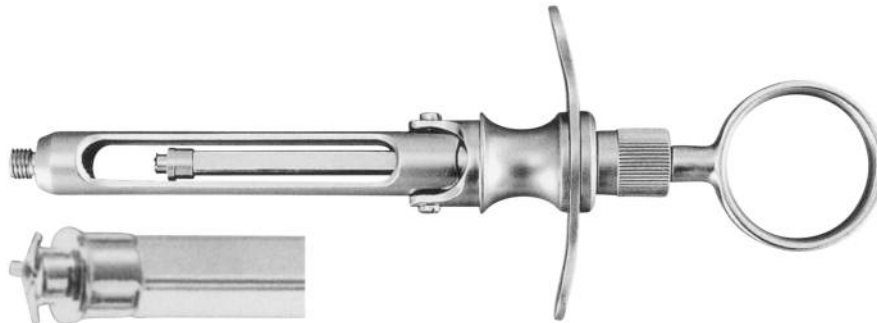
#### Aspiration during injection:

Automatic aspiration occurs whenever pressure on the plunger is released.



**FI-09-005**  
Projection System  
Metric Thread  
1.8 ml

3 movable hooks securely holds the cartridge for safe aspiration, the syringe also has self aspiration feature.



**FI-09-006**  
Trio  
Metric Thread  
1.8 ml

- Made of 18-8 stainless steel
- Longer life than brass syringes
- No chipping of chrome
- Guaranteed quality
- Sterilizable by any method

- Injects 0.05 ml with every click
- Exact dosage every time
- Supplied with angled & straight tubes
- Suitable for use with all 1.8 ml dental cartridges
- Made of stainless steel

- Injects 0.06 ml with every click
- Exact dosage every time
- Suitable for use with all 1.8 ml dental cartridges
- Made of stainless Steel

- Injects 0.06 ml with every click
- Exact dosage every time
- Suitable for use with all 1.8 ml dental cartridges
- Made of stainless Steel

- Injects 0.06 ml with every click
- Exact dosage every time
- Suitable for use with all 1.8 ml dental cartridges
- Made of stainless Steel

- Fully autoclaveable
- Removeable head piece with angled threaded nozzle for the injection needle.
- Viewing chamber with safety sleeve for carpule eartridge.
- Colour coated
- Also available in original Steel colour.



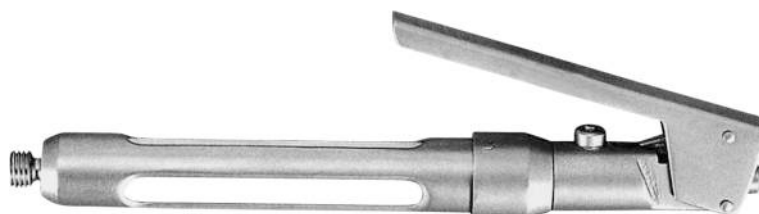
**FI-09-007**  
Metric Thread  
1.8 ml



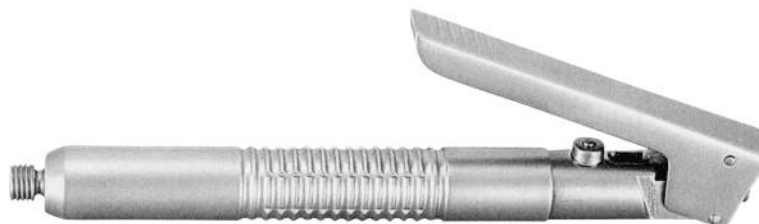
**FI-09-008**  
Angled  
Metric Thread  
1.8 ml



**FI-09-009**  
Straight  
Metric Thread  
1.8 ml



**FI-09-010**  
Swedish Type  
Metric Thread  
1.8 ml



**FI-09-011**  
Intraligamental  
Syringe  
1.8 ml





**FI-09-012**  
Type - A  
Metric Thread  
1.8 ml

Dual aspiration system  
Self and manual aspirating syringes  
During injection aspiration can be achieved either manually by retracting the plunger backward or simply releasing pressure on plunger will produce self aspiration.



**FI-09-013**  
Type - C  
Metric Thread  
1.8 ml

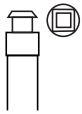
### Manual Aspirating Syringes



**FI-09-014**  
Type - A  
Metric Thread  
1.8 ml



**FI-09-015**  
Type - C  
Metric Thread  
1.8 ml



Special aspiration tip for use with 1.8 ml cartridges with hole.  
(May also be used with traditional cartridges. (without aspiration).

**FI-09-016**  
P - Ject  
Metric Thread  
1.8 ml



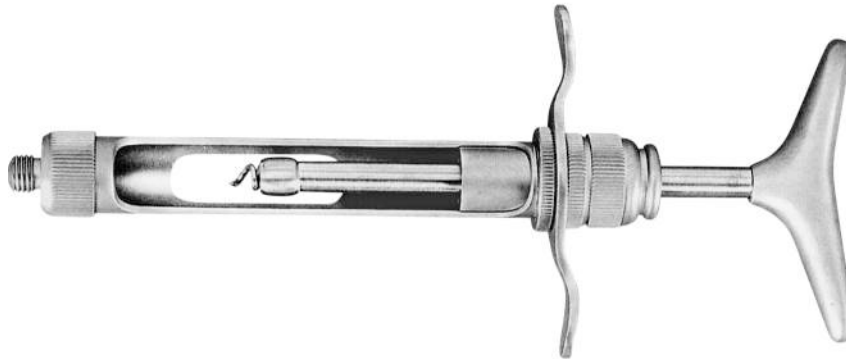
**FI-09-017**  
Type - A  
Metric Thread  
1.8 ml



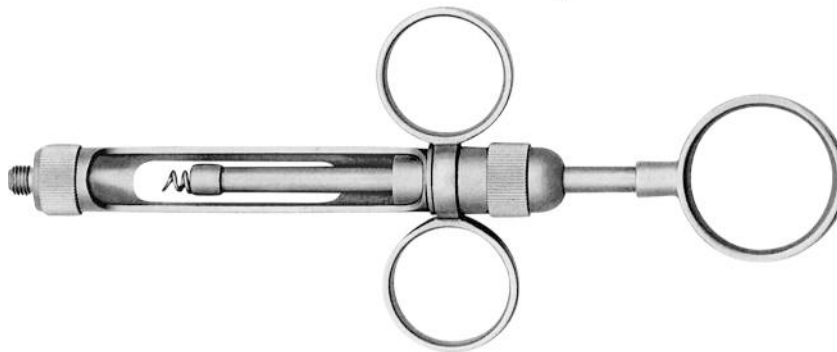
**FI-09-018**  
Euro  
Metric Thread  
1.8 ml



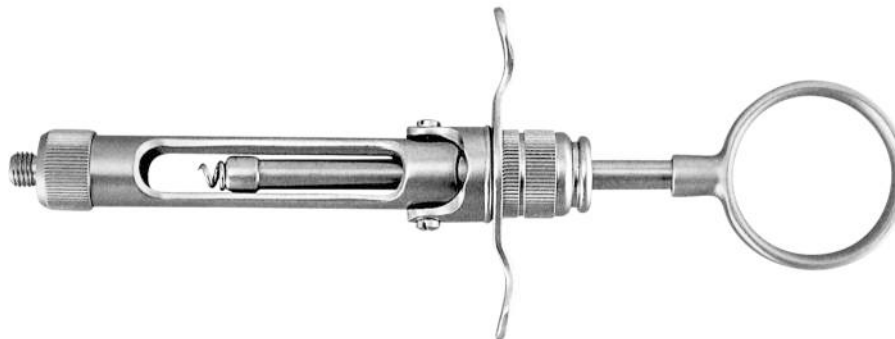
**FI-09-019**  
Euro  
Metric Thread  
1.8 ml



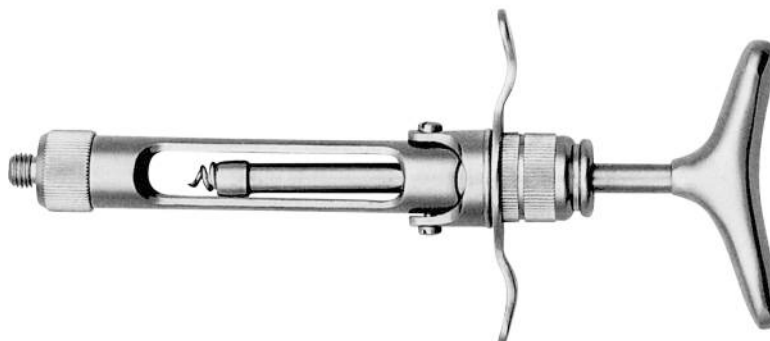
**FI-09-020**  
T - Handle  
Metric Thread  
1.8 ml



**FI-09-021**  
3 - Ring  
Metric Thread  
1.8 ml



**FI-09-022**  
Euro breech loading, Ring handle  
Metric Thread  
1.8 ml



**FI-09-023**  
Euro breech loading, T - handle  
Metric Thread  
1.8 ml



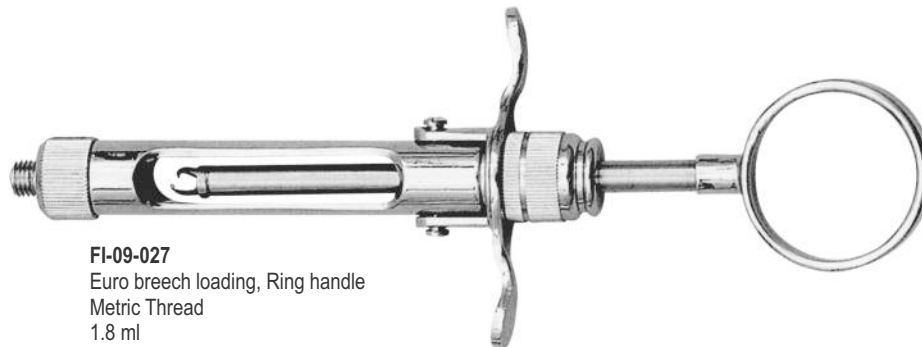
**FI-09-024**  
 Euro  
 Metric Thread  
 1.8 ml



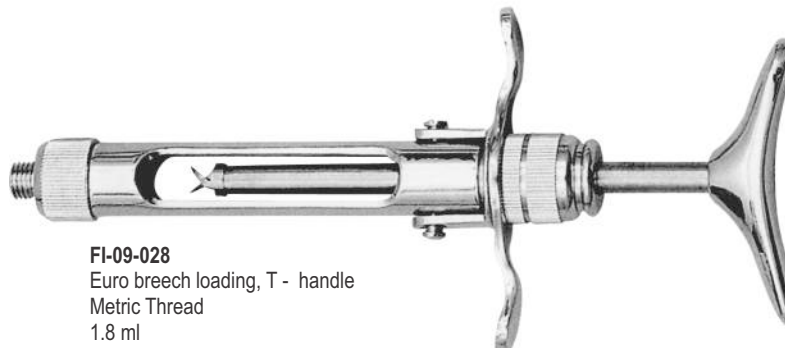
**FI-09-025**  
 3 - Ring  
 Metric Thread  
 1.8 ml



**FI-09-026**  
 2 - Ring  
 Metric Thread  
 1.8 ml



**FI-09-027**  
 Euro breech loading, Ring handle  
 Metric Thread  
 1.8 ml



**FI-09-028**  
 Euro breech loading, T - handle  
 Metric Thread  
 1.8 ml





10

Page 139-143

## Impression Trays

Impression Trays (Solid & Perforated)

Made of High Quality Non-Magnetic Stainless Steel (AISI 304). Micro Etched Inner Surface For Better Retention

Blue Clear Green Red Purple Yellow

### Perforated with Rim



Fig. 30  
FI-10-001  
Upper Left / Lower Right

Fig. 31  
FI-10-002  
Lower Left / Upper Right

Fig. 32  
FI-10-003  
Lower Jaw

Fig. 33  
FI-10-004  
Upper Jaw

Fig. 99  
FI-10-005  
Lateral

### Solid with Rim



Fig. 30  
FI-10-006  
Upper Left / Lower Right

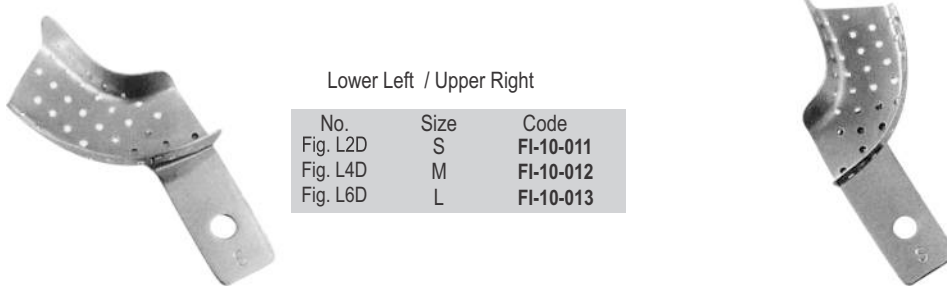
Fig. 31  
FI-10-007  
Lower Left / Upper Right

Fig. 32  
FI-10-008  
Lower Jaw

Fig. 33  
FI-10-009  
Upper Jaw

Fig. 99  
FI-10-010  
Lateral

### Perforated without Rim



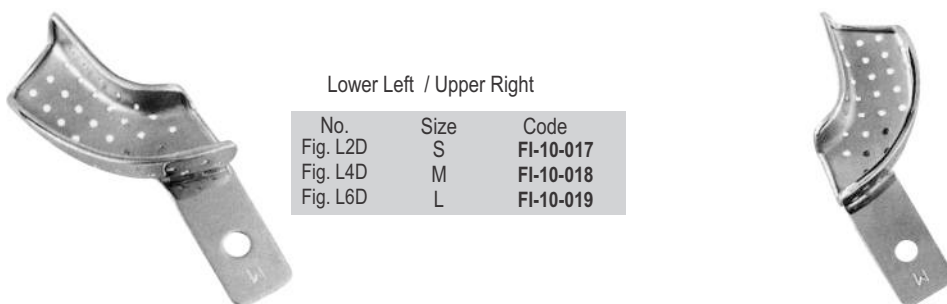
Lower Left / Upper Right

No.	Size	Code
Fig. L2D	S	FI-10-011
Fig. L4D	M	FI-10-012
Fig. L6D	L	FI-10-013

Upper Left / Lower Right

No.	Size	Code
Fig. L2S	S	FI-10-014
Fig. L4S	M	FI-10-015
Fig. L6S	L	FI-10-016

### Perforated with Rim



Lower Left / Upper Right

No.	Size	Code
Fig. L2D	S	FI-10-017
Fig. L4D	M	FI-10-018
Fig. L6D	L	FI-10-019

Upper Left / Lower Right

No.	Size	Code
Fig. L2S	S	FI-10-020
Fig. L4S	M	FI-10-021
Fig. L6S	L	FI-10-022

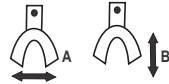
Made of High Quality Non-Magnetic Stainless Steel (AISI 304). Micro Etched Inner Surface For Better Retention

Silicone buttons for impression trays  
Fit any impression tray. Easy identification of size

Perforated without Rim



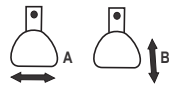
Lower



No.	Size	A mm	B mm	Code
L1	XXS	55	47	FI-10-023
L2	XS	60	49	FI-10-024
L3	S	72	54	FI-10-025
L4	M	74	57	FI-10-026
L5	L	76	59	FI-10-027
L6	XL	78	61	FI-10-028



Upper



No.	Size	A mm	B mm	Code
U1	XXS	61	47	FI-10-029
U2	XS	64	51	FI-10-030
U3	S	66	53	FI-10-031
U4	M	69	57	FI-10-032
U5	L	71	60	FI-10-033
U6	XL	73	62	FI-10-034

Set	Contents	Code
6 Pcs	L3,L4,L5,U3,U4,U5	FI-10-035
8 Pcs	L3,L4,L5,L6,U3,U4,U5,U6	FI-10-036
12 Pcs	L1,L2,L3,L4,L5,L6 U1,U2,U3,U4,U5,U6	FI-10-037

Perforated with Rim



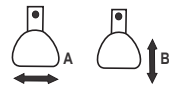
Lower



No.	Size	A mm	B mm	Code
L1	XXS	55	47	FI-10-053
L2	XS	60	49	FI-10-054
L3	S	72	54	FI-10-055
L4	M	74	57	FI-10-056
L5	L	76	59	FI-10-057
L6	XL	78	61	FI-10-058



Upper



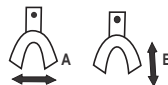
No.	Size	A mm	B mm	Code
U1	XXS	61	47	FI-10-059
U2	XS	64	51	FI-10-060
U3	S	66	53	FI-10-061
U4	M	69	57	FI-10-062
U5	L	71	60	FI-10-063
U6	XL	73	62	FI-10-064

Set	Contents	Code
6 Pcs	L3,L4,L5,U3,U4,U5	FI-10-065
8 Pcs	L3,L4,L5,L6,U3,U4,U5,U6	FI-10-066
12 Pcs	L1,L2,L3,L4,L5,L6 U1,U2,U3,U4,U5,U6	FI-10-067

Solid without Rim



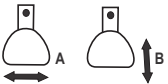
Lower



No.	Size	A mm	B mm	Code
L1	XXS	55	47	FI-10-038
L2	XS	60	49	FI-10-039
L3	S	72	54	FI-10-040
L4	M	74	57	FI-10-041
L5	L	76	59	FI-10-042
L6	XL	78	61	FI-10-043



Upper



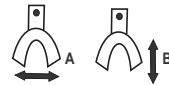
No.	Size	A mm	B mm	Code
U1	XXS	61	47	FI-10-044
U2	XS	64	51	FI-10-045
U3	S	66	53	FI-10-046
U4	M	69	57	FI-10-047
U5	L	71	60	FI-10-048
U6	XL	73	62	FI-10-049

Set	Contents	Code
6 Pcs	L3,L4,L5,U3,U4,U5	FI-10-050
8 Pcs	L3,L4,L5,L6,U3,U4,U5,U6	FI-10-051
12 Pcs	L1,L2,L3,L4,L5,L6 U1,U2,U3,U4,U5,U6	FI-10-052

Solid with Rim



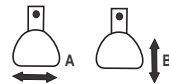
Lower



No.	Size	A mm	B mm	Code
L1	XXS	55	47	FI-10-068
L2	XS	60	49	FI-10-069
L3	S	72	54	FI-10-070
L4	M	74	57	FI-10-071
L5	L	76	59	FI-10-072
L6	XL	78	61	FI-10-073



Upper



No.	Size	A mm	B mm	Code
U1	XXS	61	47	FI-10-074
U2	XS	64	51	FI-10-075
U3	S	66	53	FI-10-076
U4	M	69	57	FI-10-077
U5	L	71	60	FI-10-078
U6	XL	73	62	FI-10-079

Set	Contents	Code
6 Pcs	L3,L4,L5,U3,U4,U5	FI-10-080
8 Pcs	L3,L4,L5,L6,U3,U4,U5,U6	FI-10-081
12 Pcs	L1,L2,L3,L4,L5,L6 U1,U2,U3,U4,U5,U6	FI-10-082

Made of High Quality Non-Magnetic Stainless Steel (AISI 304).  
Micro Etched Inner Surface For Better Retention

### Perforated with Rim



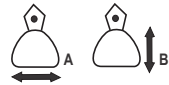
Lower



Upper



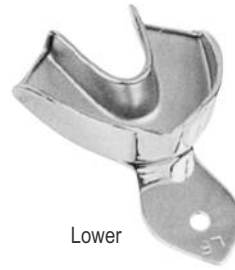
No.	Size	A mm	B mm	Code
L1	XL	80	63	FI-10-083
L2	L	78	59	FI-10-084
L3	M	76	57	FI-10-085
L4	NM	72	57	FI-10-086
L5	S	69	50	FI-10-087



No.	Size	A mm	B mm	Code
U1	XL	81	63	FI-10-088
U2	L	74	60	FI-10-089
U3	M	71	55	FI-10-090
U4	NM	67	53	FI-10-091
U5	S	65	51	FI-10-092

Set	Contents	Code
6 Pcs	L2,L3,L4,U2,U3,U4	FI-10-093
10 Pcs	L1,L2,L3,L4,L5 U1,U2,U3,U4,U5	FI-10-094

### Impression Trays Regular

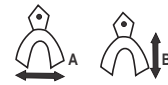


Lower

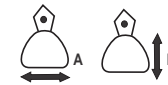


Upper

### Solid with Rim



No.	Size	A mm	B mm	Code
L1	XL	80	63	FI-10-108
L2	L	78	59	FI-10-109
L3	M	76	57	FI-10-110
L4	NM	72	57	FI-10-111
L5	S	69	50	FI-10-112



No.	Size	A mm	B mm	Code
U1	XL	81	63	FI-10-113
U2	L	74	60	FI-10-114
U3	M	71	55	FI-10-115
U4	NM	67	53	FI-10-116
U5	S	65	51	FI-10-117

Set	Contents	Code
6 Pcs	L2,L3,L4,U2,U3,U4	FI-10-118
10 Pcs	L1,L2,L3,L4,L5 U1,U2,U3,U4,U5	FI-10-119

### Impression Trays For Children

#### Perforated with Rim



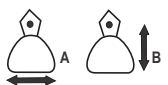
Lower



Upper



No.	Size	A mm	B mm	Code
L1	S	54	47	FI-10-095
L2	M	62	51	FI-10-096
L3	L	70	55	FI-10-097



No.	Size	A mm	B mm	Code
U1	S	55	43	FI-10-098
U2	M	60	45	FI-10-099
U3	L	63	49	FI-10-100

Set	Contents	Code
6 Pcs	L1,L2,L3,U1,U2,U3	FI-10-101



Lower

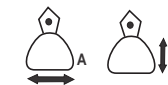


Upper

#### Solid with Rim



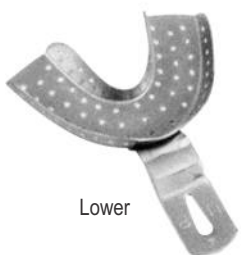
No.	Size	A mm	B mm	Code
L1	S	54	47	FI-10-120
L2	M	62	51	FI-10-121
L3	L	70	55	FI-10-122



No.	Size	A mm	B mm	Code
U1	S	55	43	FI-10-123
U2	M	60	45	FI-10-124
U3	L	63	49	FI-10-125

Set	Contents	Code
6 Pcs	L1,L2,L3,U1,U2,U3	FI-10-126

### Impression Trays Regular Ehrlicke Pattern Perforated



Lower

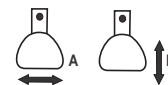


No.	Size	A mm	B mm	Code
Ub0	XS	65	46	FI-10-102
UB1	S	67	50	FI-10-103
UB2	M	76	54	FI-10-104
UB3	L	79	56	FI-10-105
UB4	XL	79	61	FI-10-106

Set	Contents	Code
10 Pcs	UB0,UB1,UB2,UB3,UB4, OB0,OB1,OB2,OB3,OB4	FI-10-107



Upper



No.	Size	A mm	B mm	Code
OB0	XS	59	52	FI-10-127
OB1	S	66	52	FI-10-128
OB2	M	71	62	FI-10-129
OB3	L	71	64	FI-10-130
OB4	XL	80	70	FI-10-131

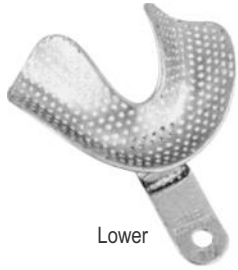
Set	Contents	Code
10 Pcs	UB0,UB1,UB2,UB3,UB4, OB0,OB1,OB2,OB3,OB4	FI-10-132

Made of High Quality Non-Magnetic Stainless Steel (AISI 304).  
Micro Etched Inner Surface For Better Retention

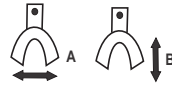
Perforated with Rim

Impression Trays Edentulous

Solid with Rim



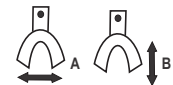
Lower



No.	Size	A mm	B mm	Code
L1	XL	84	65	FI-10-133
L2	L	77	64	FI-10-134
L3	M	76	60	FI-10-135
L4	S	68	57	FI-10-136



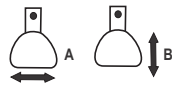
Lower



No.	Size	A mm	B mm	Code
L1	XL	84	65	FI-10-152
L2	L	77	64	FI-10-153
L3	M	76	60	FI-10-154
L4	S	68	57	FI-10-155



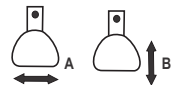
Upper



No.	Size	A mm	B mm	Code
U1	XL	80	62	FI-10-137
U2	L	77	60	FI-10-138
U3	M	70	60	FI-10-139
U4	S	72	56	FI-10-140



Upper



No.	Size	A mm	B mm	Code
U1	XL	80	62	FI-10-156
U2	L	77	60	FI-10-157
U3	M	70	60	FI-10-158
U4	S	72	56	FI-10-159

Set	Contents	Code
8 Pcs	L1,L2,L3,L4,U1,U2,U3,U4	FI-10-141

Set	Contents	Code
8 Pcs	L1,L2,L3,L4,U1,U2,U3,U4	FI-10-160

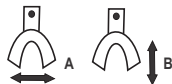
Perforated with Rim

Impression Trays Anterior Depressed

Solid with Rim



Lower



No.	Size	A mm	B mm	Code
L1	S	65	48	FI-10-142
L2	M	72	57	FI-10-143
L3	L	75	57	FI-10-144



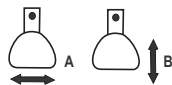
Lower



No.	Size	A mm	B mm	Code
L1	S	65	48	FI-10-161
L2	M	72	57	FI-10-162
L3	L	75	57	FI-10-163



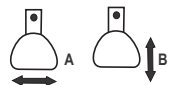
Upper



No.	Size	A mm	B mm	Code
U1	S	64	56	FI-10-145
U2	M	67	60	FI-10-146
U3	L	72	63	FI-10-147



Upper



No.	Size	A mm	B mm	Code
U1	S	64	56	FI-10-164
U2	M	67	60	FI-10-165
U3	L	72	63	FI-10-166

Set	Contents	Code
6 Pcs	L1,L2,L3,U1,U2,U3	FI-10-148

Set	Contents	Code
6 Pcs	L1,L2,L3,U1,U2,U3	FI-10-167

Impression Trays Edentulous Ehrlicke Pattern Perforated



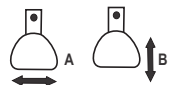
Lower



No.	Size	A mm	B mm	Code
UU1	S	70	48	FI-10-149
UU2	M	70	53	FI-10-150
UU3	L	72	57	FI-10-151



Upper



No.	Size	A mm	B mm	Code
OU1	S	64	46	FI-10-168
OU2	M	68	53	FI-10-169
OU3	L	79	61	FI-10-170

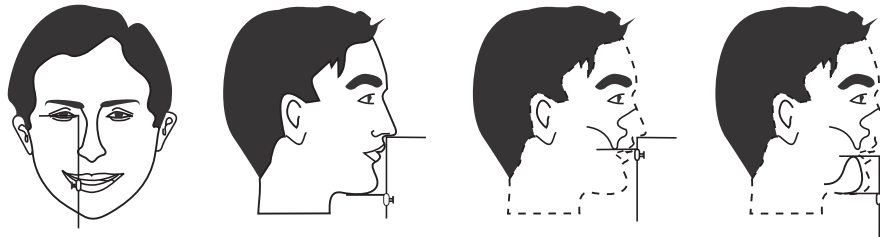
Set	Contents	Code
6 Pcs	UU1,UU2,UU3,OU1,OU2,OU3	FI-10-171

Bite Gauge

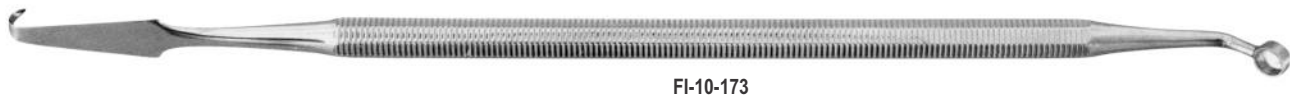
A simple measuring instrument as an aid in the re-establishment of correct facial contour during full or partial denture work.



Slide B is fully adjustable and reversible along shaft A and may be fixed at any position by means of its locking-screw as shown.



Carvers for silicone impression materials



FI-10-173

Hollow handle



FI-10-174

Gingival cord packers



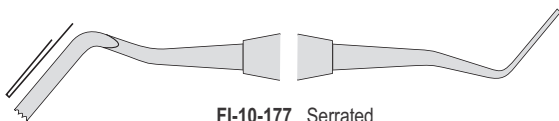
FI-10-175

Serrated

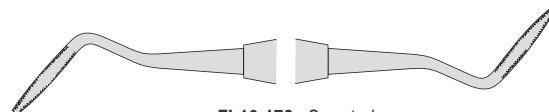


FI-10-176

Smooth



FI-10-177 Serrated



FI-10-178 Serrated



11

Page 144-154

## Crown Removers

Crown Removers & Forceps for Articulating Paper

Crown Spreaders

Rubber Dam Instruments

Matrix Retainers & Rubber Dam Frames

Ligature & Separators Placing Pliers

Elastic Ligature Placing Forceps

Elastic Applicators & Ligature Tuckers

Bracket Positioning Instruments

Bracket & Measuring Instruments

Laboratory Instruments

Crown Instruments & Grinding Stones

X - Ray Holders & Laboratory Bowls



Instruments Trays

FI-11-001	210 x 160 x 10 mm
FI-11-002	240 x 180 x 10 mm
FI-11-003	310 x 150 x 10 mm
FI-11-004	310 x 210 x 10 mm
FI-11-005	350 x 240 x 10 mm
FI-11-006	400 x 270 x 10 mm
FI-11-007	420 x 280 x 10 mm

Mayo Trays Perforated

FI-11-008	150 x 100 x 50 mm
FI-11-009	200 x 100 x 50 mm
FI-11-010	220 x 120 x 50 mm
FI-11-011	240 x 140 x 50 mm
FI-11-012	200 x 150 x 50 mm
FI-11-013	250 x 200 x 50 mm
FI-11-014	300 x 200 x 50 mm
FI-11-015	300 x 250 x 50 mm
FI-11-016	350 x 250 x 50 mm
FI-11-017	400 x 300 x 50 mm
FI-11-018	450 x 300 x 50 mm
FI-11-019	450 x 350 x 50 mm



DIN Baskets perforated sides

FI-11-020	240 x 240 x 50 mm
FI-11-021	240 x 240 x 100 mm
FI-11-022	480 x 260 x 50 mm
FI-11-023	520 x 260 x 80 mm
FI-11-024	520 x 260 x 100 mm

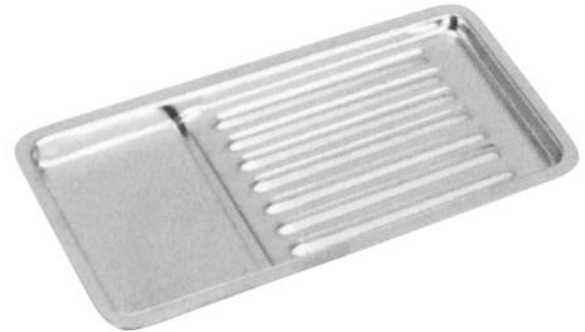
Wiremesh Baskets perforated

FI-11-025	240 x 240 x 50 mm
FI-11-026	260 x 240 x 100 mm
FI-11-027	480 x 260 x 50 mm
FI-11-028	520 x 260 x 80 mm
FI-11-029	520 x 260 x 100 mm





Scalers Trays	
FI-11-030	190 x 100 x 17 mm
FI-11-031	200 x 100 x 25 mm



Scalers Trays	
FI-11-032	185 x 80 x 15 mm

FI-11-041



Instruments Trays With LID	
FI-11-033	150 x 100 x 50 mm
FI-11-034	200 x 100 x 50 mm
FI-11-035	220 x 120 x 50 mm
FI-11-036	240 x 140 x 50 mm
FI-11-037	200 x 150 x 50 mm
FI-11-038	250 x 200 x 50 mm
FI-11-039	300 x 250 x 50 mm
FI-11-040	300 x 200 x 50 mm
FI-11-041	350 x 250 x 50 mm
FI-11-042	400 x 300 x 50 mm
FI-11-043	450 x 300 x 50 mm
FI-11-044	450 x 350 x 50 mm



Instruments Trays Without LID	
FI-11-045	150 x 100 x 50 mm
FI-11-046	200 x 100 x 50 mm
FI-11-047	220 x 120 x 50 mm
FI-11-048	240 x 140 x 50 mm
FI-11-049	200 x 150 x 50 mm
FI-11-050	250 x 200 x 50 mm
FI-11-051	300 x 250 x 50 mm
FI-11-052	300 x 200 x 50 mm
FI-11-053	350 x 250 x 50 mm
FI-11-054	400 x 300 x 50 mm
FI-11-055	450 x 300 x 50 mm
FI-11-056	450 x 350 x 50 mm



Instrument Boxes With Side Handle

FI-11-057	150 x 100 x 50 mm
FI-11-058	200 x 100 x 50 mm
FI-11-059	220 x 120 x 50 mm
FI-11-060	240 x 140 x 50 mm
FI-11-061	200 x 150 x 50 mm
FI-11-062	250 x 200 x 50 mm
FI-11-063	300 x 200 x 50 mm
FI-11-064	300 x 250 x 50 mm
FI-11-065	400 x 300 x 50 mm
FI-11-066	450 x 300 x 50 mm
FI-11-067	450 x 350 x 50 mm



Instrument Boxes With LID

FI-11-068	150 x 100 x 50 mm
FI-11-069	200 x 100 x 50 mm
FI-11-070	220 x 120 x 50 mm
FI-11-071	240 x 140 x 50 mm
FI-11-072	200 x 150 x 50 mm
FI-11-073	250 x 200 x 50 mm
FI-11-074	300 x 200 x 50 mm
FI-11-075	300 x 250 x 50 mm
FI-11-076	400 x 300 x 50 mm
FI-11-077	400 x 300 x 50 mm
FI-11-078	450 x 350 x 50 mm



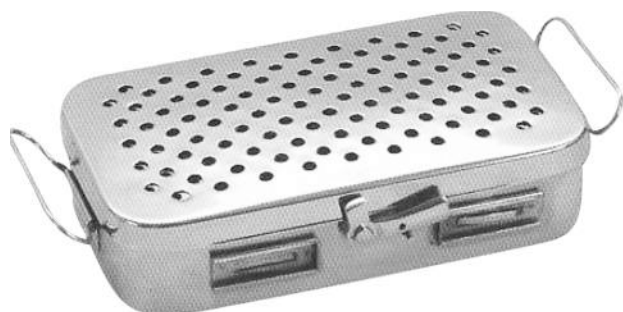
Perforated Instruments Boxes

FI-11-079	170 x 070 x 35 mm
FI-11-080	180 x 080 x 40 mm
FI-11-081	200 x 100 x 40 mm
FI-11-082	200 x 100 x 50 mm
FI-11-083	200 x 100 x 60 mm
FI-11-084	220 x 120 x 60 mm
FI-11-085	250 x 120 x 60 mm
FI-11-086	300 x 150 x 60 mm
FI-11-087	300 x 200 x 80 mm
FI-11-088	400 x 160 x 80 mm
FI-11-089	400 x 200 x 100 mm
FI-11-090	500 x 200 x 120 mm



Perforated Instruments Boxes

FI-11-091	170 x 070 x 35 mm
FI-11-092	180 x 080 x 40 mm
FI-11-093	200 x 100 x 40 mm
FI-11-094	200 x 100 x 50 mm
FI-11-095	200 x 100 x 60 mm
FI-11-096	220 x 120 x 60 mm
FI-11-097	250 x 120 x 60 mm
FI-11-098	300 x 150 x 60 mm
FI-11-099	300 x 200 x 80 mm
FI-11-100	400 x 160 x 80 mm
FI-11-101	400 x 200 x 100 mm
FI-11-102	500 x 200 x 120 mm



Instruments Boxes Perforated

FI-11-103	180 x 80 x 30 mm
FI-11-104	180 x 80 x 40 mm
FI-11-105	180 x 80 x 50 mm
FI-11-106	200 x 90 x 30 mm
FI-11-107	200 x 90 x 40 mm
FI-11-108	200 x 90 x 50 mm
FI-11-109	250 x 100 x 40 mm
FI-11-110	250 x 100 x 50 mm
FI-11-111	250 x 100 x 60 mm



Catheter trays with cover

FI-11-112	100 x 200 x 50 mm
FI-11-113	100 x 300 x 50 mm
FI-11-114	120 x 220 x 50 mm



Instruments Boxes With Filters

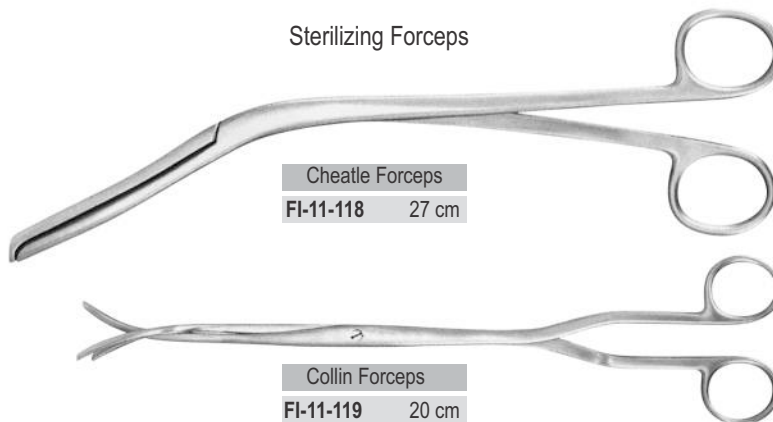
FI-11-115	170 x 070 x 35 mm
FI-11-116	180 x 080 x 40 mm
FI-11-117	200 x 100 x 40 mm
FI-11-118	200 x 100 x 50 mm
FI-11-119	200 x 100 x 60 mm
FI-11-110	220 x 120 x 60 mm
FI-11-111	250 x 120 x 60 mm
FI-11-112	300 x 150 x 60 mm
FI-11-113	300 x 200 x 80 mm
FI-11-114	400 x 160 x 80 mm
FI-11-115	400 x 200 x 100 mm
FI-11-116	500 x 200 x 120 mm



Thermometer Jar

	dia. height
FI-11-117	Ø 25 x 100 mm

Sterilizing Forceps

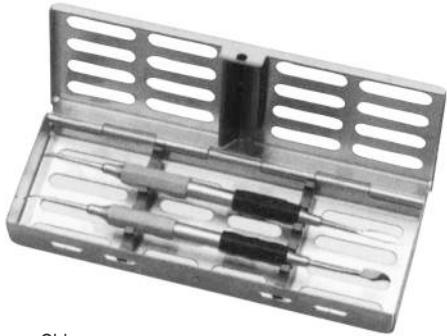


Cheatle Forceps

FI-11-118	27 cm
-----------	-------

Collin Forceps

FI-11-119	20 cm
FI-11-120	30 cm



Chico  
Stainless Steel for 5 instruments  
FI-11-121 180 x 60 x 22 mm



Medio  
Stainless Steel for 10 instruments  
FI-11-122 180 x 125 x 22 mm



Maxi  
Stainless Steel for 20 instruments  
FI-11-123 280 x 180 x 25 mm



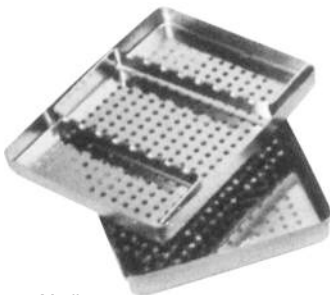
Maxi Set 1  
Stainless Steel rack for 15 instruments  
FI-11-124 288 x 187 x 40 mm



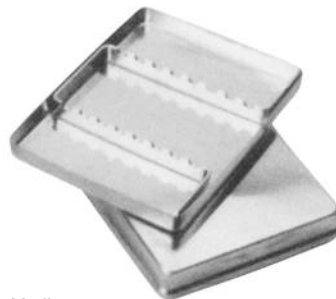
Maxi Set 2  
Stainless Steel for 15 instruments  
FI-11-125 288 x 187 x 40 mm



Maxi Set 3  
Stainless Steel for 15 instruments  
FI-11-126 288 x 187 x 40 mm



Medio  
Stainless Steel Perforated Tray with cover  
FI-11-127 187 x 145 x 25 mm



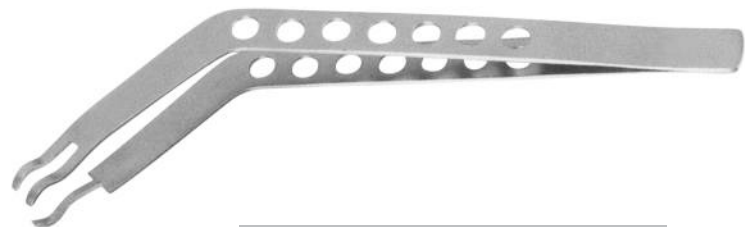
Medio  
Stainless Steel Solid Tray with cover  
FI-11-128 187 x 145 x 25 mm



Burs Disinfecting Box Stainless Steel  
FI-11-129 90 mm x 40 mm



Mesh Burs Holder  
FI-11-130 35 mm x 150 mm

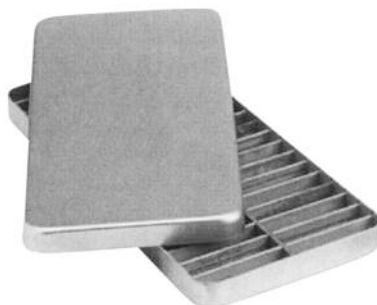


FI-11-131 Bur Holding Tweezer 16.5 cm



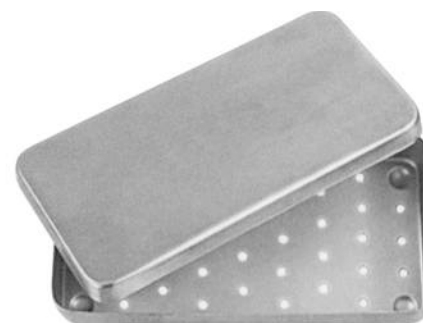
Perforated Instruments Boxes

FI-11-132	170 x 070 x 35 mm
FI-11-133	180 x 080 x 40 mm
FI-11-134	200 x 100 x 40 mm
FI-11-135	200 x 100 x 50 mm
FI-11-136	200 x 100 x 60 mm
FI-11-137	220 x 120 x 60 mm
FI-11-138	250 x 120 x 60 mm
FI-11-139	300 x 150 x 60 mm
FI-11-140	300 x 200 x 80 mm
FI-11-141	400 x 160 x 80 mm
FI-11-142	400 x 200 x 100 mm
FI-11-143	500 x 200 x 120 mm



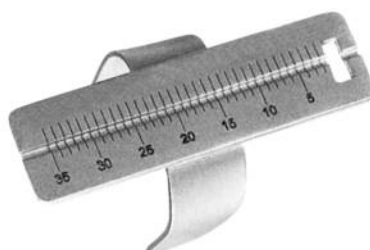
Stainless Steel endodontic tray with cover

FI-11-144 250 x 115 x 15 mm



Instrument Box perforated

FI-11-145 180 x 90 x 30 mm



FI-11-146 Endometer Laser etched



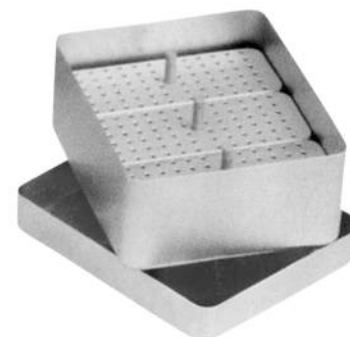
FI-11-147 Lester Pumice Cup



FI-11-148 Endo Box Round



FI-11-149 Endo Box



FI-11-150 Endo Box Trio



FI-11-151 Cotton Holder with Lid



FI-11-152 Cotton Holder without Lid



FI-11-153 Cotton Holder Estrella without Lid



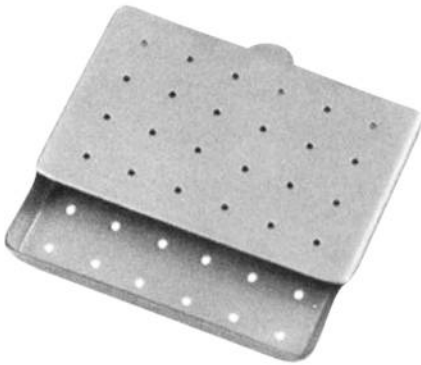
Needle Case	
<b>FI-11-154</b>	210 x 125 x 17 mm



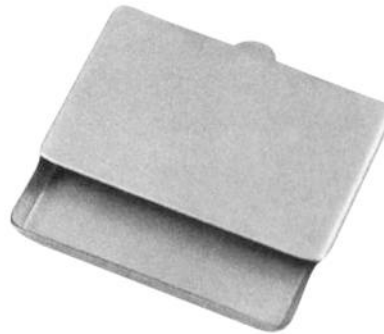
Needle Case Sauerbruch	
<b>FI-11-155</b>	210 x 125 x 17 mm



Needle Case	
<b>FI-11-156</b>	150 x 90 x 10 mm



Needle Cases Perforated	
<b>FI-11-157</b>	50 x 25 x 4.5 mm
<b>FI-11-158</b>	65 x 42 x 8 mm
<b>FI-11-159</b>	75 x 25 x 4.5 mm



Needle Cases Plain	
<b>FI-11-160</b>	50 x 25 x 4.5 mm
<b>FI-11-161</b>	65 x 42 x 8 mm
<b>FI-11-162</b>	75 x 25 x 4.5 mm



<b>FI-11-163</b>	Needle Case Complete
------------------	----------------------



Funnels	
	dia.
<b>FI-11-164</b>	100 mm
<b>FI-11-165</b>	120 mm
<b>FI-11-166</b>	150 mm
<b>FI-11-167</b>	200 mm
<b>FI-11-168</b>	240 mm



Petri Dishes	
	dia. height
<b>FI-11-169</b>	60 x 20 mm
<b>FI-11-170</b>	90 x 15 mm
<b>FI-11-171</b>	100 x 20 mm
<b>FI-11-172</b>	120 x 20 mm



Gallipot	
	vol.
FI-11-173	50 ml
FI-11-174	100 ml
FI-11-175	150 ml
FI-11-176	225 ml



Stainless Steel Round Bowls			
	dia.	height	vol.
FI-11-177	Ø 40 mm	19 mm	0.05L
FI-11-178	Ø 60 mm	30 mm	0.07L
FI-11-179	Ø 80 mm	40 mm	0.14L
FI-11-180	Ø 100 mm	50 mm	0.35L
FI-11-181	Ø 120 mm	60 mm	0.45L
FI-11-182	Ø 150 mm	70 mm	0.70L
FI-11-183	Ø 180 mm	90 mm	1.10L
FI-11-184	Ø 200 mm	100 mm	1.60L



Stainless Steel Bowls			
	dia.	height	vol.
FI-11-185	Ø 40 mm	19 mm	0.05L
FI-11-186	Ø 60 mm	30 mm	0.07L
FI-11-187	Ø 80 mm	40 mm	0.14L
FI-11-188	Ø 100 mm	50 mm	0.35L
FI-11-189	Ø 120 mm	60 mm	0.45L
FI-11-190	Ø 150 mm	70 mm	0.70L
FI-11-191	Ø 180 mm	90 mm	1.10L
FI-11-192	Ø 200 mm	100 mm	1.60L



Wash Basins	
	dia.
FI-11-193	300 mm
FI-11-194	320 mm
FI-11-195	350 mm
FI-11-196	400 mm



Medicine Cup		
	dia.	height
FI-11-197	80 x 35 mm	
FI-11-198	125 x 60 mm	



Medicine Cup (Graduated)		
	Size ( mm )	Cap.( ml )
FI-11-199	2 Oz.	60 ml



Kidney Trays With LID	
	dia.
FI-11-200	150 mm
FI-11-201	200 mm
FI-11-202	250 mm
FI-11-203	300 mm



Kidney Trays	
	dia.
FI-11-204	150 mm
FI-11-205	200 mm
FI-11-206	250 mm
FI-11-207	300 mm



Kidney Trays Shallow	
	dia.
FI-11-208	150 mm
FI-11-209	200 mm
FI-11-210	250 mm
FI-11-211	300 mm



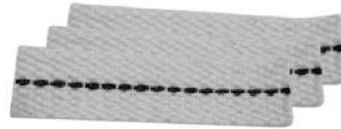
FI-11-212 Spirit Lamp 120 cc



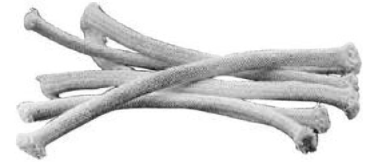
FI-11-213 Spirit Lamp 120 cc



FI-11-214 Spirit Lamp 120 cc



FI-11-215 Spare wicks Flat 13 cm (pack of 5)



FI-11-216 Spare wicks Round 13c m (pack of 5)



Forceps Jars

	dia.	height
FI-11-217	30	90 mm
FI-11-218	50	100 mm
FI-11-219	50	130 mm
FI-11-220	50	175 mm
FI-11-221	75	100 mm
FI-11-222	75	130 mm
FI-11-223	75	175 mm
FI-11-224	100	175 mm
FI-11-225	100	200 mm



Dressing Jars With Lid & Knob

	dia.	height
FI-11-226	75	60 mm
FI-11-227	75	75 mm
FI-11-228	100	60 mm
FI-11-229	100	100 mm
FI-11-230	125	80 mm
FI-11-231	125	125 mm
FI-11-232	150	150 mm



Dressing Jars / Cotton Containers

FI-11-233	80 x 60	mm
FI-11-234	80 x 80	mm
FI-11-235	100 x 60	mm
FI-11-236	100 x 80	mm
FI-11-237	100 x 100	mm
FI-11-238	120 x 80	mm
FI-11-239	120 x 100	mm
FI-11-240	120 x 120	mm
FI-11-241	150 x 100	mm
FI-11-242	150 x 150	mm
FI-11-243	180 x 150	mm
FI-11-244	180 x 180	mm
FI-11-245	200 x 200	mm
FI-11-246	240 x 240	mm





Irrigators	
	vol.
FI-11-247	1.0L
FI-11-248	1.5L
FI-11-249	2.0L



Measuring Jugs	
	vol.
FI-11-250	250 ml
FI-11-251	500 ml
FI-11-252	1000 ml
FI-11-253	2000 ml



Measuring Jugs	
	vol.
FI-11-254	250 ml
FI-11-255	500 ml
FI-11-256	1000 ml
FI-11-257	2000 ml



Buckets With LID		Buckets Without LID	
	vol.		vol.
FI-11-258	8.0L	FI-11-261	8.0L
FI-11-259	10.0L	FI-11-262	10.0L
FI-11-260	15.0L	FI-11-263	15.0L



Sputum Cup	
	dia. height
FI-11-264	Ø 75 x 80 mm
FI-11-265	Ø 100 x 50 mm
FI-11-266	Ø 100 x 80 mm



Ointment Jar		
	dia. height	Vol.
FI-11-267	Ø 75 x 65 mm	250ml



Urinal Jugs		
FI-11-268	Horizontal	115 x 230 mm
FI-11-269	Vertical Junior	95 x 205 mm
FI-11-270	Vertical Adult	100 x 225 mm



FI-11-271 Male Urinal



FI-11-272 Urinal Female 1200 ml



Bed Pan	
	dia.
FI-11-273	235 mm
FI-11-274	320 mm



Bed Pan	
	dia.
FI-11-275	235 mm
FI-11-276	320 mm



FI-11-277 Bed Pan



FI-11-278 American Pattern Bed Pan Adult



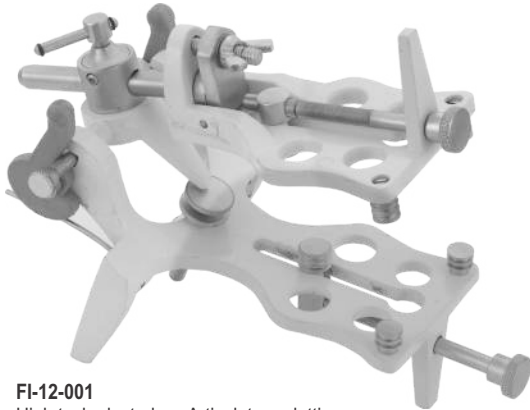
Sterilizing Drums		
	dia.	height
FI-11-279	Ø 80	x 80 mm
FI-11-280	Ø 105	x 120 mm
FI-11-281	Ø 140	x 140 mm
FI-11-282	Ø 160	x 120 mm
FI-11-283	Ø 160	x 150 mm
FI-11-284	Ø 190	x 150 mm
FI-11-285	Ø 190	x 190 mm
FI-11-286	Ø 240	x 160 mm
FI-11-287	Ø 240	x 240 mm
FI-11-288	Ø 290	x 160 mm
FI-11-289	Ø 290	x 240 mm
FI-11-290	Ø 340	x 160 mm
FI-11-291	Ø 340	x 340 mm
FI-11-292	Ø 390	x 190 mm
FI-11-293	Ø 380	x 290 mm



12

Page 155-157

Articulators

**FI-12-001**

High tech plasterless Articulator galetti with adjustable screws at rears & front. All anatomical Movements Possible. Also available in vibratory polished

**FI-12-002**

Pro Tamahachi Articulator Standard arcon yamahachi type Articulator with A ball slot type path on the maxillary frame

**FI-12-003**

Semi anatomical silver Articulator high tech. Adjustable back rod by registration screw to work without incisal rod by keeping constant trajectories and inclinations during side and back/forward movements. Pure translation movement anti-shock hinge rod in case Articulator falls accidentally. Bigger size lock screws for mounting plates

**FI-12-004**

Gnatus Pro Jp30 Articulator best performance with an excellent degree of accuracy. Its functionality makes easier both the procedures of taking & transferring the patient's records & the process of mounting the models

**FI-12-005**

Magic Art-II Articulator high tech. Adjustable back lightweight, high-quality magic Art Articulator securely holds quadrant models, conserve materials & time! Quickly & Easily mouth pre-cast dental models with the high quality

**FI-12-006**

Vibratory polished wire Articulator - Made of stainless steel & die cast aluminum



**FI-12-007**  
Articulator ASA W/out bearing rod.  
Anatomical articulator with incisive pin.  
4 mounting plates and Supporting back pin.  
Available in assorted colors



**FI-12-008**  
ASA Articulator with lateral moment.  
Made of aluminum die casting with  
2 Mounting Plates. Also Available in  
vibratory polished process & Assorted colors



**FI-12-009**  
Keystone deluxe magnetic denture  
articulator with plates, Interchangeable,  
Incisal pin Included. Magnetic Split Casting  
ensures Easy & Exact Setting, Lateral  
excursions



**FI-12-010**  
Keystone deluxe universal type-A Articulator.  
Interchangeable, Included Incisal pin, Lateral  
excursions



**FI-12-011**  
Anatomical Articulator Universal,  
Realized for easy visibility to the lingual surface  
& for A perfect stability Also In reserved position.  
(Also available in assorted colors)



**FI-12-012**  
Chromium plated fork  
Fork Crowned Bridge.  
Nickle chromium plated articulator

**FI-12-013**

Full arch hinged articulator  
chromium plated hinge articulator  
for mounting full arch cases.  
Low back gypsum-free articulation enables  
clean & accurate mounting & dismounting  
in 30 seconds

**FI-12-014**

Ray foster 57 chrome articulator  
chrome brass hinge crowned bridge  
articulator for mounting quadrant cases.  
Crown & bridge articulator is popular ray  
foster # 57 design,  
eliminates the need to break off models

**FI-12-015**

Occlusor, wire articulator,  
Available in 2 sizes,  
Small & Large

**FI-12-016**

Professional occlusor.  
Vibratory polished articulator.

**FI-12-017**

Dental articulator 2x-cresant brand  
full denture chromium plated articulator.  
Provides additional vertical dimension for  
acceptance of higher models. 49 wide at  
the joint & has a vertical span between  
parallel bows of 25/8"

**FI-12-018**

Hinge articulator full arch  
plain line nickle chromium  
plated articulator

**FI-12-019**

Magic Art-I articulator lightweight

**FI-12-020**

Mortimer-I oculader articulator  
All filled with high carbon Steel balls.  
Also available in gold plated

**FI-12-021**

Mortimer-II oculader articulator  
Also available in gold plated

British Pattern



# Professional **DENTAL** Instruments Range



+92 (309) 869 6436



[www.fisoninstruments.com](http://www.fisoninstruments.com)



[info@fisoninstruments.com](mailto:info@fisoninstruments.com)



Main Road, Fateh Garh, Sialkot - 51310 Pakistan

